



PERU

Ministerio de la Producción



FONDEPES
Fondo Nacional de Desarrollo Pesquero

"Decenio de la Igualdad de Oportunidades para Mujeres y Hombres"
"Año de la lucha contra la Corrupción y la Impunidad"

MEMORANDO N° 1016 - 2019-FONDEPES/DIGENIPAA

CARGO

A : Sra. CPC TERESA ZENaida QUIROZ SILVA
Jefe de la Oficina General de Administración

ASUNTO : **Solicitud de Pago de Valorización de Obra N° 18**
Licitación Pública N° 0001-2017-FONDEPES
Contrato N° 025-2017-FONDEPES
Obra: MEJORAMIENTO Y RECUPERACION DE LOS SERVICIOS DEL
DESEMBARCADERO PESQUERO ARTESANAL DE SUPE, DISTRITO DE SUPE
PUERTO, PROVINCIA DE BARRANCA, REGION LIMA"

REFERENCIA : a) Carta CSL.174302.PU.DPA.S.324.19 e Informe de la supervisión CESEL SA.
b) Carta CSL.174302.PU.DPA.S.320.19.
c) Carta N° C058-2019-CMN-SUPE y Expediente de Valorización de Obra N° 18.
d) Informe N° 45-2019-FONDEPES/DIGENIPAA/AOEM/LATH

FECHA : Lima, **11 MAR 2019**

Me dirijo a usted para solicitar se sirva ordenar a quien corresponda el trámite de pago de la Valorización de Obra N° 18 correspondiente a los avances del mes de febrero del 2019, por la suma de **S/. 159,807.29 (Ciento Cincuenta y Nueve Mil, Ochocientos Siete con 29/100 Soles)** incluido el IGV, a favor del Contratista CONSORCIO MARITIMO DEL NORTE, responsable de la ejecución de la Obra "MEJORAMIENTO Y RECUPERACION DE LOS SERVICIOS DEL DESEMBARCADERO PESQUERO ARTESANAL DE SUPE, DISTRITO DE SUPE PUERTO, PROVINCIA DE BARRANCA, REGION LIMA".

Para el trámite correspondiente, se adjunta a la presente los documentos indicados en la referencia a), b) c) y d).

Sin otro particular, hago propicia la oportunidad para expresarle el sentimiento de mi especial consideración y estima personal.

Atentamente,



FONDEPES

Ing. Luis Alberto Barberi Quino
Director General de Inversión
Pesquera Artesanal Y Acuicola

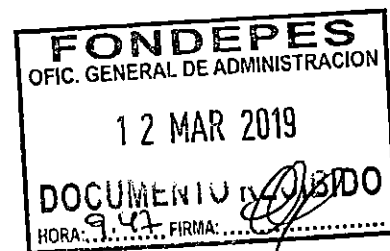

LABQ/LATH

CONFORMIDAD DEL GASTO

Conste por el presente documento que, el Director General de Inversión Pesquera Artesanal y Acuícola al suscribir el mismo, da su conformidad para realizar el pago por el concepto de la **Valorización de Obra N° 18**, correspondiente al mes de febrero del 2019 por la suma de **S/. 159,807.29 (Ciento Cincuenta y Nueve Mil, Ochocientos Siete con 29/100 Soles)** a favor del contratista **CONSORCIO MARITIMO DEL NORTE**, encargado de la ejecución de la obra: **"MEJORAMIENTO Y RECUPERACION DE LOS SERVICIOS DEL DESEMBARCADERO PESQUERO ARTESANAL DE SUPE, DISTRITO DE SUPE PUERTO, PROVINCIA DE BARRANCA, REGION LIMA"**, resultado de la **LICITACIÓN PÚBLICA N° 0001-2017-FONDEPES** – Primera Convocatoria y según Contrato N° 025-2017 FONDEPES.

Lima, **11 MAR 2019**



FONDEPES

.....
Ing. Luis Alberto Barbieri Quino
Director General de Inversión
Pesquera Artesanal Y Acuicola

"Decenio de la Igualdad de Oportunidades para Mujeres y Hombres"
"Año de la lucha contra la Corrupción y la Impunidad"

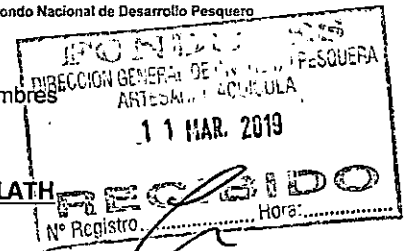

INFORME N° 45-2019-FONDEPES-DIGENIPAA/AOEM/LATH

Atención : **ING. LUIS ALBERTO BARBIERI QUINO**
Director General de Inversión Pesquera, Artesanal y Acuicola

Asunto : **Valorización de Obra N° 18 – febrero 2019 - DPA Supe:**
LICITACION PUBLICA N° 0001-2017-FONDEPES.

Referencia : a) Memorándum Interno N° 917-2019-FONDEPES/DIGENIPAA/AOEM
b) Memorándum Interno N° 1583-2019-FONDEPES/DIGENIPAA
c) Carta CSL.174302.PU.DPA.S.324.19 e Informe de CESEL SA
d) Carta C058-2019-CMN-SUPE y Expediente de Valorización N° 18.
e) CONTRATO N° 025-2017-FONDEPES del Contratista.

Fecha : Marzo, 07 del 2019.

De mi consideración:

Es grato dirigirme a usted para remitir el presente Informe con la finalidad de solicitarle se sirva dar trámite a la Valorización de la Obra N° 18 del mes de febrero del 2019 por la ejecución de la obra: "Mejoramiento y Recuperación de los Servicios del Desembarcadero Pesquero Artesanal de Supe, Distrito de Supe Puerto, Provincia de Barranca, Región Lima" a cargo del contratista CONSORCIO MARITIMO DEL NORTE. Al respecto, puedo informar.

I. DATOS GENERALES DE LA OBRA

Proceso : L.P. N° 0001-2017-FONDEPES (1ra. Convocatoria)
Código SNIP N° : 182813
Contrato : N° 025-2017-FONDEPES
Obra : "Mejoramiento y Recuperación de los Servicios del Desembarcadero Pesquero Artesanal de Supe, Distrito de Supe Puerto, Provincia de Barranca, Región Lima".

Sistema : A precios Unitarios
Monto Obra : S/. 21'509,091.48 (incluye IGV)
Adic. Obra 01 : S/. 2'213,942.02 – R.J. N° 008-2018-FONDEPES/J del 18.01.18
Deduc. Vinc. 01 : S/. -1'879,271.36
Adic. Obra 02 : S/. 160,884.74 – R.J. N° 052-2018-FONDEPES/J del 18.05.18
Adic. Obra 03 : S/. 676,072.37 – R.J. N° 094-2018-FONDEPES/J del 22.08.18
Deduc. Vinc. 02 : S/. -242,870.31
Adic. Obra 04 : S/. 417,954.90 – R.J. N° 095-2018-FONDEPES/J del 22.08.18
Deduc. Vinc. 03 : S/. -220,209.97
Adic. Obra 05 : S/. 562,775.06 – R.J. N° 133-2018-FONDEPES/J del 26.10.18
Deduc. Vinc. 04 : S/. -187,675.96
Adic. Obra 06 : S/. 340,246.17 – R.J. N° 158-2018-FONDEPES/J del 28.12.18
Deduc. Vinc. 05 : S/. -339,697.56
Total Adicional : S/. 1'502,150.10 (6.98%)



"Decenio de la Igualdad de Oportunidades para Mujeres y Hombres"
"Año de la lucha contra la Corrupción y la Impunidad"

Monto Vigente : S/. 23'011,241.58 (incluye IGV)
 Contratista : CONSORCIO MARITIMO DEL NORTE
 Residente : Ing. Daniel J. Morales Vivanco.
 Supervisión : CESEL S.A.
 Supervisor : Ing. Ludwing Carrasco Bustamante
 Fecha de Inicio : 19 de setiembre del 2017
 Plazo Ejecución : 270 días calendario
 Término : 15 de junio del 2018
 Ampliac. N° 03 : 42 d.c. (Aprobada con Resolución de S.G. N° 028-2018-FONDEPES/SG).
 Término : 27 de julio del 2018.
 Ampliac. N° 04 : 32 d.c. (Aprobada con Resolución de S.G. N° 029-2018-FONDEPES/SG).
 Término : 28 de agosto del 2018.
 Ampliac. N° 05 : 28 d.c. (Aprobada con Resolución de S.G. N° 110-2018-FONDEPES/SG)
 Término : 25 de setiembre del 2018.
 Ampliac. N° 08 : 52 d.c. (Aprobada con Resolución de S.G. N° 171-2018-FONDEPES/SG).
 Término : 16 de noviembre del 2018.
 Ampliac. N° 10 : 44 d.c. Resolución de S.G. N° 215-2018-FONDEPES/SG del 30.11.2018.
 Fecha Término : 30 de diciembre del 2018
 Ampliac. N° 14 : 75 d.c. Resolución de S.G. N° 13-2019-FONDEPES/SG del 21.01.2019.
 Fecha Término : 15 de marzo del 2019

II. CONTROL DE FIANZAS

ITEM	CONCEPTO	DATOS	FECHA DE VENCIMIENTO	CHECK
1	FIEL CUMPLIMIENTO	AVLA PERU S/. 2'150,909.15 C/F N° 3002017003161-3	02/ABRIL/2019 RENOVADA	✓
2	ADELANTO DIRECTO	BANBIF S/. 1'207,876.95 C/F N° 4410069432.06	08/JUNIO/2019 RENOVADA	✓
3	ADELANTO MATERIALES 01	BANBIF S/. 1'000,000.00 C/F N° 8488-0	24/MARZO/2018 AMORTIZADA Y DEVUELTA	✓
4	ADELANTO MATERIALES 02	AVLA PERU S/. 439,685.96 C/F N° 3002017004186-7	04/JUNIO/2019 RENOVADA	✓
5	ADELANTO MATERIALES 03	A) BANBIF S/. 667,500.00 C/F N° 4410070681.04 B) BANCO BCP S/. 200,000.00 N° D193-01808214 B) BANCO BANBIF S/. 460,000.00 N° 4410074892.00	06/MARZO/2019 RENOVADA 14/MARZO/2019 RENOVADA 14/MARZO/2019 RENOVADA	✓



"Decenio de la Igualdad de Oportunidades para Mujeres y Hombres"
"Año de la lucha contra la Corrupción y la Impunidad"

III. RESUMEN DE LA VALORIZACION DE OBRA N° 18 – FEBRERO 2019.

DESEMBARCADERO PESQUERO ARTESANAL DE SUPE

DESCRIPCION	MONTO PRESUPUESTO (SIIGV)	VALORIZACION (S/.)			SALDOS (S/.)
		ANTERIOR	ACTUAL	ACUMULADO	
A. VALORIZACION ACTUAL					
FP No 1 OBRAS PORTUARIAS	8,897,118.06	3,275,986.87	178,769.65	3,454,756.52	5,442,361.54
FP No 2 ESTRUCT. EN TIERRA-ESTRUCTURAS	3,691,408.51	2,834,424.51	17,206.86	2,851,631.37	839,777.14
FP No 3 ESTRUCT. EN TIERRA-ARQUITECTURA	1,738,221.23	566,042.54	77,103.99	643,146.53	1,095,074.70
FP No 4 ESTRUCT. EN TIERRA-INST. ELECTRICAS	653,003.57	35,414.49	0.00	35,414.49	617,589.08
FP No 5 ESTRUCT. EN TIERRA-INST. SANITARIAS	820,930.60	107,418.47	-8,217.99	99,200.48	721,730.12
FP No 6 ESTRUCT. EN TIERRA-EQUIPAMIENTO	2,373,404.06	1,378,948.60	0.00	1,378,948.60	994,455.46
FP No 7 IMPACTO AMBIENTAL DEDUCTIVOS DE OBRA	53,957.61	38,064.33	0.00	38,064.33	15,893.28
TOTAL (A)	15,796,073.16	8,236,299.81	264,862.51	8,501,162.32	7,294,910.84
AVANCE EJECUTADO		52.14%	1.68%	53.82%	46.18%
AVANCE PROGRAMADO VIGENTE		100.00%	0.00%	100.00%	
B. REAJUSTES					
OBRAS PORTUARIAS		88,549.95	15,253.00	103,802.95	
ESTRUCT. EN TIERRA-ESTRUCTURAS		76,151.78	1,130.46	77,282.24	
ESTRUCT. EN TIERRA-ARQUITECTURA		36,760.71	5,788.58	42,549.29	
ESTRUCT. EN TIERRA-INST. ELECTRICAS		-25,784.02	0.00	-25,784.02	
ESTRUCT. EN TIERRA-INST. SANITARIAS		18,606.67	-1,463.55	17,143.12	
ESTRUCT. EN TIERRA-EQUIPAMIENTO		12,173.66	0.00	12,173.66	
IMPACTO AMBIENTAL		442.30	0.00	442.30	
TOTAL (B)		206,901.05	20,708.49	227,609.54	
VALORIZACION BRUTA (VB = A + B)		8,443,200.86	285,571.00	8,728,771.86	
C. DEDUCCIONES					
DEDUCCION ADELANTO EN EFECTIVO		16,581.92	1,840.77	18,422.69	
DEDUCCION ADELANTO POR MATERIALES		50,020.02	8,815.81	58,835.83	
TOTAL (C)		66,601.94	10,656.58	77,258.52	
D. AMORTIZACIONES					
AMORTIZ. DEL ADELANTO EN EFECTIVO	1,822,804.36	884,928.51	32,842.94	917,771.45	905,032.91
AMORTIZ. DEL ADELANTO POR MATERIALES	3,031,779.66	1,768,299.53	106,641.58	1,874,941.11	1,156,838.55
Adelanto de Materiales N° 01	847,457.63	847,457.63	0.00	847,457.63	0.00
Adelanto de Materiales N° 02	1,059,322.03	920,841.90	106,641.58	1,027,483.48	31,838.55
Adelanto de Materiales N° 03	1,125,000.00	0.00	0.00	0.00	1,125,000.00
TOTAL (D)	4,854,584.02	2,653,228.04	139,484.52	2,792,712.56	2,061,871.46
VALORIZACION NETA (VN = VB - D - C)		5,723,370.88	135,429.90	5,858,800.78	
E. MONTO A PAGAR AL CONTRATISTA					
VALORIZACION NETA		5,723,370.88	135,429.90	5,858,800.78	
EN I.G.V. (18% VN)		1,030,206.78	24,377.39	1,054,584.17	
TOTAL (E)		6,753,577.66	159,807.29	6,913,384.95	
LIQUIDO A PAGAR AL CONTRATISTA S/.		6,753,577.66	159,807.29	6,913,384.95	



"Decenio de la Igualdad de Oportunidades para Mujeres y Hombres"
"Año de la lucha contra la Corrupción y la Impunidad"

IV. ANALISIS

- ✓ Con Carta CSL.174302.PU.DPA.S.320.19 del 05 de marzo del 2019 la supervisión la remite la Carta C058-2019-CMN-SUPE del 28 de febrero del 2019 adjuntando el expediente de Valorización de Obra N° 18 elaborado por el contratista Consorcio Marítimo del Norte, quien solicita un monto de S/. 352,450.26.
- ✓ Con Carta CSL.174302.PU.DPA.S.324.19 del 05 de marzo del 2019 e Informe respectivo, la supervisión CESEL SA elabora y remite al FONDEPES la Valorización de Obra N° 18 del mes de febrero del 2019 por un monto de S/. 159,807.29 incluido el IGV, por la ejecución de la obra del DPA de Supe a cargo del contratista CONSORCIO MARITIMO DEL NORTE.
- ✓ Las cartas fianzas por el adelanto de materiales N° 03 del Banco BANBIF por S/. 667,500.00, ha vencido el 06.03.19 por lo que se debe solicitar la renovación para proceder con el pago de la presente valorización.
- ✓ Los trabajos se tienen un desarrollando a un ritmo normal en las edificaciones de las obras de tierra. Esta pendiente el inicio de los trabajos en el muelle por permiso de DICAPI Supe.
- ✓ En lo que respecta a las deducciones por penalidades y otras penalidades serán deducidas en la liquidación de la obra.

V. CONCLUSIONES Y RECOMENDACIONES

- ✓ Se recomienda proceder con el trámite de pago de la Valorización N° 18 correspondiente al mes de febrero del 2019 por un monto de S/. 159,807.29 (Ciento Cincuenta y Nueve Mil, Ochocientos Siete con 29/100 Soles), incluido el IGV; al contratista CONSORCIO MARITIMO DEL NORTE por ejecución de la obra: "MEJORAMIENTO Y RECUPERACION DE LOS SERVICIOS DEL DESEMBARCADERO PESQUERO ARTESANAL DE SUPE, DISTRITO DE SUPE PUERTO, PROVINCIA DE BARRANCA, REGION LIMA", previa renovación de las cartas fianzas por el adelanto de materiales N° 03.

Es cuanto informo a Usted para su conocimiento y fines

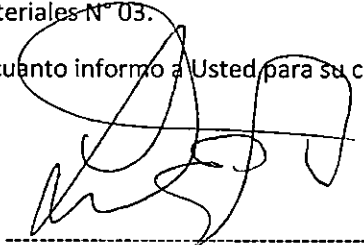

Ing. Luis Alberto Tello Hidalgo.
CIP N° 39250

El coordinador del Área de Obras que suscribe hace suyo el documento.



Ing. Badur Huamán Cornejo
Coordinador (e) del Área de Obras
Equipamiento y Mantenimiento



"Decenio de la Igualdad de Oportunidades para Mujeres y Hombres"
"Año de la lucha contra la corrupción y la impunidad"



04855805

Usuario: pruiz
Fecha: 08/03/2019
Hora: 10:16



CARGO 00598-2019-FONDEPES/AOEM

A: MORGAN LEON MAGALI

Asunto: CSL-174302-PU-DPA-S-324-2019
REMITE VALORIZACIÓN DE OBRA N° 18 ELABORADA POR LA SUPERVISION CORRESPONDIENTE AL MES DE FEBRERO 2019 REF: DPA SUPE

Referencia: INFORME 00045-2019-FONDEPES/LTH

Fecha: 08/03/2019

Observación: SE ADJUNTA PROYECTO DE MEMO A OGA



AREA DE OBRAS, EQUIPAMIENTO Y MANTENIMIENTO



"Decenio de la Igualdad de Oportunidades para Mujeres y Hombres"
"Año de la lucha contra la corrupción y la impunidad"



04856793

Usuario: usuario_digenipaa3
Fecha: 11/03/2019
Hora: 15:56



CARGO 00068-2019-FONDEPES/MML

A: DIRECCION GENERAL INVERSION PESQUERA ARTESANAL Y ACUICOLA

Asunto: CSL-174302-PU-DPA-S-324-2019
REMITE VALORIZACIÓN DE OBRA N° 18 ELABORADA POR LA SUPERVISION CORRESPONDIENTE AL MES DE FEBRERO 2019 REF: DPA SUPE

Referencia:

Fecha: 11/03/2019

Observación: SE DERIVA PARA TRAMITE, S/ 159,807.29, DPA SUPE, VALORIZACIÓN 18, FEBRERO 2019. PROVEEDOR CONSORCIO MARÍTIMO DEL NORTE. CONTRATO 25-2017
COORDINADOR ING. LUIS TELLO
INFORME 45-2019-LATH

Atentamente,

MORGAN LEÓN MAGALI

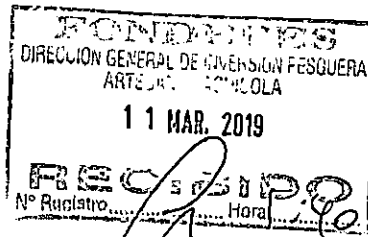

Lima, 05 de marzo de 2019

CSL.174302.PU.DPA.S.324.19

Señores:

FONDO NACIONAL DE DESARROLLO PESQUERO - FONDEPES

Av. Petit Thouars N° 115 - Cercado de Lima

Lima.-

Atención : **Ing. Luis Alberto Barbieri Quino**
Director General de Inversión Pesquera Artesanal y Acuícola

Asunto : **Valorización de Obra N° 18 elaborada por la Supervisión correspondiente al mes de febrero del 2019**

Referencia : Contrato N° 30-2017- FONDEPES/OGA Supervisión de la Ejecución de la Obra: "Mejoramiento y recuperación de los servicios del Desembarcadero pesquero artesanal de Supe", Provincia de Barranca, Región de Lima.

a) C058-2019-CMN-SUPE (28-FEB-2019)

De mi consideración:

Es grato dirigirnos a usted, para saludarlo y hacerle llegar la Valorización de Obra N° 18 elaborada por la Supervisión, correspondiente al mes de febrero del 2019 de la Obra "Mejoramiento y recuperación de los servicios del Desembarcadero pesquero artesanal de Supe".

La valorización del Contratista fue elaborada con metrados no conciliados con la Supervisión y presentados con el documento a) de la referencia.

Agradeciendo la atención a la presente, nos despedimos.

Atentamente,

.....
LUDWING CARRASCO BUSTAMANTE
Ing. Supervisor - CIP 79040
CESEL S.A.

FONDO NACIONAL DE DESARROLLO PESQUERO	
	
2840791	
N° DOC:	00002085-2019
CLAVE:	8610
USUARIO:	usuario_alog69
FECHA Y HORA:	05/03/2019 16:41:18
TELEFONO:	2097700
www.fondepes.gob.pe	

Av. José Gálvez Barrenechea 646
San Isidro - Lima 27 - Perú
Telf: (51-1) 705-500
cesel@cesel.com.pe
www.cesel.com.pe

VALORIZACIÓN DE OBRA N° 18 – FEBRERO 2019

INDICE

1.	OBJETO.....	2
2.	ANTECEDENTES	2
3.	DESCRIPCION DE LA OBRA	3
4.	DATOS GENERALES DE LA OBRA.....	5
5.	ANÁLISIS.....	7
6.	AVANCE FINANCIERO MENSUAL DE LA OBRA	8
7.	SITUACIÓN DE LA OBRA.....	8
8.	CONCLUSIONES.....	9
9.	RECOMENDACIONES.	9

LUDWING CARRASCO BUSTAMANTE
Ing. Supervisor - CIP 79040
CESEL S.A.

1. OBJETO

El presente informe tiene por objeto presentar la Valorización de Obra N° 18 correspondiente al mes de febrero del 2019, ejecutados por el contratista CNM, en donde se muestran los metrados de avance de obra de cada una de las partidas valorizadas en el presente período.

Asimismo, de verificar la información presentada por el Contratista y se efectúan las precisiones correspondientes.

2. ANTECEDENTES

El desembarcadero pesquero de Supe es uno de los más antiguos de la costa peruana. En el año 1993, en el gobierno del Ing. Alberto Fujimori, se construye el DPA de Supe implementándose el ambiente de la planta de frío y se equipa con una cámara de frío de 10Tn y un productor de hielo en bloque, así mismo se construye el muro perimétrico.

En el año 2006, FONDEPES realiza un diagnóstico de este desembarcadero para determinar la situación en la que venía funcionando. Este mismo año, ante la evaluación de los desembarcaderos pesqueros artesanales a lo largo de la costa que realiza la sanitaria pesquera nacional (SANIPES), con la finalidad de verificar el cumplimiento de las normas sanitarias pesqueras del desembarcadero pesquero artesanal de Supe, la declara observada por el incumplimiento de las Normas Sanitarias de las Actividades Pesqueras y Acuícolas.

En el año 2007 se elabora un estudio con el nombre de Mejoramiento Integral del Desembarcadero Pesquero Artesanal Supe, Región Lima, Provincia de Barranca, Distrito de Supe.

Mediante el informe técnico N°030-2014-PRODUCE/OGPP/OPI y LOPEZ – JVALDIVIA la Oficina de Programación de Inversiones del Sector Producción (OPI-PRODUCE) en su calidad de responsable de la evaluación de proyectos de pre inversión del sector producción, luego del proceso de evaluación y análisis técnico- económica correspondiente Aprobó el estudio de pre inversión a nivel de Factibilidad del proyecto de inversión Pública: "MEJORAMIENTO Y RECUPERACIÓN DE LOS SERVICIOS DEL DESEMBARCADERO PESQUERO ARTESANAL DE SUPE, DISTRITO DE SUPE PUESTO, PROVINCIA DE BARRANCA, REGIÓN LIMA" y declara la viabilidad del mismo.

El 06 de febrero del 2019 mediante carta, el contratista entrega la valorización N° 17 que corresponde a los avances al mes de enero del 2019. Debido a la tardanza en la entrega de la valorización por parte del contratista, la Supervisión ha elaborado la presente valorización con los metrados entregado por el contratista conciliados parcialmente.

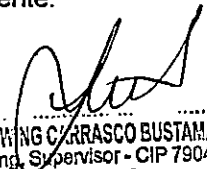
.....
LUDWING CARRASCO BUSTAMANTE
Ing. Supervisor - CIP 79040
CESEL S.A.

3. DESCRIPCIÓN DE LA OBRA

El proyecto MEJORAMIENTO Y RECUPERACIÓN DE LOS SERVICIOS DEL DESEMBARCADERO PESQUERO ARTESANAL DE SUPE, REGIONA LIMA, PROVINCIA DE BARRANCA, DISTRITO DE SUPE PUERTO, diseñado para desembarcar y procesar en condiciones adecuadas los productos hidrobiológicos de la pesca artesanal, de acuerdo a la normatividad sanitaria vigente sin generar impactos negativos al medio ambiente.

Las metas físicas se detallan a continuación:

ARQUITECTURA Y ESTRUCTURAS EN TIERRA

Las metas físicas de arquitectura y estructuras en tierra tienen como fin común la construcción de:

Zona 01 - Embarque y desembarque:

De dominio de los pescadores, ubicada tangencialmente a la zona de Tareas Previas, involucra desde el ingreso al D.P.A, vía de circulación, 1 muelles marginal de 59.0 ml de cabezo y muelle espigón de 20.00 ml de longitud, transporte de la producción hidrobiología en el patio de maniobras considerando solo el embarque en camiones frigoríficos, y estacionamiento temporal de los carros frigoríficos.

Zona 02 – Tareas Previas y Despacho:

De dominio exclusivo de los Procesadores Primarios, operarios de hielo, y peones de lavado de cajas; con control sanitaria, higiénico y administrativo, ubicado en la parte central de la plataforma del D.P.A., colindante a la zona de embarque y desembarque.

El acceso a esta zona es restringido por medidas sanitarias normadas en el D.S. 040-2001-PE y complementadas por el Reglamento Nacional de Edificaciones según la NORMA A.010 y la NORMA E.060.

Zona 03 – Servicios Complementarios:

La zona de servicios complementarios según las actividades específicas, van desde un dominio común, dominio restringido, y dominio exclusivo, consecuentemente el acceso a estos dependerá del grado de dominio específico.

Su ubicación dependerá de la complementariedad a las zonas 01 y 02, por lo que se distribuyen en diferentes zonas del D.P.A

OBRAS PORTUARIAS

Desarrollar un estudio técnico en el actual desembarcadero, en su posición actual, desplazando el cabezo hacia el norte y profundizado el muelle hacia el mar, hasta alejarse de la rompiente, para un horizonte de los siguientes 20 años.

Un área en tierra para el manipuleo, almacenamiento y comercialización de los productos hidrobiológicos.

Un área en el mar para el desembarco, recepción de los productos de pesca en el mar y la atención de los servicios para las embarcaciones pesqueras

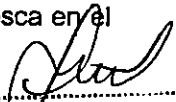
LUDWIG ZARRASCO BUSTAMANTE
Ing. Supervisor - CIP 79040
CESEL S.A.

Una zona de estacionamiento, parqueo o fondeo de las embarcaciones o lanchas utilizadas para la pesca, para actividades de descanso, reparaciones y/o esperand bye.

Los parámetros, que se requiere definir relativo a estos requerimientos son:

Las embarcaciones pesqueras, lanchas para los cuales está diseñado el muelle son:

Lanchas de 30 BRT, con las siguientes características:

Eslora total : 16.30 m
Manga máxima : 5.20 m
Calado : 2.20 m
Volumen bodega : 30 m3 equivalente a 18 t. de pescado.

Lanchas espineleras de 10 BRT, con las siguientes características:

Eslora total : 9.0 m
Manga máxima : 3.3 m
Calado : 1.2 m
Volumen bodega : 10 m3 equivalente a 6 t. de pescado.

Lanchas cortineras de 2 BRT, con las siguientes características:

Eslora total : 5.50 m
Manga máxima : 1.80 m Calado: 0.6 m
Volumen bodega : 2 m3 equivalente a 1.0 t. de pescado.2.6.3

LUDWIG CARRASCO BUSTAMANTE
Ing. Supervisor - CIP 79040
CESEL S.A.

4. DATOS GENERALES DE LA OBRA

Entidad	: FONDEPES
Domicilio	: Av. Petit Thouars 110-115, Distrito de Lima
Nombre de la obra	: "MEJORAMIENTO Y RECUPERACIÓN DEL DESEMBARCADERO PESQUERO ARTESANAL DE SUPE, REGIÓN LIMA "
SNIP	: 309752
Consultor	: CONSORCIO MARITIMO DEL NORTE
Ubicación	
Departamento	: Lima
Provincia	: Barranca
Distrito	: Supe
Localidad	: Lima
Fecha de entrega de terreno	: 06 de septiembre del 2017.
Fecha de inicio	: 19 de septiembre del 2017.
Fecha Término Contractual	: 15 de Junio del 2018
Ampliación de Plazo N° 1	: Denegada
Ampliación de Plazo N° 2	: Denegada
Ampliación de Plazo N° 3	: 42 d.c. – Resol N° 028-2018-FONDEPES/sg
Ampliación de Plazo N° 4	: 32 d.c. – Resol N° 029-2018-FONDEPES/sg
Ampliación de Plazo N° 5	: 28 d.c. – Resol N° 110-2018-FONDEPES/sg
Ampliación de Plazo N° 6	: Denegada
Ampliación de Plazo N° 7	: Denegada
Ampliación de Plazo N° 8	: 52 d.c. – Resol N° 171-2018-FONDEPES/sg
Ampliación de Plazo N° 9	: Denegada
Ampliación de Plazo N° 10	: 44 d.c. – Resol N° 215-2018-FONDEPES/sg
Ampliación de Plazo N° 14	: 75 d.c. – Resol N° 013-2019-FONDEPES/sg
Nueva Fecha de Término	: 15 de Marzo del 2019
Financiamiento	: Recursos Ordinarios
Monto Referencial (c/IGV)	: S/. 21'509,091.5PEN
Monto Referencial (c/IGV) Supervision	: S/. 1'651,890.27PEN
Prestación Adicional N° 1 Superv.	: S/. 104,435.90 incluido el IGV, aprobado con Resolución N° 105-2018-FONDEPES/OGA
Prestación Adicional N° 2 Superv.	: S/. 88,931.23 incluido el IGV, en trámite.
Prestación Adicional N° 3 Superv.	: S/. 69,657.47 incluido el IGV, aprobado con Resolución N° 136-2018-FONDEPES/OGA
Prestación Adicional N° 4 Superv.	: S/. 113,450.81 incluido el IGV, aprobado con Resolución N° 202-2018-FONDEPES/OGA
Coordinador de obra	: Ing. Luis Tello Hidalgo - FONDEPES
Supervisor de obra	: Ing. Ludwing Carrasco Bustamante – CESEL
Datos de Adicionales y deductivos	: Se adjunta cuadro

000071

SERVICIO DE SUPERVISIÓN DE LA OBRA:
"MEJORAMIENTO Y RECUPERACIÓN DE LOS SERVICIOS DEL DESEMBARCADERO PESQUERO ARTESANAL DE SUPE, DISTRITO DE SUPE PUERTO, PROVINCIA DE BARRANCA, REGIÓN LIMA"

1) DATOS ECONÓMICOS DE LA OBRA	PTO TOTAL	SIN I.G.V.	Costo Directo	Gastos Generales	Utilidad
Monto Contratado Con I. G. V.	S/21,509,091.48	S/18,228,043.63	S/14,891,412.65	S/2,990,781.01	S/345,849.97
Adicional 01 - Terraplén y Enrocado	S/2,213,942.02	S/1,876,222.05	S/1,813,610.56	S/20,490.76	S/42,120.73
Deductivo 01 afectó a Portuarias	-S/1,879,271.36	-S/1,592,602.85	-S/1,556,454.52	S/0.00	-S/36,148.33
Adicional 02 - Movimiento de tierra y Falsa zapata	S/160,884.74	S/136,343.00	S/111,385.50	S/22,370.60	S/2,586.90
Adicional 03 - IEE	S/676,072.37	S/572,942.69	S/468,085.92	S/84,006.04	S/10,870.73
Deductivo 02 afectó a Tierra	-S/242,870.30	-S/205,822.29	-S/168,146.66	-S/33,770.46	-S/3,905.17
Adicional 04 - ISS	S/417,954.90	S/354,199.07	S/289,363.17	S/58,115.50	S/6,720.40
Deductivo 03 afectó a Tierra	-S/220,209.97	-S/186,618.62	-S/152,458.21	-S/30,619.60	-S/3,540.81
Adicional 05 - Obras Cívicas Menores	S/562,775.06	S/476,928.02	S/389,626.67	S/78,252.35	S/9,049.00
Deductivo 04	-S/187,675.96	-S/159,047.42	-S/129,933.90	-S/26,095.83	-S/3,017.69
Adicional 06 - Media Tensión	S/340,246.17	S/288,344.21	S/235,563.00	S/47,310.31	S/5,470.90
Deductivo 05	-S/339,697.56	-S/287,879.29	-S/235,183.18	-S/47,234.03	-S/5,462.08
Contractual - Deduc 1, 2, 3, 4 y 5 + Adic 1, 2, 3, 4, 5 y 6	S/23,011,241.59	S/19,501,052.20	S/15,956,851.00	S/3,173,606.65	S/370,584.55

2) INCIDENCIA DE PRESTACIONES ADICIONALES					
Descripción	PTO TOTAL	Montos (Sin IGV)	Incendencia	Incendencia Acumulada	Montos Parciales (Sin IGV)
Contrato Principal	S/21,509,091.48	S/18,228,043.63	100.00%	100.00%	S/18,228,043.63
Adicional de Obra N°1	S/2,213,942.02	S/1,876,222.05	10.29%	110.29%	
Deductivo Vinculante N°1	-S/1,879,271.36	-S/1,592,602.85	-8.74%	101.56%	S/18,511,662.83
Adicional de Obra N°2	S/160,884.74	S/136,343.00	0.75%	102.30%	S/18,648,005.83
Adicional de Obra N°3	S/676,072.37	S/572,942.69	3.14%	105.45%	
Deductivo Vinculante N°2	-S/242,870.30	-S/205,822.29	-1.13%	104.32%	S/19,015,126.23
Adicional de Obra N°4	S/417,954.90	S/354,199.07	1.94%	106.26%	
Deductivo Vinculante N°3	-S/220,209.97	-S/186,618.62	-1.02%	105.24%	S/19,182,706.68
Adicional de Obra N°5	S/562,775.06	S/476,928.02	2.62%	107.85%	
Deductivo Vinculante N°4	-S/187,675.96	-S/159,047.42	-0.87%	106.98%	S/19,500,587.28
Adicional de Obra N°6	S/340,246.17	S/288,344.21	1.58%	108.56%	
Deductivo Vinculante N°5	-S/339,697.56	-S/287,879.29	-1.58%	106.98%	S/19,501,052.20
Total	S/23,011,241.59	S/19,501,052.20	106.98%		

Control de Fianzas:

4) CONTROL DE CARTAS FIANZA					
Concepto	Monto (Inc. IGV)	Venc.	Entidad	Fianza N°	Observaciones
Fiel cumplimiento (Obra Principal)	S/ 2,150,909.15	1/01/2019	AVLA	3002017003161-2	VENCIDO
Fiel cumplimiento (Adicional de Obra N° 1)	S/ 33,467.07	3/01/2019	BBVA	0011-0178-9800061322-18	VENCIDO
Fiel cumplimiento (Adicional de Obra N° 2)	S/ 16,088.47	31/12/2018	BBVA	0011-0910-9800373012-78	VENCIDO
Fiel cumplimiento (Adicional de Obra N° 3)	S/ 43,320.21				FALTA
Fiel cumplimiento (Adicional de Obra N° 4)	S/ 19,774.49				FALTA
Fiel cumplimiento (Adicional de Obra N° 5)	S/ 37,509.91				FALTA
Fiel cumplimiento (Adicional de Obra N° 6)	S/ 54.86				FALTA
Adelanto Directo	S/ 1,485,539.93	18/11/2018	BANBIF	4410069432.04	VENCIDO
Adelanto de Materiales	S/ 579,982.27	4/12/2018	AVLA	3002017004186-5	VENCIDO
Adelanto de Materiales	S/ 667,500.00	6/12/2018	BANBIF	4410070681.03	VENCIDO
Adelanto de Materiales	S/ 660,000.00	9/12/2018	BCP	D193-01808214	VENCIDO

LUDWIG CARRASCO BUSTAMANTE
 Ing. Supervisor - CIP 79040
 CESEL S.A.

5. ANÁLISIS

A continuación, se muestra la valorización del mes según el siguiente resumen:

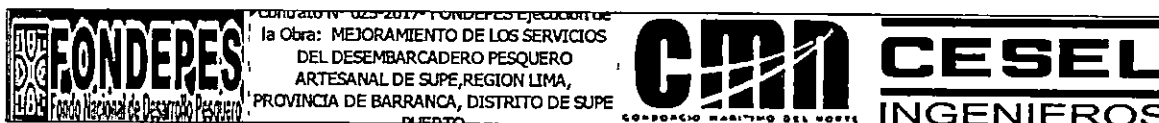

RESUMEN

VALORIZACIÓN N° 18 DEL 01 AL 28 DE FEBRERO DE 2019

OBRA: MEJORAMIENTO DE LOS SERVICIOS DEL DESEMBARCADERO PESQUERO ARTESANAL DE SUPE, REGION LIMA, PROVINCIA DE BARRANCA, DISTRITO DE SUPE PUERTO
 PROP: FONDEPES
 CONTRAT: CONSORCIO MARITIMO DEL NORTE
 SUPERV: CESEL
 sáb 02 Mar 2019

CONCEPTOS	VALORIZACION ACTUAL	VALORIZACION ACUMULADA ANTERIOR	VALORIZACION ACUMULADA ACTUAL
1.1 MONTO VALORIZADO	264,862.51	8,236,299.85	8,501,162.35
1.2 REAJUSTE DE VALORIZACIÓN	20,708.49	206,901.05	227,609.54
A. TOTAL VALORIZACION REAJUSTADA	285,571.00	8,443,200.89	8,728,771.89
2.0 AMORTIZACIONES			
2.1 ADELANTO DIRECTO (12.40%)	32,842.95	885,047.34	917,890.29
2.2 ADELANTO DE MATERIALES	106,641.58	1,768,299.54	1,874,941.12
B. TOTAL AMORTIZACIONES	139,484.53	2,653,346.88	2,792,831.41
3.0 DEDUCCIONES			
3.1 POR EL ADELANTO DIRECTO	1,840.77	16,580.30	18,421.07
3.3 POR EL ADELANTO POR MATERIALES	8,815.80	50,021.64	58,837.43
C. TOTAL DEDUCCIONES	10,656.57	66,601.93	77,258.50
4.0 IGV 18% DE (A-B-C)	24,377.39	1,030,185.38	1,054,562.77
5.0 LIQUIDO A PAGAR AL CONTRATISTA (A-B-C+IGV)	159,807.29	6,753,437.46	6,913,244.75
A FAVOR DEL CONTRATISTA	135,429.90	5,723,252.08	5,858,681.98
POR CONCEPTO DE I.G.V	24,377.39	1,030,185.38	1,054,562.77

LUDWIG BARRASCO BUSTAMANTE
 Ing Supervisor - CIP 79040
 CESEL S.A.

6. AVANCE FINANCIERO MENSUAL DE LA OBRA

Se toma en consideración la valorización revisada por la Supervisión.

Hoja de Cálculo		RESUMEN DE VALORIZACIÓN N°17 DEL 01 AL 28 DE FEBRERO DE 2019		FONDERES CESEL INGENIEROS					
Obra	"Mejoramiento Integral del Desembarcadero Pesquero Artesanal de Supe"					Plazo	225 día		
Contratista	Comercio Marítimo del Norte					Fecha	18 febrero 2019		
Precios	Vía 17 Mar 2017					Supervisor	CESEL S.A.		
						Monto IGV	S/21,928,088.11		
		ACUMULADO MES ANTERIOR		MES ACTUAL		AVANCE ACUMULADO ACTUAL		SALDO	
		Concepto	Monto Acumulado Anterior	% de Avance	Monto Mensual	% de Avance	Monto Acumulado Actual		
A	MONTOS CONTRACTUALES (V.I. - Sin I.G.V.)								
	Presupuesto Obras Particulares	S/8,897,118.00	S/3,275,988.88	36.82%	S/176,769.69	-2.01%	S/3,452,758.57	38.18%	S/5,410,811.44
	Presupuesto Edificación en Tierra - Estructura	S/9,661,409.51	S/2,801,608.08	28.90%	S/17,208.96	0.47%	S/2,818,817.04	28.90%	S/6,842,592.47
	Presupuesto Edificación en Tierra - Arquitectura	S/1,738,221.25	S/476,922.78	27.44%	S/77,103.98	4.44%	S/544,026.76	31.39%	S/1,194,194.49
	Presupuesto Edificación en Tierra - Instalaciones Eléctricas	S/633,003.37	S/32,690.18	5.15%	S/0.00	0.00%	S/32,690.18	5.15%	S/599,313.19
	Presupuesto Edificación en Tierra - Instalaciones Sanitarias	S/820,930.60	S/108,332.75	12.95%	S/8,217.95	-1.00%	S/100,114.80	12.09%	S/712,815.80
	Presupuesto Edificación en Tierra - Equipamiento	S/2,373,454.06	S/1,378,648.90	58.10%	S/0.00	0.00%	S/1,378,648.90	58.10%	S/994,805.16
	Presupuesto Impacto Ambiental	S/53,957.61	S/38,034.52	70.49%	S/0.00	0.00%	S/38,034.52	70.49%	S/15,923.09
	SUB TOTAL PRESUPUESTO	S/18,226,043.83	S/8,119,582.58	44.55%	S/284,882.51	-0.16%	S/8,404,417.41	46.13%	S/9,821,626.42
	IGV	S/3,281,047.85	S/1,458,901.26	44.49%	S/47,675.25	1.45%	S/1,506,576.51	46.81%	S/1,745,159.82
	PRESUPUESTO TOTAL con IGV	S/21,507,091.68	S/9,578,483.84	44.49%	S/332,557.76	1.45%	S/9,910,993.92	46.81%	S/11,466,786.24

En el presente mes el contratista no valorizó trabajos en el adicional 06 de media tensión a pesar de estar programado y habiéndole otorgado la última ampliación de plazo por la ejecución de dicho adicional.

7. SITUACIÓN DE LA OBRA

El Contratista requiere de un Asistente de Oficina Técnica para elaboración de valorizaciones mensuales y control de obra.

El Contratista viene ejecutando pilotes, cerco perimétrico, tarrajes de cercos, cisterna de agua fría, instalaciones eléctricas y sanitarias puntuales.

Falta andamios para pintado.

Falta cerámicos para enchapes.

Falta tableros eléctricos.

Falta puertas y ventanas.

Falta pisos de concreto, canaletas.

En la presente valorización de obra, se está tomando en cuenta el presupuesto de obra ofertado por el contratista con precios base a marzo 2017 y el cronograma de avance de obra valorizado (CAOV) actualizado a la ampliación de plazo N° 14 que culmina el 15 de marzo del 2019.

En la elaboración de la curva S, se tuvo en cuenta los costos directos del presupuesto contractual + adicional 1 + adicional 2 + adicional 3 + adicional 4 + adicional 5 + adicional 6 – deductivo 1 – deductivo 2 – deductivo 3 – deductivo 4 – deductivo 5 y la comparación de avance de obra real vs avance programado en costo directo.

El porcentaje de avance real a Febrero del 2019 es de 1.70% por lo que se tiene un avance real acumulado de 53.04% con respecto al costo directo del monto contratado. El avance programado acumulado a la misma fecha es de 99.34% por lo que se deduce lo siguiente:

- La obra se encuentra atrasada en 46.30%
- El porcentaje de avance real respecto al avance programado es de 53.40%

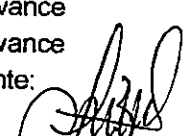
LUDWIG CARRASCO BUSTAMANTE
 Ing. Supervisor - CIP 79040
 CESEL S.A.

Según el artículo 173° del reglamento de contrataciones el estado, el contratista está obligado a cumplir los avances parciales establecidos en el calendario de avance de obra vigente, y en el caso de **retraso injustificado**, cuando el monto de una valorización a una fecha determinada sea menor al ochenta por ciento (80%) del monto de la valorización acumulada programada a dicha fecha se le ordenará al contratista que presente un calendario que contemple la aceleración de trabajos de modo que garantice el cumplimiento de la obra dentro del plazo previsto, anotando tal hecho en el cuaderno de obra.

La supervisión considera que existe causal que justifican el atraso tales como son:

- Falta del permiso de uso de área acuática por parte de DICAPI, que viene siendo gestionado por la Entidad, lo cual imposibilitan la ejecución de las partidas en obra portuaria (Hincado de pilotes, instalación de vigas y losas, lanzamiento de emisor submarino y demolición de muelle existente).
- El contratista no ejecuta el tanque elevado y cisternas.
- Falta de aprobación de adicionales de cerco perimétrico, patio de maniobras, adecuación a la norma sanitaria.

8. CONCLUSIONES

- ✓ El porcentaje de avance real a febrero del 2019 es de 1.70% por lo que se tiene un avance real acumulado de 53.04% con respecto al costo directo del monto contratado. El avance programado acumulado a la misma fecha es de 99.34% por lo que se deduce lo siguiente:
- ✓ La obra se encuentra atrasada. El porcentaje de avance real respecto al cronograma es de 53.40%.
- ✓ El monto líquido, por concepto de valorización de obra N° 18 de Febrero 2019, asciende a **S/. 159,807.29 inc I.G.V.**
- ✓ Se adjunta la valorización presentada por el Contratista (Anexo 02).

9. RECOMENDACIONES.

Se recomienda Fondo Nacional de Desarrollo Pesquero (FONDEPES):

- Pagar la factura del Contratista con el monto de: **S/. 159,807.29** (Ciento cincuenta y nueve mil ocho cientos siete con 29/100 soles) incluido I.G.V.
- Antes de pagar la valorización, el Contratista deberá entregar a la Entidad los siguientes documentos vigentes:
 - o Carta Fianza de Fiel Cumplimiento Vigente
 - o Carta Fianza de Fiel Cumplimiento del Adicional 01.
 - o Carta Fianza de Fiel Cumplimiento del Adicional 02.
 - o Carta Fianza de Fiel Cumplimiento del Adicional 03.
 - o Carta Fianza de Fiel Cumplimiento del Adicional 04.
 - o Carta Fianza de Fiel Cumplimiento del Adicional 05.
 - o Carta Fianza de Fiel Cumplimiento del Adicional 06.
 - o Actualizar Carta Fianza de Adelanto Directo.

.....
LUDWING CARRASCO BUSTAMANTE
Ing. Supervisor - CIP 78040
CESEL S.A.



- o Carta Fianza de Fiel Cumplimiento del Adicional 06.
- o Actualizar Carta Fianza de Adelanto Directo.
- o Actualizar Carta Fianza de Adelanto de Materiales 1.
- o Actualizar Carta Fianza de Adelanto de Materiales 2.
- o Actualizar Carta Fianza de Adelanto de Materiales 3.
- o Seguros de Ley de los adicionales 01, 02, 03, 04, 05 y 06
 - Seguro por accidentes personales.
 - Seguro por equipo pesado y equipo liviano.
 - Seguro riesgo ingeniería – CAR.
 - Seguro responsabilidad frente a terceros.
 - Seguro CAR (Sismo, Tsunamis, etc)

Resumen de Valorización N°18 FEBRERO 2019 Elaborada por la Supervisión

.....
LUDWIG ZARRASCO BUSTAMANTE
Ing. Supervisor - CIP 79040
CESEL S.A.



SERVICIO DE SUPERVISIÓN DE LA OBRA:
"MEJORAMIENTO Y RECUPERACIÓN DE LOS SERVICIOS DEL DESEMBARCADERO PESQUERO ARTESANAL DE SUPE, DISTRITO DE SUPE PUERTO, PROVINCIA DE BARRANCA, REGIÓN LIMA"

000086

		Hoja de Cálculo					 	
RESUMEN DE VALORIZACIÓN N° 17 DEL 01 AL 28 DE FEBRERO DE 2019								
Obra	"Mejoramiento Integral del Desembarcadero Pesquero Artesanal de Supe"					Plan	200 años	
Cuadrante	Consejo Municipal del Norte					Fin	19 febrero 2019	
Proyecto	Vía 17 Mar 2017					Supervisión	13 de Julio 2018	
						Elaborado	17 FEB. 2019	
						Revisado	20 FEBRERO 2019	
A	MONEDAS CONTRACTUALES (V) - En I.G.V.	CONTRATO	ACUMULADO ANTERIOR	MONTO MENSUAL	ACUMULADO ACTUAL	% DE AVANCE	SALDO	
	Presupuesto Expediente Técnico (En I.G.V.)	018,228,843.62	018,228,843.62	018,228,843.62	018,228,843.62		018,228,843.62	
	Presupuesto Obras Portuarias	84,817,189.00	84,817,189.00	84,817,189.00	84,817,189.00		84,817,189.00	
	Presupuesto Edificación en Tierra - Estructura	64,691,408.51	64,691,408.51	64,691,408.51	64,691,408.51		64,691,408.51	
	Presupuesto Edificación en Tierra - Arquitectura	51,738,221.32	51,738,221.32	51,738,221.32	51,738,221.32		51,738,221.32	
	Presupuesto Edificación en Tierra - Instalaciones Eléctricas	5653,003.67	5653,003.67	5653,003.67	5653,003.67		5653,003.67	
	Presupuesto Edificación en Tierra - Instalaciones Sanitarias	5820,830.60	5820,830.60	5820,830.60	5820,830.60		5820,830.60	
	Presupuesto Edificación en Tierra - Equipamiento	32,373,848.24	32,373,848.24	32,373,848.24	32,373,848.24		32,373,848.24	
	Presupuesto Impacto Ambiental	523,057.81	523,057.81	523,057.81	523,057.81		523,057.81	
	EN B TOTAL PRESUPUESTO	318,228,843.62	318,228,843.62	318,228,843.62	318,228,843.62		318,228,843.62	
	I.G.V.	573,281,047.85	573,281,047.85	573,281,047.85	573,281,047.85		573,281,047.85	
	PRESUPUESTO TOTAL Con I.G.V.	891,509,891.47	891,509,891.47	891,509,891.47	891,509,891.47	48.84%	891,509,891.47	
B	REAJUSTES Y REGULARIZACIÓN REAJUSTES (B) - En I.G.V.							
	Reajuste Fórmula Polinómica Val. 17 - Índice Diciembre 2018 Obras Portuarias		589,649.99	589,649.99	589,649.99		589,649.99	
	Reajuste Fórmula Polinómica Val. 17 - Índice Diciembre 2018 Estructuras		578,151.75	578,151.75	578,151.75		578,151.75	
	Reajuste Fórmula Polinómica Val. 17 - Índice Diciembre 2018 Arquitectura		324,700.71	324,700.71	324,700.71		324,700.71	
	Reajuste Fórmula Polinómica Val. 17 - Índice Diciembre 2018 Eléctricas		525,704.03	525,704.03	525,704.03		525,704.03	
	Reajuste Fórmula Polinómica Val. 17 - Índice Diciembre 2018 Sanitarias		519,906.99	519,906.99	519,906.99		519,906.99	
	Reajuste Fórmula Polinómica Val. 17 - Índice Diciembre 2018 Equipamiento		512,173.85	512,173.85	512,173.85		512,173.85	
	Reajuste Fórmula Polinómica Val. 17 - Índice Diciembre 2018 Impacto Ambiental		5442.34	5442.34	5442.34		5442.34	
	TOTAL REAJUSTES		3,208,901.85	3,208,901.85	3,208,901.85		3,208,901.85	
C	VALORIZACION BRUTA (VB = V+B)		321,437,745.47	321,437,745.47	321,437,745.47		321,437,745.47	
D	DEDUCCIONES (D) - En I.G.V.							
	Deducciones del Adelanto Directo							
	Deducciones del Adelanto Directo Obras Portuarias		2177.42	2177.42	2177.42		2177.42	
	Deducciones del Adelanto Directo Edf. en Tierra Estructuras		6447.30	6447.30	6447.30		6447.30	
	Deducciones del Adelanto Directo Edf. en Tierra Arquitectura		399.47	399.47	399.47		399.47	
	Deducciones del Adelanto Directo Edf. en Tierra Instalaciones Eléctricas		242.67	242.67	242.67		242.67	
	Deducciones del Adelanto Directo Edf. en Tierra Instalaciones Sanitarias		2126.29	2126.29	2126.29		2126.29	
	Deducciones del Adelanto Directo Edf. en Tierra Equipamiento		4101.79	4101.79	4101.79		4101.79	
	Deducciones del Adelanto Directo Impacto Ambiental		1.04	1.04	1.04		1.04	
	Deducciones del Adelanto de Materiales							
	Deducciones del Adelanto de materiales Obras Portuarias		570,159.45	570,159.45	570,159.45		570,159.45	
	Deducciones del Adelanto de materiales Edf. en Tierra Estructuras		527,167.88	527,167.88	527,167.88		527,167.88	
	Deducciones del Adelanto de materiales Edf. en Tierra Arquitectura		572,694.31	572,694.31	572,694.31		572,694.31	
	Deducciones del Adelanto de materiales Edf. en Tierra Instalaciones Eléctricas		0.00	0.00	0.00		0.00	
	Deducciones del Adelanto de materiales Edf. en Tierra Instalaciones Sanitarias		0.00	0.00	0.00		0.00	
	Deducciones del Adelanto de materiales Edf. en Tierra Equipamiento		0.00	0.00	0.00		0.00	
	Deducciones del Adelanto de materiales Impacto Ambiental		0.00	0.00	0.00		0.00	
	TOTAL DEDUCCIONES		64,804.63	64,804.63	64,804.63		64,804.63	
E	AMORTIZACIONES (A)							
	Amortización de Adelanto Directo (13.40%)		4,322,894.37	4,322,894.37	4,322,894.37		4,322,894.37	
	Amortización del Adelanto Directo Obras Portuarias		894,928.56	894,928.56	894,928.56		894,928.56	
	Amortización del Adelanto Directo Edf. en Tierra Estructuras		869,711.81	869,711.81	869,711.81		869,711.81	
	Amortización del Adelanto Directo Edf. en Tierra Arquitectura		368,140.85	368,140.85	368,140.85		368,140.85	
	Amortización del Adelanto Directo Edf. en Tierra Instalaciones Eléctricas		173,822.12	173,822.12	173,822.12		173,822.12	
	Amortización del Adelanto Directo Edf. en Tierra Instalaciones Sanitarias		95,300.36	95,300.36	95,300.36		95,300.36	
	Amortización del Adelanto Directo Edf. en Tierra Equipamiento		82,093.08	82,093.08	82,093.08		82,093.08	
	Amortización del Adelanto Directo Impacto Ambiental		237,240.41	237,240.41	237,240.41		237,240.41	
	Amortización del Adelanto de Materiales		5,368.78	5,368.78	5,368.78		5,368.78	
	Amortización de Adelanto de materiales		1,000,000.00	1,784,298.24	1,784,298.24		1,784,298.24	
	Amortización del Adelanto de Materiales Obras Portuarias N°01			784,067.87	784,067.87		784,067.87	
	Amortización del Adelanto de Materiales Obras Portuarias N°02		26889.25	26889.25	26889.25		26889.25	
	Amortización del Adelanto de Materiales Obras Portuarias N°03		208796.47	208796.47	208796.47		208796.47	
	Amortización del Adelanto de Materiales Edf. en Tierra Estructuras N°01		128915.18	128915.18	128915.18		128915.18	
	Amortización del Adelanto de Materiales Edf. en Tierra Estructuras N°02		344390.06	344390.06	344390.06		344390.06	
	Amortización del Adelanto de Materiales Edf. en Tierra Arquitectura N°03		20889.64	20889.64	20889.64		20889.64	
	Amortización del Adelanto de Materiales Edf. en Tierra Arquitectura N°01			0.00	0.00		0.00	
	Amortización del Adelanto de Materiales Edf. en Tierra Arquitectura N°02		33722.15	33722.15	33722.15		33722.15	
	Amortización del Adelanto de Materiales Edf. en Tierra Instalaciones Eléctricas		0.00	0.00	0.00		0.00	
	Amortización del Adelanto de Materiales Edf. en Tierra Instalaciones Sanitarias		0.00	0.00	0.00		0.00	
	Amortización del Adelanto de Materiales Edf. en Tierra Equipamiento		0.00	0.00	0.00		0.00	
	Amortización del Adelanto de Materiales Impacto Ambiental		0.00	0.00	0.00		0.00	
	TOTAL AMORTIZACIONES		2,463,278.05	2,463,278.05	2,463,278.05		2,463,278.05	
F	VALORIZACION NETA (VN = VB-D-A)		256,633,070.84	256,633,070.84	256,633,070.84		256,633,070.84	
G	MONEDAS A PAGAR AL CONTRATISTA							
	En Efectivo (VN)		5,723,370.82	5,723,370.82	5,723,370.82		5,723,370.82	
	I.G.V. (VN x 18%)		1,030,200.77	1,030,200.77	1,030,200.77		1,030,200.77	
H	MONTO TOTAL DE LA VALORIZACION CON I.G.V. EN NUEVOS SOLES		6,753,571.59	6,753,571.59	6,753,571.59		6,753,571.59	
I	CALENDARIO DE COMPROMISO A SOLICITAR EN NUEVOS SOLES			159,807.29	159,807.29		159,807.29	

LUDWIN CARRASCO BUSTAMANTE
 Ing. Supervisor - CIP 79040
CESEL S.A.

SERVICIO DE SUPERVISIÓN DE LA OBRA:
"MEJORAMIENTO Y RECUPERACIÓN DE LOS SERVICIOS DEL DESEMBARCADERO PESQUERO ARTESANAL DE SUPE, DISTRITO DE SUPE PUERTO, PROVINCIA DE BARRANCA, REGIÓN LIMA"

 			
RESUMEN VALORIZACIÓN N° 18 DEL 01 AL 28 DE FEBRERO DE 2019			
OBRA:	MEJORAMIENTO DE LOS SERVICIOS DEL DESEMBARCADERO PESQUERO ARTESANAL DE SUPE, REGIÓN LIMA, PROVINCIA DE BARRANCA, DISTRITO DE SUPE PUERTO		
PROY:	FONDERES		
CONTRATISTA:	CONSORCIO MANTENIMIENTO DEL NOROCCIDENTE		
SUPLENTE:	CESEL		
CONCEPTO	VALORIZACION ACTUAL	VALORIZACION ACUMULADA ANTERIOR	VALORIZACION ACUMULADA ACTUAL
1.1 MONTO VAL. OBRAS PORTUARIAS	178,769.65	3,275,596.89	3,454,366.54
1.2 REALISTE DE VAL. OBRAS PORTUARIAS	15,253.00	88,549.96	103,802.96
2.1 MONTO VAL. EDIFICIO EN TIERRA ESTRUCTURA	17,206.86	2,834,424.52	2,851,631.39
2.2 REALISTE DE VAL. EDIFICIO EN TIERRA ESTRUCTURA	1,130.48	76,151.75	77,282.22
3.1 MONTO VAL. EDIFICIO EN TIERRA ARQUITECTURA	77,103.98	566,042.55	643,146.53
3.2 REALISTE DE VAL. EDIFICIO EN TIERRA ARQUITECTURA	3,788.58	36,750.71	40,539.29
4.1 MONTO VAL. EDIF. EN TIERRA INSTALACIONES ELECTRICAS	-	35,414.48	35,414.48
4.2 REALISTE DE VAL. EDIF. EN TIERRA INSTALACIONES ELECTRICAS	-	-25,784.03	-25,784.03
5.1 MONTO VAL. EDIF. EN TIERRA INSTALACIONES SANITARIAS	-8,217.99	107,418.46	99,200.47
5.2 REALISTE DE VAL. EDIF. EN TIERRA INSTALACIONES SANITARIAS	-2,463.55	18,605.66	17,142.11
6.1 MONTO VAL. EDIFICIO EN TIERRA EQUIPAMIENTO	-	1,378,948.60	1,378,948.60
6.2 REALISTE DE VAL. EDIFICIO EN TIERRA EQUIPAMIENTO	-	12,171.65	12,171.65
7.1 MONTO VAL. IMPACTO AMBIENTAL	-	38,064.34	38,064.34
7.2 REALISTE DE VAL. IMPACTO AMBIENTAL	-	442.34	442.34
A. TOTAL VALORIZACION REAJUSTADA	285,571.00	5,443,200.89	6,728,771.89
2.0 AMBITIZACIONES	-	-	-
2.0 OBRAS PORTUARIAS	-	-	-
2.1 ADELANTO DIRECTO	22,167.44	337,906.03	359,973.45
2.2 ADELANTO DE MATERIALES N°01	-	764,067.67	764,067.67
2.3 ADELANTO DE MATERIALES N°02	94,732.83	268,988.35	363,721.17
2.4 ADELANTO DE MATERIALES N°03	-	-	-
2.1 EDIFICIO EN TIERRA ESTRUCTURA	-	-	-
2.1 ADELANTO DIRECTO	2,133.63	305,630.78	307,764.41
2.2 ADELANTO DE MATERIALES N°01	-	208,786.47	208,786.47
2.3 ADELANTO DE MATERIALES N°02	6,447.58	47,845.27	54,292.85
2.4 ADELANTO DE MATERIALES N°03	-	20,889.64	20,889.64
2.1 EDIFICIO EN TIERRA ARQUITECTURA	-	-	-
2.1 ADELANTO DIRECTO	9,560.89	65,783.00	75,343.89
2.2 ADELANTO DE MATERIALES N°01	-	-	-
2.3 ADELANTO DE MATERIALES N°02	5,281.74	33,722.15	39,003.89
2.4 ADELANTO DE MATERIALES N°03	-	-	-
2.1 EDIF. EN TIERRA INSTALACIONES ELECTRICAS	-	-	-
2.1 ADELANTO DIRECTO	-	6,117.75	6,117.75
2.2 ADELANTO DE MATERIALES	-	-	-
2.1 EDIF. EN TIERRA INSTALACIONES SANITARIAS	-	-	-
2.1 ADELANTO DIRECTO	-1,019.03	12,715.50	11,696.47
2.2 ADELANTO DE MATERIALES	-	-	-
2.1 EDIFICIO EN TIERRA EQUIPAMIENTO	-	-	-
2.1 ADELANTO DIRECTO	-	154,993.82	154,993.82
2.2 ADELANTO DE MATERIALES	-	-	-
2.1 IMPACTO AMBIENTAL	-	-	-
2.1 ADELANTO DIRECTO	-	4,000.49	4,000.49
2.2 ADELANTO DE MATERIALES	-	-	-
B. TOTAL AMBITIZACIONES	139,484.53	2,653,346.82	2,792,831.61
3.0 DEDUCCIONES	-	-	-
3.0 OBRAS PORTUARIAS	-	-	-
3.1 POR EL ADELANTO DIRECTO	1,555.42	2,177.42	3,732.84
3.3 POR EL ADELANTO POR MATERIALES	7,718.72	10,159.45	17,878.15
2.1 EDIFICIO EN TIERRA ESTRUCTURA	-	-	-
3.1 POR EL ADELANTO DIRECTO	107.30	5,447.30	5,554.60
3.3 POR EL ADELANTO POR MATERIALES	577.63	37,167.88	37,745.51
2.1 EDIFICIO EN TIERRA ARQUITECTURA	-	-	-
3.1 POR EL ADELANTO DIRECTO	522.92	2,969.42	3,492.34
3.3 POR EL ADELANTO POR MATERIALES	569.46	2,694.91	3,264.37
2.1 EDIF. EN TIERRA INSTALACIONES ELECTRICAS	-	-	-
3.1 POR EL ADELANTO DIRECTO	-	-242.97	-242.97
3.3 POR EL ADELANTO POR MATERIALES	-	-	-
2.1 EDIF. EN TIERRA INSTALACIONES SANITARIAS	-	-	-
3.1 POR EL ADELANTO DIRECTO	-174.87	2,126.29	1,951.42
3.3 POR EL ADELANTO POR MATERIALES	-	-	-
2.1 EDIFICIO EN TIERRA EQUIPAMIENTO	-	-	-
3.1 POR EL ADELANTO DIRECTO	-	4,101.79	4,101.79
3.3 POR EL ADELANTO POR MATERIALES	-	-	-
2.1 IMPACTO AMBIENTAL	-	-	-
3.1 POR EL ADELANTO DIRECTO	-	1.04	1.04
3.3 POR EL ADELANTO POR MATERIALES	-	-	-
C. TOTAL DEDUCCIONES	10,656.57	86,601.93	77,258.50
4.0 IGV 18% DE (A-B-C)	24,377.39	1,030,185.98	1,054,563.77
5.0 LIQUIDO A PAGAR AL CONTRATISTA (A-B-C+D)	159,877.29	6,753,487.46	8,113,244.25
A FAVOR DEL CONTRATISTA	135,429.90	5,773,252.08	5,808,681.98
POR CONCEPTO DE I.G.V.	24,377.39	1,030,185.98	1,054,563.77

LUDWING CARRASCO BUSTAMANTE
 Ing. Supervisor - CIP 79040
CESEL S.A.

ANEXO 01
Valorización N°18 – FEBRERO 2019
Elaborada por la Supervisión

LUDWING CASARASO BUSTAMANTE
Ing. Supervisor - CIP 79040
CESEL S.A.



Hoja de Cálculo

RESUMEN DE VALORIZACIÓN N° 17 DEL 01 AL 28 DE FEBRERO DE 2019



Obra	"Mejoramiento Integral del Desembarcadero Pequeño Artesanal de Supe"	Plazo	270 días
Contratista	Consortio Marino del Norte	Inicio	15 de febrero 2017
Pruebas	16/17 Mar 2017	Fin	15 de junio 2018
		Supervisión	CESEL S.A
		Monto Inv. ICV	\$21,509,089.61

	CONTRATO	ACUMULADO ANTERIOR	MONTO MENSUAL	ACUMULADO ACTUAL	% DE AVANCE	SALDO
A	MONTO CONTRACTUALES (V) - Sin I.G.V.					
	Presupuesto Expediente Técnico (Sin I.G.V.)	S/18,228,043.63	S/8,238,289.85	S/264,882.51	S/8,501,162.33	S/8,726,691.28
	Presupuesto Obras Portuarias	S/8,897,118.06	S/3,275,986.89	S/178,769.68	3,454,756.55	S/5,442,361.51
	Presupuesto Edificación en Tierra - Estructura	S/8,061,403.51	S/2,834,424.52	S/17,206.88	2,851,631.39	S/839,777.12
	Presupuesto Edificación en Tierra - Arquitectura	S/1,738,221.23	S/566,042.55	S/77,103.98	643,146.53	S/1,095,074.70
	Presupuesto Edificación en Tierra - Instalaciones Eléctricas	S/653,003.57	S/35,414.48	S/0.00	35,414.48	S/617,589.09
	Presupuesto Edificación en Tierra - Instalaciones Sanitarias	S/620,930.60	S/107,418.46	-S/8,217.99	99,200.47	S/721,730.13
	Presupuesto Edificación en Tierra - Equipamiento	S/2,373,404.09	1378948.60	S/0.00	1,378,948.60	58.1%
	Presupuesto Impacto Ambiental	S/53,987.61	S/38,064.34	S/0.00	38,064.34	70.5%
	SUB TOTAL PRESUPUESTO	S/18,228,043.63	S/8,238,289.85	S/264,882.51	S/8,501,162.33	S/8,726,691.28
	I.G.V.	S/8,281,047.85	S/1,482,833.97	S/47,675.25	S/1,830,209.22	S/1,750,836.63
	PRESUPUESTO TOTAL Con I.G.V.	S/21,509,091.48	S/9,718,833.82	S/312,557.75	S/10,331,371.58	46.64%
B	REAJUSTES Y REGULARIZACION REAJUSTES (S) - Sin I.G.V.					
	Reajuste Fórmula Polinómica Val. 17 - Indices Diciembre 2018 Obras Portuarias		S/88,549.98	S/15,253.00	S/103,602.96	
	Reajuste Fórmula Polinómica Val. 17 - Indices Diciembre 2018 Estructuras		S/76,151.75	S/1,130.48	S/77,282.22	
	Reajuste Fórmula Polinómica Val. 17 - Indices Diciembre 2018 Arquitectura		S/36,760.71	S/6,788.58	S/42,549.29	
	Reajuste Fórmula Polinómica Val. 17 - Indices Diciembre 2018 Eléctricas		-S/25,784.03	S/0.00	-S/25,784.03	
	Reajuste Fórmula Polinómica Val. 17 - Indices Diciembre 2018 Sanitarias		S/18,606.66	-S/1,463.55	S/17,143.11	
	Reajuste Fórmula Polinómica Val. 17 - Indices Diciembre 2018 Equipamiento		S/21,173.65	S/0.00	S/21,173.65	
	Reajuste Fórmula Polinómica Val. 17 - Indices Diciembre 2018 Impacto Ambiental		S/442.34	S/0.00	S/442.34	
	TOTAL REAJUSTES		S/206,901.05	S/20,708.49	S/227,609.54	
C	VALORIZACION BRUTA (VB = V+S)					
		S/8,443,200.89	S/285,571.00	S/8,728,771.89		
D	DEDUCCIONES (D) - Sin I.G.V.					
	Deducciones del Adelanto Directo					
	Deducciones del Adelanto Directo Obras Portuarias		2177.42	1385.42	3562.84	
	Deducciones del Adelanto Directo Edif. en Tierra Estructuras		5447.30	107.30	5554.60	
	Deducciones del Adelanto Directo Edif. en Tierra Arquitectura		2869.42	522.92	3392.34	
	Deducciones del Adelanto Directo Edif. en Tierra Instalaciones Eléctricas		-242.97	0.00	-242.97	
	Deducciones del Adelanto Directo Edif. en Tierra Instalaciones Sanitarias		2125.28	-174.87	1950.41	
	Deducciones del Adelanto Directo Edif. en Tierra Equipamiento		4101.79	0.00	4101.79	
	Deducciones del Adelanto Directo Impacto Ambiental		1.04	0.00	1.04	
	Deducciones del Adelanto de Materiales					
	Deducciones del Adelanto de materiales Obras Portuarias		S/10,159.45	S/7,718.72	17878.16	
	Deducciones del Adelanto de materiales Edif. en Tierra Estructuras		S/37,187.88	S/627.63	37815.51	
	Deducciones del Adelanto de materiales Edif. en Tierra Arquitectura		S/2,894.31	S/569.46	3463.76	
	Deducciones del Adelanto de materiales Edif. en Tierra Instalaciones Eléctricas		0.00	0.00	0.00	
	Deducciones del Adelanto de materiales Edif. en Tierra Instalaciones Sanitarias		0.00	0.00	0.00	
	Deducciones del Adelanto de materiales Edif. en Tierra Equipamiento		0.00	0.00	0.00	
	Deducciones del Adelanto de materiales Impacto Ambiental		0.00	0.00	0.00	
	TOTAL DEDUCCIONES		66,601.93	10,656.87	77,258.80	
E	AMORTIZACIONES (A)					
	Amortización de Adelanto Directo (12.40%)	1,822,804.37	884,828.80	32,842.95	817,771.45	
	Amortización del Adelanto Directo Obras Portuarias	889,711.81	S/337,806.01	S/22,167.44	359973.45	
	Amortización del Adelanto Directo Edif. en Tierra Estructuras	369,140.85	S/308,830.78	S/2,133.65	307764.43	
	Amortización del Adelanto Directo Edif. en Tierra Arquitectura	178,822.12	S/65,783.00	S/9,560.69	75343.89	
	Amortización del Adelanto Directo Edif. en Tierra Instalaciones Eléctricas	65,300.36	S/3,988.91	S/0.00	3988.91	
	Amortización del Adelanto Directo Edif. en Tierra Instalaciones Sanitarias	82,093.06	S/12,718.50	-S/1,019.03	11696.47	
	Amortización del Adelanto Directo Edif. en Tierra Equipamiento	237,240.41	S/154,883.82	S/0.00	184993.82	
	Amortización del Adelanto Directo Impacto Ambiental	5,395.76	S/4,000.49	S/0.00	4000.49	
	Amortización de Adelanto de materiales					
	Amortización del Adelanto de Materiales Obras Portuarias N°01	1,000,000.00	1,788,289.54	108,641.58	1,874,941.12	
	Amortización del Adelanto de Materiales Obras Portuarias N°02		764,067.67	0.00	764,067.67	
	Amortización del Adelanto de Materiales Obras Portuarias N°03		288,988.35	94,732.63	383,721.17	
	Amortización del Adelanto de Materiales Edif. en Tierra Estructuras N°01		126,915.18	0.00	126,915.18	
	Amortización del Adelanto de Materiales Edif. en Tierra Estructuras N°02		344,630.09	6,447.98	351,078.07	
	Amortización del Adelanto de Materiales Edif. en Tierra Estructuras N°03		20,889.64	179.93	21,069.58	
	Amortización del Adelanto de Materiales Edif. en Tierra Arquitectura N°01		0.00	0.00	0.00	
	Amortización del Adelanto de Materiales Edif. en Tierra Arquitectura N°02		3372.15	678.14	3903.89	
	Amortización del Adelanto de Materiales Edif. en Tierra Arquitectura N°03		0.00	0.00	0.00	
	Amortización del Adelanto de Materiales Edif. en Tierra Instalaciones Eléctricas		0.00	0.00	0.00	
	Amortización del Adelanto de Materiales Edif. en Tierra Instalaciones Sanitarias		0.00	0.00	0.00	
	Amortización del Adelanto de Materiales Edif. en Tierra Equipamiento		0.00	0.00	0.00	
	Amortización del Adelanto de Materiales Impacto Ambiental		0.00	0.00	0.00	
	TOTAL AMORTIZACIONES	2,653,228.05	139,494.93	2,792,712.98		
F	VALORIZACION NETA (VN = VB-D+A)					
		5,723,370.92	135,429.90	5,858,800.82		
G	MONTO A PAGAR AL CONTRATISTA					
	En Efectivo (VN)	5,723,370.92	135,429.90	5,858,800.82		
	I.G.V. (VN x 18%)	1,030,208.77	24,377.39	1,054,586.16		
H	MONTO TOTAL DE LA VALORIZACION CON I.G.V. EN NUEVOS SOLES					
		6,753,679.69	159,807.29	6,913,386.98		
I	CALENDARIO DE COMPROMISO A SOLICITAR EN NUEVOS SOLES					
			169,807.29			

[Firma]
LUDWIG CARRASCO BUSTAMANTE
 Ing. Supervisor - CIP 79040
 CESEL S.A.



Hoja de Cálculo

RESUMEN DE VALORIZACIÓN N°17 DEL 01 AL 28 DE FEBRERO DE 2019



Obra	"Mejoramiento Integral del Desembarcadero Pesquero Artesanal de Supe"	Plazo	300 días
		Inicio	19 setiembre 2017
		Fin	15 de Julio 2018
Contratista	Consorcio Marítimo del Norte	Supervisión	CESEL S. A.
Precios	vie 17 Mar 2017	Monto IGV	S/21,509,089.61

	Contrato	ACUMULADO MES ANTERIOR		MES ACTUAL		AVANCE ACUMULADO ACTUAL		SALDO
		Monto Acumulado Anterior	% de Avance	Monto Mensual	% de Avance	Monto Acumulado Actual	% de Avance	
A	MONTOS CONTRACTUALES (V) - Sin I.G.V.							
	Presupuesto Obras Portuarias	S/8,897,118.06	36.82%	S/178,769.65	2.01%	S/3,486,306.62	39.18%	S/5,410,811.44
	Presupuesto Edificación en Tierra - Estructura	S/3,691,408.51	75.90%	S/17,206.86	0.47%	S/2,851,631.38	77.25%	S/839,777.13
	Presupuesto Edificación en Tierra - Arquitectura	S/1,738,221.23	27.44%	S/77,103.98	4.44%	S/643,146.52	37.00%	S/1,095,074.71
	Presupuesto Edificación en Tierra - Instalaciones Electricas	S/653,003.57	5.00%	S/0.00	0.00%	S/35,414.48	5.42%	S/617,589.09
	Presupuesto Edificación en Tierra - Instalaciones Sanitarias	S/820,930.60	12.95%	-S/8,217.99	-1.00%	S/99,200.46	12.08%	S/721,730.13
	Presupuesto Edificación en Tierra - Equipamiento	S/2,373,404.06	58.10%	S/0.00	0.00%	S/1,378,948.60	58.10%	S/994,455.45
	Presupuesto Impacto Ambiental	S/53,957.61	70.49%	S/0.00	0.00%	S/38,064.34	70.54%	S/15,893.28
	SUB TOTAL PRESUPUESTO	S/18,228,043.63	S/8,110,562.58	S/264,862.51		S/8,532,712.41		S/9,695,331.23
	I.G.V.	S/3,281,047.85	S/1,459,901.26	S/47,675.25		S/1,535,888.23		S/1,745,159.62
	PRESUPUESTO TOTAL con IGV	S/21,509,091.48	S/9,570,463.84	S/312,537.76	1.45%	S/10,068,600.64	46.81%	S/11,440,490.85



 LUDWING CARRASCO BUSTAMANTE
 Ing. Supervisor - CIP 79040
 CESEL S.A.

000062



Contrato N° 025-2017- FONDEPES Ejecución de la
Obra: MEJORAMIENTO DE LOS SERVICIOS DEL
DESEMBARCADERO PESQUERO ARTESANAL DE
SUPE, REGION LIMA, PROVINCIA DE BARRANCA,
DISTRITO DE SUPE PUERTO



CESEL
INGENIEROS

RESUMEN

VALORIZACIÓN N° 18 DEL 01 AL 28 DE FEBRERO DE 2019

OBRA: MEJORAMIENTO DE LOS SERVICIOS DEL DESEMBARCADERO PESQUERO ARTESANAL DE SUPE ,REGION LIMA, PROVINCIA DE BARRANCA, DISTRITO DE SUPE PUERTO
PROP: FONDEPES
CONTRAT: CONSORCIO MARITIMO DEL NORTE
SUPERV: CESEL
sáb 02 Mar 2019

CONCEPTOS	VALORIZACION ACTUAL	VALORIZACION ACUMULADA ANTERIOR	VALORIZACION ACUMULADA ACTUAL
1.1 MONTO VALORIZADO	264,862.51	8,236,299.85	8,501,162.35
1.2 REAJUSTE DE VALORIZACIÓN	20,708.49	206,901.05	227,609.54
A. TOTAL VALORIZACION REAJUSTADA	285,571.00	8,443,200.89	8,728,771.89
2.0 AMORTIZACIONES			
2.1 ADELANTO DIRECTO (12.40%)	32,842.95	885,047.34	917,890.29
2.2 ADELANTO DE MATERIALES	106,641.58	1,768,299.54	1,874,941.12
B. TOTAL AMORTIZACIONES	139,484.53	2,653,346.88	2,792,831.41
3.0 DEDUCCIONES			
3.1 POR EL ADELANTO DIRECTO	1,840.77	16,580.30	18,421.07
3.3 POR EL ADELANTO POR MATERIALES	8,815.80	50,021.64	58,837.43
C. TOTAL DEDUCCIONES	10,656.57	66,601.93	77,258.50
4.0 IGV 18% DE (A-B-C)	24,377.39	1,030,185.38	1,054,562.77
5.0 LIQUIDO A PAGAR AL CONTRATISTA (A-B-C+IGV)	159,807.29	6,753,437.46	6,913,244.75
A FAVOR DEL CONTRATISTA	135,429.90	5,723,252.08	5,858,681.98
POR CONCEPTO DE I.G.V	24,377.39	1,030,185.38	1,054,562.77

LUDWIG CARRASCO BUSTAMANTE
Ing. Supervisor - CIP 79040
CESEL S.A.

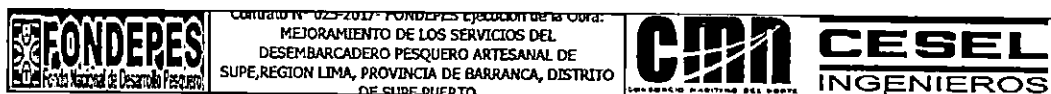

RESUMEN

VALORIZACIÓN N° 18 DEL 01 AL 28 DE FEBRERO DE 2019

OBRA: MEJORAMIENTO DE LOS SERVICIOS DEL DESEMBARCADERO PESQUERO ARTESANAL DE SUPE, REGION LIMA, PROVINCIA DE BARRANCA, DISTRITO DE SUPE
 PROP: FONDEPES
 CONTRAT: CONSORCIO MARITIMO DEL NORTE
 SUPERV: CESEL

CONCEPTOS	VALORIZACION ACTUAL	VALORIZACION ACUMULADA ANTERIOR	VALORIZACION ACUMULADA ACTUAL
B. TOTAL AMORTIZACIONES	139,484.53	2,653,346.88	2,792,831.41
3.0 DEDUCCIONES			
2.0 OBRAS PORTUARIAS			
3.1 POR EL ADELANTO DIRECTO	1,385.42	2,177.42	3,562.84
3.3 POR EL ADELANTO POR MATERIALES	7,718.72	10,159.45	17,878.16
2 EDIFICIO EN TIERRA ESTRUCTURA			
3.1 POR EL ADELANTO DIRECTO	107.30	5,447.30	5,554.60
3.3 POR EL ADELANTO POR MATERIALES	527.63	37,167.88	37,695.51
2 EDIFICIO EN TIERRA ARQUITECTURA			
3.1 POR EL ADELANTO DIRECTO	522.92	2,969.42	3,492.34
3.3 POR EL ADELANTO POR MATERIALES	569.46	2,694.31	3,263.76
2 EDIF. EN TIERRA INSTALACIONES ELECTRICAS			
3.1 POR EL ADELANTO DIRECTO	-	-242.97	-242.97
3.3 POR EL ADELANTO POR MATERIALES	-	-	-
2 EDIF. EN TIERRA INSTALACIONES SANITARIAS			
3.1 POR EL ADELANTO DIRECTO	-174.87	2,126.29	1,951.42
3.3 POR EL ADELANTO POR MATERIALES	-	-	-
2 EDIFICIO EN TIERRA EQUIPAMIENTO			
3.1 POR EL ADELANTO DIRECTO	-	4,101.79	4,101.79
3.3 POR EL ADELANTO POR MATERIALES	-	-	-
2 IMPACTO AMBIENTAL			
3.1 POR EL ADELANTO DIRECTO	-	1.04	1.04
3.3 POR EL ADELANTO POR MATERIALES	-	-	-
C. TOTAL DEDUCCIONES	10,656.57	66,601.93	77,258.50
4.0 IGV 18% DE (A-B-C)	24,377.39	1,030,185.38	1,054,562.77
5.0 LIQUIDO A PAGAR AL CONTRATISTA (A-B-CHGV)	<u>159,807.29</u>	6,753,437.46	6,913,244.75
A FAVOR DEL CONTRATISTA	135,429.90	5,723,252.08	5,858,681.98
POR CONCEPTO DE I.G.V	24,377.39	1,030,185.38	1,054,562.77

 LUCWING CARRASCO BUSTAMANTE
 Ing. Supervisor - CIP 79040
 CESEL S.A.



VALORIZACIÓN N° 18 DEL 01 AL 28 DE FEBRERO DEL 2019 (PRECIOS UNITARIOS)

Contrato N° 025-2017- FONDEPES Ejecución de la Obra: MEJORAMIENTO DE LOS SERVICIOS DEL DESEMBARCADERO PESQUERO ARTESANAL DE SUPE, REGION LIMA, PROVINCIA DE BARRANCA, DISTRITO DE SUPE PUERTO



OBRA: MEJORAMIENTO DE LOS SERVICIOS DEL DESEMBARCADERO PESQUERO ARTESANAL DE SUPE ,REGION LIMA, PROVINCIA DE BARRANCA, DISTRITO DE SUPE PUERTO
 SUB PRES OBRAS PORTUARIAS
 PROP. FONDEPES
 CONT. CONSORCIO MARITIMO DEL NORTE
 SUP. CESEL

FECHA: sáb 02 Mar 2019

ITEM	DESCRIPCION	PRESUPUESTO			VAL. ACUM. ANTERIOR			VAL ACTUAL			VAL. ACUM. ACTUAL			SALDOS			
		Und.	Metrado	Precio (S./.)	Parcial (S./.)	Metrado	Parcial (S./.)	%	Metrado	Parcial (S./.)	%	Metrado	Parcial (S./.)	%	Metrado	Parcial (S./.)	%
01	OBRAS PORTUARIAS																
01.01	OBRAS PROVISIONALES																
01.01.01	MOVILIZACION Y DESMOVILIZACION DE EQUIPOS	1.00		42,963.69	42,963.69	1.00	S/42,963.69	100.00%	0.00	0.00	0.00%	1.00	42,963.69	100.00%	0.0000	0.00	0.00%
01.01.02	FLETE TERRESTRE DE MATERIALES	3,056.63		85.92	262,625.65	3,056.63	S/262,625.65	100.00%	0.00	0.00	0.00%	3,056.63	262,625.65	100.00%	0.0000	0.00	0.00%
01.01.03	TRAZO Y REPLANTEO DE OBRA	9.00		2,287.15	20,584.35	9.00	S/20,584.35	100.00%	0.00	0.00	0.00%	9.00	20,584.35	100.00%	0.0000	0.00	0.00%
01.01.04	AGUA PARA OBRA	9.00		297.14	2,674.26	9.00	S/2,674.26	100.00%	0.00	0.00	0.00%	9.00	2,674.26	100.00%	0.0000	0.00	0.00%
01.01.05	ENERGIA PARA OBRA	9.00		1,452.65	13,073.85	9.00	S/13,073.85	100.00%	0.00	0.00	0.00%	9.00	13,073.85	100.00%	0.0000	0.00	0.00%
01.01.06	CARTEL DE OBRA	2.00		2,767.23	5,534.46	2.00	S/5,534.46	100.00%	0.00	0.00	0.00%	2.00	5,534.46	100.00%	0.0000	0.00	0.00%
01.01.07	LOSAS PARA PREFABRICADOS (Concreto f'c=210 kg/cm2)	240.00		141.92	34,060.80	240.00	S/34,060.80	100.00%	0.00	0.00	0.00%	240.00	34,060.80	100.00%	0.0000	0.00	0.00%
01.01.08	LIMPIEZA FINAL DE OBRA	1.00		3,448.35	3,448.35	1.00	S/0.00	0.00%	0.00	0.00	0.00%	1.00	3,448.35	100.00%	0.0000	0.00	0.00%
01.01.09	CASETA PARA CONTRATISTA Y SUPERVISIÓN	120.00		182.41	21,889.20	120.00	S/21,889.20	100.00%	0.00	0.00	0.00%	120.00	21,889.20	100.00%	0.0000	0.00	0.00%
01.01.10	PRUEBA DE CARGA	4.00		16,884.27	67,537.08	1.00	S/16,884.27	25.00%	0.00	0.00	0.00%	1.00	16,884.27	25.00%	3.0000	50,652.81	75.00%
01.01.11	DEMOLICIÓN DE LOSAS Y VIGAS (PUENTE Y CABEZO)	291.45		381.67	111,237.72	18.47	S/7,049.44	6.34%	0.00	0.00	0.00%	18.47	7,049.44	6.34%	272.9800	104,188.28	93.66%
01.01.12	ALMACEN DE OBRA	120.00		182.41	21,889.20	120.00	S/21,889.20	100.00%	0.00	0.00	0.00%	120.00	21,889.20	100.00%	0.0000	0.00	0.00%
01.01.13	EQUIPOS E IMPLEMENTOS DE SEGURIDAD	3.00		17,918.25	53,754.75	2.00	S/35,836.50	66.67%	0.00	0.00	0.00%	2.00	35,836.50	66.67%	1.0000	17,918.25	33.33%
01.02	MUELLE TIPO ESPIGÓN																
01.02.01	FABRICACIÓN DE PILOTOS DE CONCRETO																
01.02.01.01	CONCRETO EN PILOTOS f'c=350 kg/cm2	576.32		552.49	318,411.04	400.37	S/221,200.42	69.47%	45.87	25,340.51	7.96%	446.24	246,540.93	77.43%	130.08	71,870.11	22.57%
01.02.01.02	ENCOFRADO Y DESENCOFRADO	4,610.52		44.69	206,044.14	2,508.70	S/112,113.80	54.41%	130.15	5,816.22	2.82%	2,638.85	117,930.03	57.24%	1,971.67	88,114.11	42.76%
01.02.01.03	ACERO CORRUGADO FY= 4200 kg/cm2	181,053.38		4.20	760,424.20	149,289.07	S/627,014.09	82.46%	18,463.87	77,548.25	10.20%	167,752.94	704,562.35	92.65%	13,300.44	55,861.85	7.35%
01.02.02	FABRICACIÓN DE VIGAS TRANSVERSALES																
01.02.02.01	CONCRETO VIGAS TRANSVERSALES f'c=280 kg/cm2	132.45		520.19	68,899.17	130.38	S/67,822.37	98.44%	0.00	0.00	0.00%	130.38	67,822.37	98.44%	2.07	1,076.80	1.56%
01.02.02.02	ENCOFRADO Y DESENCOFRADO DE VIGAS TRANSVERSALES	1,005.66		55.45	55,763.85	944.68	S/52,382.51	93.94%	0.00	0.00	0.00%	944.68	52,382.51	93.94%	60.98	3,381.34	6.06%
01.02.02.03	ACERO CORRUGADO VIGAS TRANSVERSALES FY= 4200 kg/cm2	33,940.52		4.52	153,411.15	33,940.52	S/153,411.15	100.00%	0.00	0.00	0.00%	33,940.52	153,411.15	100.00%	0.00	0.00	0.00%
01.02.03	FABRICACIÓN DE LOSAS NERVADAS EN MUELLE																
01.02.03.01	CONCRETO LOSAS NERVADAS f'c= 280 kg/cm2	201.46		438.44	88,328.12	189.76	S/83,198.37	94.19%	0.00	0.00	0.00%	189.76	83,198.37	94.19%	11.70	5,129.75	5.81%
01.02.03.02	ENCOFRADO Y DESENCOFRADO LOSAS NERVADAS	1,176.31		50.07	58,897.84	1,044.38	S/52,292.11	88.78%	0.00	0.00	0.00%	1,044.38	52,292.11	88.78%	131.93	6,605.73	11.22%
01.02.03.03	ACERO CORRUGADO LOSAS NERVADAS FY= 4200 kg/cm2	50,952.59		4.20	214,000.88	50,952.59	S/214,000.88	100.00%	0.00	0.00	0.00%	50,952.59	214,000.88	100.00%	0.00	0.00	0.00%
01.02.04	NUCLEOS LLENADOS EN SITU																
01.02.04.01	CONCRETO EN NÚCLEOS f'c=280 kg/cm2	149.11		465.68	69,437.54		S/0.00	0.00%	0.00	0.00	0.00%	0.00	0.00	0.00%	149.11	69,437.54	100.00%
01.02.04.02	ENCOFRADO Y DESENCOFRADO NÚCLEOS	290.85		50.07	14,562.86		S/0.00	0.00%	0.00	0.00	0.00%	0.00	0.00	0.00%	290.85	14,562.86	100.00%
01.02.04.03	ACERO CORRUGADO NÚCLEOS FY= 4200 kg/cm2	15,991.25		4.20	67,163.25		S/0.00	0.00%	0.00	0.00	0.00%	0.00	0.00	0.00%	15,991.25	67,163.25	100.00%
01.02.05	JUNTAS LONGITUDINALES Y TRANSVERSALES																
01.02.05.01	CONCRETO EN JUNTAS LONGITUDINALES Y TRANSVERSALES	45.43		465.68	21,155.84		S/0.00	0.00%	0.00	0.00	0.00%	0.00	0.00	0.00%	45.43	21,155.84	100.00%
01.02.05.02	ENCOFRADO Y DESENCOFRADO EN JUNTAS LONGITUDINALES Y	85.14		50.07	4,262.96		S/0.00	0.00%	0.00	0.00	0.00%	0.00	0.00	0.00%	85.14	4,262.96	100.00%
01.02.05.03	ACERO CORRUGADO JUNTAS LONG Y TRANSV FY= 4200 kg/cm2	1,956.86		4.20	8,218.81		S/0.00	0.00%	0.00	0.00	0.00%	0.00	0.00	0.00%	1,956.86	8,218.81	100.00%

LUDWING CAR RASCO BUSTAMANTE
 Ing. Supervisor - CIP 79040
 CESEL S.A.

000000



VALORIZACIÓN N° 18 DEL 01 AL 28 DE FEBRERO DEL 2019 (PRECIOS UNITARIOS)

Contrato N° 025-2017- FONDEPES Ejecucion de la Obra: MEJORAMIENTO DE LOS SERVICIOS DEL DESEMBARCADERO PESQUERO ARTESANAL DE SUPE, REGION LIMA, PROVINCIA DE BARRANCA, DISTRITO DE SUPE PUERTO



OBRA: MEJORAMIENTO DE LOS SERVICIOS DEL DESEMBARCADERO PESQUERO ARTESANAL DE SUPE, REGION LIMA, PROVINCIA DE BARRANCA, DISTRITO DE SUPE PUERTO
 SUB PRES: OBRAS PORTUARIAS
 PROP: FONDEPES
 CONT: CONSORCIO MARITIMO DEL NORTE
 SUP: CESEL

FECHA: sáb 02 Mar 2019

ITEM	DESCRIPCION	PRESUPUESTO			VAL. ACUM. ANTERIOR			VAL. ACTUAL			VAL. ACUM. ACTUAL			SALDOS			
		Und.	Metrado	Precio (S./.)	Parcial (S./.)	Metrado	Parcial (S./.)	%	Metrado	Parcial (S./.)	%	Metrado	Parcial (S./.)	%	Metrado	Parcial (S./.)	%
01.02.06	SARDINEL LLENADO EN SITU																
01.02.06.01	CONCRETO EN SARDINEL Fc=280 kg/cm2	m3	18.29	460.20	8,417.06												
01.02.06.02	ENCOFRADO Y DESENCOFRADO SARDINELES	m2	162.61	44.69	7,267.04		S/0.00	0.00%	0.00	0.00	0.00%	0.00	0.00	0.00%	18.29	8,417.06	100.00%
01.02.06.03	ACERO CORRUGADO SARDINELES FY= 4200 kg/cm2	kg	3,979.02	4.20	16,711.88		S/0.00	0.00%	0.00	0.00	0.00%	0.00	0.00	0.00%	162.61	7,267.04	100.00%
01.02.07	LOSAS VACIADAS EN SITU																
01.02.07.01	CONCRETO LOSAS IN SITU Fc=280 kg/cm2	m3	170.74	465.68	79,510.20		S/0.00	0.00%	0.00	0.00	0.00%	0.00	0.00	0.00%	3,979.02	16,711.88	100.00%
01.02.07.02	ENCOFRADO Y DESENCOFRADO LOSAS IN SITU	m2	85.00	44.69	3,798.65		S/0.00	0.00%	0.00	0.00	0.00%	0.00	0.00	0.00%	170.74	79,510.20	100.00%
01.02.07.03	ACERO CORRUGADO LOSAS IN SITU FY= 4200 kg/cm2	kg	19,194.16	4.20	80,615.47		S/0.00	0.00%	0.00	0.00	0.00%	0.00	0.00	0.00%	85.00	3,798.65	100.00%
01.02.08	MANIOBRAS DE COLOCACIÓN E HINCADO DE PILOTES,																
01.02.08.01	TRANSPORTE DE PILOTE	und	182.00	530.39	96,530.98	2.00	S/1,060.78	1.10%	0.00	0.00	0.00%	2.00	1,060.78	1.10%	19,194.16	80,615.47	100.00%
01.02.08.02	TRANSPORTE DE VIGAS TRANSVERSALES	und	42.00	683.52	28,707.84	1.00	S/683.52	2.38%	0.00	0.00	0.00%	1.00	683.52	2.38%	182.00	96,530.98	98.90%
01.02.08.03	TRANSPORTE DE LOSAS PREFABRICADAS	und	74.00	683.52	50,580.48		S/0.00	0.00%	0.00	0.00	0.00%	0.00	0.00	0.00%	42.00	28,707.84	97.62%
01.02.08.04	PUNTA DE PILOTES	und	182.00	354.74	64,562.68	182.00	S/64,562.68	100.00%	0.00	0.00	0.00%	182.00	64,562.68	100.00%	74.00	50,580.48	100.00%
01.02.08.05	HINCADO DE PILOTE (INC. MOV. POSIC. PLANTILLA)	und	182.00	2,024.98	368,546.36		S/0.00	0.00%	0.00	0.00	0.00%	0.00	0.00	0.00%	182.00	64,562.68	100.00%
01.02.08.06	DESCABEZADO DE PILOTE	und	182.00	72.02	13,107.64	2.00	S/144.04	1.10%	0.00	0.00	0.00%	2.00	144.04	1.10%	182.00	368,546.36	100.00%
01.02.08.07	COLOCACIÓN DE VIGAS TRANSVERSALES	und	42.00	2,790.36	117,195.12		S/0.00	0.00%	0.00	0.00	0.00%	0.00	0.00	0.00%	72.02	13,107.64	98.90%
01.02.08.08	COLOCACIÓN DE LOSA NERVADA	und	74.00	1,457.83	107,879.42		S/0.00	0.00%	0.00	0.00	0.00%	0.00	0.00	0.00%	42.00	117,195.12	100.00%
01.03	CABEZO																
01.03.01	FABRICACIÓN DE PILOTES DE CONCRETO																
01.03.01.01	CONCRETO EN PILOTES Fc=350 kg/cm2	m3	191.34	552.49	105,713.44	172.21	S/95,142.09	90.00%	19.13	10,571.34	10.00%	191.34	105,713.44	100.00%	74.00	107,879.42	100.00%
01.03.01.02	ENCOFRADO Y DESENCOFRADO	m2	1,298.54	44.69	58,031.75	1,168.69	S/52,228.58	90.00%	129.85	5,803.18	10.00%	1,298.54	58,031.75	100.00%	0.00	0.00	0.00%
01.03.01.03	ACERO CORRUGADO FY= 4200 kg/cm2	kg	59,277.02	4.20	248,963.48	54,285.00	S/227,997.00	91.58%	4,992.02	20,966.48	8.42%	59,277.02	248,963.48	100.00%	0.00	0.00	0.00%
01.03.02	FABRICACIÓN DE VIGAS TRANSVERSALES																
01.03.02.01	CONCRETO VIGAS TRANSVERSALES Fc=280 kg/cm2	m3	43.54	520.19	22,649.07	0.00	S/0.00	0.00%	0.00	0.00	0.00%	0.00	0.00	0.00%	43.54	22,649.07	100.00%
01.03.02.02	ENCOFRADO Y DESENCOFRADO DE VIGAS TRANSVERSALES	m2	324.98	55.45	18,020.14	0.00	S/0.00	0.00%	0.00	0.00	0.00%	0.00	0.00	0.00%	324.98	18,020.14	100.00%
01.03.02.03	ACERO CORRUGADO VIGAS TRANSVERSALES FY= 4200 kg/cm2	kg	10,948.85	4.52	49,488.80	6,569.31	S/29,693.28	60.00%	0.00	0.00	0.00%	6,569.31	29,693.28	60.00%	4,379.54	19,795.52	40.00%
01.03.03	FABRICACIÓN DE LOSAS NERVADAS EN MUELLE																
01.03.03.01	CONCRETO LOSAS NERVADAS Fc= 280 kg/cm2	m3	110.44	438.44	48,421.31	76.80	S/33,672.19	69.54%	0.00	0.00	0.00%	76.80	33,672.19	69.54%	110.44	48,421.31	30.46%
01.03.03.02	ENCOFRADO Y DESENCOFRADO LOSAS NERVADAS	m2	510.87	50.07	25,579.26	427.26	S/21,392.91	83.63%	0.00	0.00	0.00%	427.26	21,392.91	83.63%	510.87	25,579.26	16.37%
01.03.03.03	ACERO CORRUGADO LOSAS NERVADAS FY= 4200 kg/cm2	kg	21,510.32	4.20	90,343.34	21,510.32	S/90,343.34	100.00%	0.00	0.00	0.00%	21,510.32	90,343.34	100.00%	0.00	0.00	0.00%
01.03.04	NÚCLEOS LLENADOS EN SITU																
01.03.04.01	CONCRETO EN NÚCLEOS Fc=280 kg/cm2	m3	76.55	465.68	35,647.80		S/0.00	0.00%	0.00	0.00	0.00%	0.00	0.00	0.00%	76.55	35,647.80	100.00%
01.03.04.02	ENCOFRADO Y DESENCOFRADO NÚCLEOS	m2	161.62	50.07	8,092.31		S/0.00	0.00%	0.00	0.00	0.00%	0.00	0.00	0.00%	161.62	8,092.31	100.00%
01.03.04.03	ACERO CORRUGADO NÚCLEOS FY= 4200 kg/cm2	kg	8,537.98	4.20	35,859.52		S/0.00	0.00%	0.00	0.00	0.00%	0.00	0.00	0.00%	8,537.98	35,859.52	100.00%
01.03.05	JUNTAS LONGITUDINALES Y TRANSVERSALES																
01.03.05.01	CONCRETO EN JUNTAS LONGITUDINALES Y TRANSVERSALES	m3	35.03	465.68	16,312.77		S/0.00	0.00%	0.00	0.00	0.00%	0.00	0.00	0.00%	35.03	16,312.77	100.00%
01.03.05.02	ENCOFRADO Y DESENCOFRADO EN JUNTAS LONGITUDINALES Y	m2	149.90	50.07	7,505.49		S/0.00	0.00%	0.00	0.00	0.00%	0.00	0.00	0.00%	149.90	7,505.49	100.00%
01.03.05.03	ACERO CORRUGADO JUNTAS LONG Y TRANSV FY= 4200 kg/cm2	kg	2,335.86	4.20	9,810.61		S/0.00	0.00%	0.00	0.00	0.00%	0.00	0.00	0.00%	2,335.86	9,810.61	100.00%

LUDWIG CARRASCO BUSTAMANTE
 Ing. Supervisor - CIP 79040
 CESEL S.A.

000000



VALORIZACIÓN N° 18 DEL 01 AL 28 DE FEBRERO DEL 2019 (PRECIOS UNITARIOS)

Contrato N° 025-2017- FONDEPES Ejecución de la Obra: MEJORAMIENTO DE LOS SERVICIOS DEL DESEMBARCADERO PESQUERO ARTESANAL DE SUPE, REGION LIMA, PROVINCIA DE BARRANCA, DISTRITO DE SUPE PUERTO



OBRA: MEJORAMIENTO DE LOS SERVICIOS DEL DESEMBARCADERO PESQUERO ARTESANAL DE SUPE, REGION LIMA, PROVINCIA DE BARRANCA, DISTRITO DE SUPE PUERTO
 SUB PRES: OBRAS PORTUARIAS
 PROP: FONDEPES
 CONT: CONSORCIO MARITIMO DEL NORTE
 SUP: CESEL

FECHA: 14/02/2019

ITEM	DESCRIPCION	PRESUPUESTO			VAL. ACUM. ANTERIOR			VAL. ACTUAL			VAL. ACUM. ACTUAL			SALDOS			
		Und.	Metrado	Precio (S./.)	Parcial (S./.)	Metrado	Parcial (S./.)	%	Metrado	Parcial (S./.)	%	Metrado	Parcial (S./.)	%	Metrado	Parcial (S./.)	%
01.03.06	LOSAS VACIADAS EN SITU																
01.03.06.01	CONCRETO LOSAS IN SITU Fc=280 kg/cm2	m3	72.00	465.68	33,528.96		S/0.00	0.00%	0.00	0.00	0.00%	0.00	0.00	0.00%	72.0000	33,528.96	100.00%
01.03.06.02	ENCOFRADO Y DESENCOFRADO LOSAS IN SITU	m2	23.20	44.69	1,036.81		S/0.00	0.00%	0.00	0.00	0.00%	0.00	0.00	0.00%	23.2000	1,036.81	100.00%
01.03.06.03	ACERO CORRUGADO LOSAS IN SITU FY= 4200 kg/cm2	kg	11,802.92	4.20	49,572.26		S/0.00	0.00%	0.00	0.00	0.00%	0.00	0.00	0.00%	11,802.9200	49,572.26	100.00%
01.03.07	MANIOBRAS DE COLOCACIÓN E HINCADO DE PILOTES,																
01.03.07.01	TRANSPORTE DE PILOTE	und	47.00	530.39	24,928.33		S/0.00	-0.00%	0.00	0.00	0.00%	0.00	0.00	0.00%	47.0000	24,928.33	100.00%
01.03.07.02	TRANSPORTE DE VIGAS TRANSVERSALES	und	9.00	683.52	6,151.68		S/0.00	0.00%	0.00	0.00	0.00%	0.00	0.00	0.00%	9.0000	6,151.68	100.00%
01.03.07.03	TRANSPORTE DE LOSAS PREFABRICADAS	und	33.00	683.52	22,556.16		S/0.00	0.00%	0.00	0.00	0.00%	0.00	0.00	0.00%	33.0000	22,556.16	100.00%
01.03.07.04	TRANSPORTE DE PUNTA DE PILOTES	und	47.00	354.74	16,672.78	47.00	S/16,672.78	100.00%	0.00	0.00	0.00%	47.00	16,672.78	100.00%	0.0000	0.00	0.00%
01.03.07.05	HINCADO DE PILOTE (INC. MOV. POSIC. PLANTILLA)	und	47.00	2,024.98	95,174.06		S/0.00	0.00%	0.00	0.00	0.00%	0.00	0.00	0.00%	47.0000	95,174.06	100.00%
01.03.07.06	DESCABEZADO DE PILOTE	und	47.00	72.02	3,384.94		S/0.00	0.00%	0.00	0.00	0.00%	0.00	0.00	0.00%	47.0000	3,384.94	100.00%
01.03.07.07	COLOCACION DE VIGAS TRANSVERSALES	und	9.00	2,790.36	25,113.24		S/0.00	0.00%	0.00	0.00	0.00%	0.00	0.00	0.00%	9.0000	25,113.24	100.00%
01.03.07.08	COLOCACIÓN DE LOSA NERVADA	und	33.00	1,457.83	48,108.39		S/0.00	0.00%	0.00	0.00	0.00%	0.00	0.00	0.00%	33.0000	48,108.39	100.00%
01.04	OBRAS COMPLEMENTARIAS EN PUENTE Y CABEZO																
01.04.01	SUMINISTRO Y COLOCACION SARDINELES DE MADERA 8"x8"	und	82.60	121.26	10,016.08		S/0.00	0.00%	0.00	0.00	0.00%	0.00	0.00	0.00%	82.6000	10,016.08	100.00%
01.04.02	SUMINISTRO Y COLOCACION BITAS METÁLICAS 30 BRT	und	8.00	533.23	4,265.84		S/0.00	0.00%	0.00	0.00	0.00%	0.00	0.00	0.00%	8.0000	4,265.84	100.00%
01.04.03	SUMINISTRO Y MONTAJE PESCANTE CAP. W=500kg	und	3.00	1,633.81	4,901.43		S/0.00	0.00%	0.00	0.00	0.00%	0.00	0.00	0.00%	3.0000	4,901.43	100.00%
01.04.04	FABRICACIÓN DE PILOTES METÁLICOS H, PARANTES DE	m	768.00	415.10	318,796.80		S/0.00	0.00%	0.00	0.00	0.00%	0.00	0.00	0.00%	768.0000	318,796.80	100.00%
01.04.05	FABRICACIÓN DE VIGAS METÁLICOS (LARGEROS DE DEFENSA)	m	246.80	430.63	106,279.48		S/0.00	0.00%	0.00	0.00	0.00%	0.00	0.00	0.00%	246.8000	106,279.48	100.00%
01.04.06	SUMINISTRO Y COLOCACION DE BLOCKS DE JEBE HUECO 6"x6"	und	60.00	175.36	10,521.60		S/0.00	0.00%	0.00	0.00	0.00%	0.00	0.00	0.00%	60.0000	10,521.60	100.00%
01.04.07	HINCADO DE PARANTES METÁLICOS SECCIÓN H 8"x8"x6mm	und	64.00	752.53	48,161.92		S/0.00	0.00%	0.00	0.00	0.00%	0.00	0.00	0.00%	64.0000	48,161.92	100.00%
01.04.08	MONTAJE DE VIGAS H (6"x6"), LONG. C/PARANTES, INC.	und	246.80	123.34	30,440.31		S/0.00	0.00%	0.00	0.00	0.00%	0.00	0.00	0.00%	246.8000	30,440.31	100.00%
01.04.09	SUMINISTRO Y COLOCACION DE DEFENSAS TIPO D	m	224.00	752.50	168,560.00		S/0.00	0.00%	0.00	0.00	0.00%	0.00	0.00	0.00%	224.0000	168,560.00	100.00%
01.04.10	BARANDA DE TUBERIA DE ACERO, EN PUENTE Y ESCALINATA DE	m	258.40	151.46	39,137.26		S/0.00	0.00%	0.00	0.00	0.00%	0.00	0.00	0.00%	258.4000	39,137.26	100.00%
01.04.11	PINTURA DE PARANTES Y VIGAS LONGITUDINALES EN DEFENSA	m2	1,014.00	49.92	50,618.88		S/0.00	0.00%	0.00	0.00	0.00%	0.00	0.00	0.00%	1,014.0000	50,618.88	100.00%
01.05	ENROCADO DE PROTECCIÓN Y TERRAPLEN																
01.05.01	CORTE DE MATERIAL ARENA, EN UÑA DE ENROCADO	m3	1,092.15	2.71	2,959.73	0.00	S/0.00	0.00%	0.00	0.00	0.00%	0.00	0.00	0.00%	1,092.1500	2,959.73	100.00%
01.05.02	ELIMINACION DE MATERIAL ARENA EN UÑA DE ENROCADO	m3	1,638.23	8.30	13,597.31	0.00	S/0.00	0.00%	0.00	0.00	0.00%	0.00	0.00	0.00%	1,638.2300	13,597.31	100.00%
01.05.03	SUMINISTRO Y COLOCACION DE ROCA FILTRO > A 50kg	m3	3,003.42	154.21	463,157.40	0.00	S/0.00	0.00%	0.00	0.00	0.00%	0.00	0.00	0.00%	3,003.4200	463,157.40	100.00%
01.05.04	SUMINISTRO Y COLOCACION DE ROCA INTERMEDIA DE 0.3T A	m3	2,784.99	185.05	515,362.40	0.00	S/0.00	0.00%	0.00	0.00	0.00%	0.00	0.00	0.00%	2,784.9900	515,362.40	100.00%
01.05.05	SUMINISTRO Y COLOCACION DE ROCA CORAZA DE 3.0T A 4.0T	m3	2,784.99	154.21	429,473.31	0.00	S/0.00	0.00%	0.00	0.00	0.00%	0.00	0.00	0.00%	2,784.9900	429,473.31	100.00%
01.05.11	CONFORMACIÓN DE TERRAPLENES R=1.010 m3/día	m3	19,384.99	6.56	127,165.53	0.00	S/0.00	0.00%	0.00	0.00	0.00%	0.00	0.00	0.00%	19,384.9900	127,165.53	100.00%
01.05.12	CORTE DE MATERIAL GRAVA, EN ARENA DE OPERACIONES	m3	1,176.00	2.71	3,186.96	0.00	S/0.00	0.00%	0.00	0.00	0.00%	0.00	0.00	0.00%	1,176.0000	3,186.96	100.00%
01.05.13	ELIMINACION DE MATERIAL GRAVA, EN ARENA DE OPERACIONES	m3	186.30	8.33	1,551.88	0.00	S/0.00	0.00%	0.00	0.00	0.00%	0.00	0.00	0.00%	186.3000	1,551.88	100.00%
	COSTO DIRECTO				7,268,506.65		2,702,094.58	37.18%		146,045.99	2.01%		2,848,140.56	39.18%		4,420,366.09	60.82%
	GASTOS GENERALES		20.0839308%		1,459,801.84		542,686.80			29,331.78			572,018.58			887,783.27	
	UTILIDAD		2.3224783%		168,809.56		62,755.59			3,391.89			66,147.48			102,662.09	
	SUB TOTAL				8,897,118.06		3,307,536.97			178,769.65			3,486,306.62			5,410,811.44	
	IGV 18%	18.00%			1,601,481.25		595,356.65			32,178.54			627,535.19			973,946.06	
	PRESUPUESTO TOTAL				10,498,599.31		3,902,893.62			210,948.19			4,113,841.81			6,384,757.50	

LUDWIG CARRASCO BUSTAMANTE
 Ing. Supervisor - CIP 79040
 CESEL S.A.

000007



VALORIZACIÓN N° 18 DEL 01 AL 28 DE FEBRERO DEL 2019 (PRECIOS UNITARIOS)

Contrato N° 025-2017- FONDEPES Ejecución de la Obra: MEJORAMIENTO DE LOS SERVICIOS DEL DESEMBARCADERO PESQUERO ARTESANAL DE SUPE, REGION LIMA, PROVINCIA DE BARRANCA, DISTRITO DE SUPE PUERTO



OBRA: MEJORAMIENTO DE LOS SERVICIOS DEL DESEMBARCADERO PESQUERO ARTESANAL DE SUPE, REGION LIMA, PROVINCIA DE BARRANCA, DISTRITO DE SUPE PUERTO
 SUB PRES: OBRAS EN TIERRA - ESTRUCTURA
 PROP: FONDEPES
 CONT: CONSORCIO MARITIMO DEL NORTE
 SUP: CESEL

FECHA: 15b 02 Mar 2019

ITEM	DESCRIPCION	PRESUPUESTO			VAL. ACUM. ANTERIOR			VAL. ACTUAL			VAL. ACUM. ACTUAL			SALDOS			
		Und.	Metrado	Precio (S/.)	Parcial (S/.)	Metrado	Parcial (S/.)	%	Metrado	Parcial (S/.)	%	Metrado	Parcial (S/.)	%	Metrado	Parcial (S/.)	%
02	ESTRUCTURAS EN TIERRA																
02.01	OBRAS PRELIMINARES																
02.01.01	LIMPIEZA DEL TERRENO	m2	3,919.14	1.78	6,976.07	3,919.14	5/6,976.07	100.00%	-	0.00%	3,919.14	6,976.07	100.00%	0.00	0.00	0.00%	
02.01.02	TRAZO Y REPLANTEO EDIFICACIONES	m2	3,919.14	1.48	5,800.33	3,879.95	5/5,742.32	99.00%	-	0.00%	3,879.95	5,742.32	99.00%	39.19	58.00	1.00%	
02.02	DEMOLICIONES																
02.02.01	DEMOLICIÓN DE VIGAS Y LOSAS MATERIAL NOBLE	m3	113.59	70.76	8,037.63	113.59	5/8,037.63	100.00%	-	0.00%	113.59	8,037.63	100.00%	0.00	0.00	0.00%	
02.02.02	DEMOLICIÓN DE COLUMNAS Y MUROS	m3	136.46	53.07	7,241.93	136.46	5/7,241.93	100.00%	-	0.00%	136.46	7,241.93	100.00%	0.00	0.00	0.00%	
02.02.03	DEMOLICION DE PISO DE CONCRETO	m2	3,698.88	24.16	89,364.94	3,698.88	5/89,364.94	100.00%	-	0.00%	3,698.88	89,364.94	100.00%	0.00	0.00	0.00%	
02.02.04	DEMOLICIÓN DE CIMENTACIONES	m3	240.00	88.48	21,235.20	240.00	5/21,235.20	100.00%	-	0.00%	240.00	21,235.20	100.00%	0.00	0.00	0.00%	
02.02.05	DESMONTAJE Y DEMOLICION DE INFRAESTRUCTURA SANITARIA Y ELECTRICA MENORES	m2	260.00	5.78	1,502.80	260.00	5/1,502.80	100.00%	-	0.00%	260.00	1,502.80	100.00%	0.00	0.00	0.00%	
02.02.06	ELIMINACION MATERIAL PROCEDENTE DE DEMOLICIÓN	m3	1,070.88	23.27	24,919.38	1,070.88	5/24,919.38	100.00%	-	0.00%	1,070.88	24,919.38	100.00%	0.00	0.00	0.00%	
02.03	MOVIMIENTO DE TIERRAS																
02.03.01	CORTE MASIVO	m3	7,838.24	6.37	49,929.59	7,196.17	5/45,839.60	91.81%	175.44	1,117.55	2.24%	7,371.61	46,957.16	94.05%	466.63	2,972.43	5.95%
02.03.02	RELLENO MASIVO CON MATERIAL DE PRESTAMO	m3	8,104.56	86.18	698,450.98	7,139.61	5/615,291.70	88.09%	-	0.00%	7,139.61	615,291.70	88.09%	964.95	83,159.28	11.91%	
02.03.03	ELIMINACION DE MATERIAL EXCEDENTE CON EQUIPO	m3	7,935.91	10.00	79,359.10	7,355.00	5/73,550.01	92.68%	-	0.00%	7,355.00	73,550.01	92.68%	580.91	5,809.09	7.32%	
02.03.04	NIVELACION Y APISONADO PARA FALSO PISO, PATIO Y VEREDAS.	m2	3,919.14	8.28	32,450.48	0.00	5/0.00	0.00%	-	0.00%	0.00	0.00	0.00%	3,919.14	32,450.48	100.00%	
02.03.05	AFIRMADO PARA FALSO PISO Y VEREDAS	m2	1,242.59	27.52	34,196.08	0.00	5/0.00	0.00%	-	0.00%	0.00	0.00	0.00%	1,242.59	34,196.08	100.00%	
02.03.06	AFIRMADO PARA PATIO DE MANIOBRAS Y PASILLOS	m2	2,475.23	26.91	66,608.44	0.00	5/0.00	0.00%	-	0.00%	0.00	0.00	0.00%	2,475.23	66,608.44	100.00%	
02.04	CONCRETO SIMPLE																
02.04.01	CIMIENTO CORRIDO																
02.04.01.01	CONCRETO CICLOPEO f'c=210 kg/cm2 + 30% P.G.	m3	22.30	360.79	8,045.62	20.59	5/7,428.67	92.33%	-	0.00%	20.59	7,428.67	92.33%	1.71	616.95	7.67%	
02.04.01.02	ENCOFRADO Y DESENCOFRADO CIMIENTO CORRIDO	m2	130.06	55.45	7,211.83	58.18	5/3,226.08	44.73%	-	0.00%	58.18	3,226.08	44.73%	71.88	3,985.75	55.27%	
02.04.02	CIMIENOTOS																
02.04.02.01	CONCRETO f'c=175 kg/cm2 CIMIENOTOS CERCO PERIMETRICO	m3	41.81	390.84	16,341.02	41.81	5/16,341.02	100.00%	-	0.00%	41.81	16,341.02	100.00%	0.00	0.00	0.00%	
02.04.02.02	ENCOFRADO Y DESENCOFRADO CIMIENTO CERCO PERIMETRICO	m2	348.38	55.45	19,317.67	177.79	5/9,858.46	51.03%	25.06	1,389.58	7.19%	202.85	11,248.03	58.23%	145.53	8,069.64	41.77%
02.04.03	SOBRECIMIENOTOS																
02.04.03.01	CONCRETO SOBRECIMIENOTOS f'c=175 kg/cm2	m3	27.87	419.43	11,689.51	14.47	5/6,069.30	51.92%	2.24	939.52	8.04%	16.71	7,008.82	59.96%	11.16	4,680.69	40.04%
02.04.03.02	ENCOFRADO Y DESENCOFRADO DE SOBRECIMIENTO	m2	278.70	55.87	15,570.97	227.90	5/12,732.77	81.77%	35.92	2,006.85	12.89%	263.82	14,739.62	94.66%	14.88	831.35	5.34%
02.05	CONCRETO ARMADO																
02.05.01	ZAPATAS																
02.05.01.01	CONCRETO f'c=280 kg/cm2 ZAPATAS	m3	213.74	422.82	90,373.55	206.23	5/87,198.17	95.49%	2.00	845.64	0.94%	208.23	88,043.81	97.42%	5.51	2,329.74	2.58%
02.05.01.02	ENCOFRADO Y DESENCOFRADO DE ZAPATAS	m2	614.39	64.53	39,646.59	492.95	5/31,810.06	80.23%	4.74	305.87	0.77%	497.69	32,115.94	81.01%	116.70	7,530.65	18.99%
02.05.01.03	ACERO CORRUGADO ZAPATAS FY= 4200 kg/cm2	kg	5,809.38	4.22	24,515.58	5,809.38	5/24,515.58	100.00%	-	0.00%	5,809.38	24,515.58	100.00%	0.00	0.00	0.00%	
02.05.01.04	SOLIDO PARA ZAPATAS DE CONCRETO E=4" MEZCLA 1:2	m2	427.48	44.64	19,082.71	0.00	5/0.00	0.00%	-	0.00%	0.00	0.00	0.00%	427.48	19,082.71	100.00%	
02.05.01.05	ENCOFRADO Y DESENCOFRADO SOLADOS DE ZAPATAS	m2	122.88	64.53	7,929.45	0.00	5/0.00	0.00%	-	0.00%	0.00	0.00	0.00%	122.88	7,929.45	100.00%	

[Firma]
 LUDWIG CATRASCO BUSTAMANTE
 Ing. Supervisor - CIP 79040
 CESEL S.A.

MNRFC



VALORIZACIÓN N° 18 DEL 01 AL 28 DE FEBRERO DEL 2019 (PRECIOS UNITARIOS)

Contrato N° 025-2017- FONDEPES Ejecución de la Obra: MEJORAMIENTO DE LOS SERVICIOS DEL DESEMBARCADERO PESQUERO ARTESANAL DE SUPE, REGION LIMA, PROVINCIA DE BARRANCA, DISTRITO DE SUPE PUERTO



OBRA: MEJORAMIENTO DE LOS SERVICIOS DEL DESEMBARCADERO PESQUERO ARTESANAL DE SUPE, REGION LIMA, PROVINCIA DE BARRANCA, DISTRITO DE SUPE PUERTO
 SUB PRES OBRAS EN TIERRA - ESTRUCTURA
 PROP. FONDEPES
 CONT. CONSORCIO MARITIMO DEL NORTE
 SUP. CESEL

FECHA: eab 02 Mar 2019

ITEM	DESCRIPCION	PRESUPUESTO			VAL. ACUM. ANTERIOR			VAL. ACTUAL			VAL. ACUM. ACTUAL			SALDOS			
		Und.	Metrado	Precio (\$/.)	Parcial (\$/.)	Metrado	Parcial (\$/.)	%	Metrado	Parcial (\$/.)	%	Metrado	Parcial (\$/.)	%	Metrado	Parcial (\$/.)	%
02.05.02	VIGAS DE CIMENTACIÓN																
02.05.02.01	CONCRETO $f_c=280$ kg/cm ² VIGAS DE CIMENTACIÓN	m ³	193.34	463.24	89,562.82	125.03	S/57,918.90	64.67%		-	0.00%	125.03	57,918.90	64.67%	68.31	31,643.92	35.33%
02.05.02.02	ENCOFRADO Y DESENCOFADO DE VIGAS DE CIMENTACIÓN	m ²	1,128.33	55.45	62,565.90	857.14	S/47,528.41	75.97%		-	0.00%	857.14	47,528.41	75.97%	271.19	15,037.49	24.03%
02.05.02.03	ACERO CORRUGADO VIGAS DE CIMENTACIÓN $F_y= 4200$ kg/cm ²	kg	18,632.99	4.22	78,631.22	14,843.81	S/62,640.89	79.66%	1,502.01	6,595.48	8.39%	16,406.72	69,236.37	88.05%	2,226.27	9,394.85	11.95%
02.05.03	SOBRECIMENTOS REFORZADOS																
02.05.03.01	CONCRETO $f_c=280$ kg/cm ² SOBRECIMENTOS	m ³	62.54	415.72	25,999.13	62.54	S/25,999.13	100.00%		-	0.00%	62.54	25,999.13	100.00%	0.00	0.00	0.00%
02.05.03.02	ENCOFRADO Y DESENCOFADO DE SOBRECIMIENTO REFORZADO	m ²	611.27	43.78	26,761.40	611.27	S/26,761.40	100.00%		-	0.00%	611.27	26,761.40	100.00%	0.00	0.00	0.00%
02.05.03.03	ACERO CORRUGADO SOBRECIMIENTO $F_y= 4200$ kg/cm ²	kg	3,279.53	4.22	13,839.62	3,279.53	S/13,839.62	100.00%		-	0.00%	3,279.53	13,839.62	100.00%	0.00	0.00	0.00%
02.05.04	COLUMNAS Y PLACAS																
02.05.04.01	CONCRETO $f_c=210$ kg/cm ² COLUMNAS	m ³	178.49	534.42	95,388.63	178.49	S/95,388.63	100.00%		-	0.00%	178.49	95,388.63	100.00%	0.00	0.00	0.00%
02.05.04.02	ENCOFRADO Y DESENCOFADO COLUMNAS	m ²	1,784.90	58.69	104,755.78	1,784.90	S/104,755.78	100.00%		-	0.00%	1,784.90	104,755.78	100.00%	0.00	0.00	0.00%
02.05.04.03	ACERO CORRUGADO $F_y= 4200$ kg/cm ² COLUMNAS Y PLACAS	kg	29,933.86	4.22	126,320.89	29,933.86	S/126,320.89	100.00%		-	0.00%	29,933.86	126,320.89	100.00%	0.00	0.00	0.00%
02.05.05	LOSAS ARMADAS Y RAMPAS																
02.05.05.01	CONCRETO $f_c= 210$ kg/cm ² , LOSAS ARMADAS Y RAMPAS	m ³	658.45	398.20	262,194.79	322.64	S/128,474.65	49.00%	0.14	55.75	0.02%	322.78	128,530.40	49.02%	335.67	133,664.39	50.96%
02.05.05.02	ACERO CORRUGADO LOSAS ARMADAS Y RAMPAS $F_y= 4200$ kg/cm ²	kg	23,980.12	4.22	101,196.11	23,192.58	S/97,872.68	96.72%	29.39	124.03	0.12%	23,221.97	97,996.71	96.84%	758.15	3,199.40	3.16%
02.05.06	VIGAS																
02.05.06.01	CONCRETO $f_c=210$ kg/cm ² EN VIGAS	m ³	143.10	412.74	59,063.09	138.07	S/56,987.01	96.48%	1.64	676.89	1.15%	139.71	57,663.91	97.63%	3.39	1,399.19	2.37%
02.05.06.02	ENCOFRADO Y DESENCOFADO NORMAL EN VIGAS	m ²	912.92	67.27	61,412.13	912.92	S/61,412.13	100.00%		-	0.00%	912.92	61,412.13	100.00%	0.00	0.00	0.00%
02.05.06.03	ACERO $f_y=4200$ kg/cm ² GRADO 60 en VIGAS	kg	14,857.17	4.22	62,697.26	14,857.17	S/62,697.26	100.00%		-	0.00%	14,857.17	62,697.26	100.00%	0.00	0.00	0.00%
02.05.07	LOSAS ALIGERADAS																
02.05.07.01	LADRILLO HUECO DE ARCILLA $h=15$ cm PARA TECHO ALIGERADO	m ³	10,691.86	3.07	32,824.01	10,691.86	S/32,824.01	100.00%		-	0.00%	10,691.86	32,824.01	100.00%	0.00	0.00	0.00%
02.05.07.02	CONCRETO $f_c= 210$ kg/cm ² , LOSA ALIGERADA	m ³	115.52	401.61	46,393.99	115.52	S/46,393.99	100.00%		-	0.00%	115.52	46,393.99	100.00%	0.00	0.00	0.00%
02.05.07.03	ENCOFRADO Y DESENCOFADO NORMAL EN LOSAS ALIGERADAS	m ²	1,389.39	42.72	59,354.74	1,389.39	S/59,354.74	100.00%		-	0.00%	1,389.39	59,354.74	100.00%	0.00	0.00	0.00%
02.05.07.04	ACERO $f_y=4200$ kg/cm ² GRADO 60 en LOSAS ALIGERADAS	kg	7,212.92	4.22	30,438.52	7,212.92	S/30,438.52	100.00%		-	0.00%	7,212.92	30,438.52	100.00%	0.00	0.00	0.00%
02.05.08	ESCALERAS																
02.05.08.01	CONCRETO EN ESCALERAS $f_c=210$ kg/cm ²	m ³	7.64	412.74	3,153.33	6.13	S/2,530.10	80.24%		-	0.00%	6.13	2,530.10	80.24%	1.51	623.24	19.76%
02.05.08.02	ENCOFRADO Y DESENCOFADO NORMAL EN ESCALERAS	m ²	45.66	67.27	3,071.55	38.11	S/2,563.66	83.46%		-	0.00%	38.11	2,563.66	83.46%	7.55	507.89	16.54%
02.05.08.03	ACERO $f_y=4200$ kg/cm ² GRADO 60 en ESCALERAS	kg	1,416.81	4.22	5,978.94	757.40	S/3,196.23	53.46%		-	0.00%	757.40	3,196.23	53.46%	659.41	2,782.71	46.54%
02.06	ESTRUCTURAS SANITARIAS																
02.06.01	CISTERNA																
02.06.01.01	CONCRETO CISTENA $f_c=210$ kg/cm ²	m ³	40.83	546.13	22,298.49	0.00	S/0.00	0.00%		-	0.00%	0.00	0.00	0.00%	40.83	22,298.49	100.00%
02.06.01.02	ENCOFRADO Y DESENCOFADO EN CISTERNA	m ²	336.09	58.62	19,701.60	0.00	S/0.00	0.00%		-	0.00%	0.00	0.00	0.00%	336.09	19,701.60	100.00%
02.06.01.03	ACERO CORRUGADO CISTERNA $F_y= 4200$ kg/cm ²	kg	3,543.64	4.20	14,883.29	0.00	S/0.00	0.00%		-	0.00%	0.00	0.00	0.00%	3,543.64	14,883.29	100.00%
02.06.02	TANQUE ELEVADO																
02.06.02.01	CONCRETO $f_c=280$ kg/cm ² TANQUE ELEVADO	m ³	52.95	590.94	31,290.27		S/0.00	0.00%		-	0.00%	0.00	0.00	0.00%	52.95	31,290.27	100.00%
02.06.02.02	ENCOFRADO Y DESENCOFADO TANQUE ELEVADO	m ²	150.33	49.90	7,501.47		S/0.00	0.00%		-	0.00%	0.00	0.00	0.00%	150.33	7,501.47	100.00%
02.06.02.03	ACERO CORRUGADO $F_y= 4200$ kg/cm ² TANQUE ELEVADO	kg	1,878.59	4.20	7,890.08		S/0.00	0.00%		-	0.00%	0.00	0.00	0.00%	1,878.59	7,890.08	100.00%

LUDWIGO CARRASCO BUSTAMANTE
 Ing. Supervisor - CIP 79040
 CESEL S.A.

NUMERO 5



VALORIZACIÓN N° 18 DEL 01 AL 28 DE FEBRERO DEL 2019 (PRECIOS UNITARIOS)

Contrato N° 025-2017- FONDEPES Ejecución de la Obra: MEJORAMIENTO DE LOS SERVICIOS DEL DESEMBARCADERO PESQUERO ARTESANAL DE SUPE, REGION LIMA, PROVINCIA DE BARRANCA, DISTRITO DE SUPE PUERTO



OBRA: MEJORAMIENTO DE LOS SERVICIOS DEL DESEMBARCADERO PESQUERO ARTESANAL DE SUPE ,REGION LIMA, PROVINCIA DE BARRANCA, DISTRITO DE SUPE PUERTO
 SUB PRES: OBRAS EN TIERRA - ESTRUCTURA
 PROP: FONDEPES
 CONT: CONSORCIO MARITIMO DEL NORTE
 SUP: CESEL

FECHA: 04b 02 Mar 2019

ITEM	DESCRIPCION	PRESUPUESTO			VAL. ACUM. ANTERIOR			VAL. ACTUAL			VAL. ACUM. ACTUAL			SALDOS			
		Und.	Metrado	Precio (\$/.)	Parcial (\$/.)	Metrado	Parcial (\$/.)	%	Metrado	Parcial (\$/.)	%	Metrado	Parcial (\$/.)	%	Metrado	Parcial (\$/.)	%
02.06.03	TANQUE SÉPTICO																
02.06.03.01	CONCRETO Fc=280 kg/cm2 TANQUE SÉPTICO	m3	20.18	589.76	11,901.36		5/0.00	0.00%		-	0.00%	0.00	0.00	0.00%	20.18	11,901.36	100.00%
02.06.03.02	ENCOFRADO Y DESENCOFRADO EN TANQUE SÉPTICO	m2	128.75	49.90	6,424.63		5/0.00	0.00%		-	0.00%	0.00	0.00	0.00%	128.75	6,424.63	100.00%
02.06.03.03	ACERO CORRUGADO TANQUE SÉPTICO FY= 4200 kg/cm2	m	1,027.85	4.20	4,316.97		5/0.00	0.00%		-	0.00%	0.00	0.00	0.00%	1,027.85	4,316.97	100.00%
02.06.04	ESTRUCTURAS SANITARIAS MENORES																
02.06.04.01	TRAMPA DE GRASAS	und	1.00	1,036.44	1,036.44		5/0.00	0.00%		-	0.00%	0.00	0.00	0.00%	1.00	1,036.44	100.00%
02.06.04.02	TRAMPA DE SÓLIDOS	und	1.00	885.76	885.76		5/0.00	0.00%		-	0.00%	0.00	0.00	0.00%	1.00	885.76	100.00%
02.06.04.03	CÁMARA DE REUNIÓN	und	1.00	1,803.54	1,803.54		5/0.00	0.00%		-	0.00%	0.00	0.00	0.00%	1.00	1,803.54	100.00%
02.07	ESTRUCTURA METÁLICA Y COBERTURAS																
02.07.01	COBERTURA EN TIERRA																
02.07.01.01	ARRIOSTRE DE TUBERIALES	m	80.00	244.97	19,597.60		5/0.00	0.00%		-	0.00%	0.00	0.00	0.00%	80.00	19,597.60	100.00%
02.07.01.02	TUBERIAL METÁLICO SEGÚN DETALLE	und	20.00	602.48	12,049.60		5/0.00	0.00%		-	0.00%	0.00	0.00	0.00%	20.00	12,049.60	100.00%
02.07.01.03	ANCLAJE DE TUBERIAL CON LOSA SEGÚN DETALLE CORREAS METÁLICAS	und	20.00	585.02	11,700.40	9.00	5/5,265.18	45.00%		-	0.00%	9.00	5,265.18	45.00%	11.00	6,435.22	55.00%
02.07.01.04	CORREAS METÁLICAS	m	120.00	1.57	188.40		5/0.00	0.00%		-	0.00%	0.00	0.00	0.00%	120.00	188.40	100.00%
02.07.02	COBERTURA EN CABEZO																
02.07.02.01	POSTE METÁLICO	und	80.00	348.29	27,863.20		5/0.00	0.00%		-	0.00%	0.00	0.00	0.00%	80.00	27,863.20	100.00%
02.07.02.02	ARCO PRINCIPAL TUB 1 1/2" E=3mm	m	50.00	27.53	1,376.50		5/0.00	0.00%		-	0.00%	0.00	0.00	0.00%	50.00	1,376.50	100.00%
02.07.02.03	LARGUERO METÁLICO EN ARCO	m	110.00	43.35	4,768.50		5/0.00	0.00%		-	0.00%	0.00	0.00	0.00%	110.00	4,768.50	100.00%
02.07.02.04	CORREAS METÁLICAS	m	500.00	1.57	785.00		5/0.00	0.00%		-	0.00%	0.00	0.00	0.00%	500.00	785.00	100.00%
02.07.03	ARMADURAS PARA TUBERIA COLGADA EN TAREAS PREVIAS																
02.07.03.01	ARMADURA METÁLICA TIPO 1 TUBERIA COLGADA	und	7.00	304.16	2,129.12		5/0.00	0.00%		-	0.00%	0.00	0.00	0.00%	7.00	2,129.12	100.00%
02.07.03.02	ARMADURA METÁLICA TIPO 2 TUBERIA COLGADA	und	7.00	216.52	1,515.64		5/0.00	0.00%		-	0.00%	0.00	0.00	0.00%	7.00	1,515.64	100.00%
02.08	VARIOS																
02.08.01	LIMPIEZA DURANTE LA EJECUCION DE OBRA	m2	10.00	849.99	8,499.90	9.00	5/7,649.91	90.00%		-	0.00%	9.00	7,649.91	90.00%	1.00	849.99	10.00%
02.08.02	DESMONTAJE DE EQUIPOS DE FRIO EXISTENTES	gh	1.00	38,517.63	38,517.63	1.00	5/38,517.63	100.00%		-	0.00%	1.00	38,517.63	100.00%	0.00	0.00	0.00%
02.08.03	TOMA DE MUESTRAS PARA ENSAYO DE COMPRESIÓN	und	200.00	51.35	10,270.00	200.00	5/10,270.00	100.00%		-	0.00%	200.00	10,270.00	100.00%	0.00	0.00	0.00%
02.08.04	ROTURA DE PROBETA- ENSAYO DE COMPRESIÓN	und	200.00	45.51	9,102.00	200.00	5/9,102.00	100.00%		-	0.00%	200.00	9,102.00	100.00%	0.00	0.00	0.00%
	COSTO DIRECTO			3,015,698.69		2,315,585.04	2.53%		14,057.16	0.47%		2,329,642.20	77.25%		686,056.44	22.75%	
	GASTOS GENERALES		20.083931%	605,670.84		465,060.50			2,823.23			467,883.73			137,787.10		
	UTILIDAD		2.32247929%	70,038.98		53,778.98			326.47			54,105.45			15,933.52		
	SUB TOTAL			3,691,408.51		2,834,424.52			17,206.86			2,851,631.38			839,777.06		
	IGV 18%		18.00%	664,453.53		510,196.41			3,097.24			513,293.65			151,159.87		
	PRESUPUESTO TOTAL			4,355,862.04		3,344,620.93			20,304.10			3,364,925.03			990,936.93		

LUDWING CARRASCO BUSTAMANTE
 Ing. Supervisor - CIP 79040
 CESEL S.A.

0000054

OBRA: MEJORAMIENTO DE LOS SERVICIOS DEL DESEMBARCADERO PESQUERO ARTESANAL DE SUPE, REGION LIMA, PROVINCIA DE BARRANCA, DISTRITO DE SUPE PUERTO
SUB PRES: OBRAS EN TIERRA - ARQUITECTURA
PROP: FONDEPES
CONT: CONSORCIO MARITIMO DEL NORTE
SUP: CESEL

FECHA: sdb 02 Mar 2019

ITEM	DESCRIPCION	PRESUPUESTO				VAL. ACUM. ANTERIOR			VAL. ACTUAL			VAL. ACUM. ACTUAL			SALDOS		
		Und.	Metrado	Preco (S/.)	Parcial (S/.)	Metrado	Parcial (S/.)	%	Metrado	Parcial (S/.)	%	Metrado	Parcial (S/.)	%	Metrado	Parcial (S/.)	%
03	ARQUITECTURA																
03.01	ALBAÑILERIA																
03.01.01	MURO DE LADRILLO KING KONG E=0.15m.	m ²	1,296.96	60.33	78,245.60	760.7000	45,893.03	0.00%									
03.01.02	MURO DE LADRILLO KING KONG E=0.25m	m ²	749.28	95.84	71,811.00	749.2800	71,811.00	0.00%	188.49	11,371.60	14.53%	949.19	57,264.63	73.19%	347.77	20,980.96	26.81%
03.01.03	MURO LADRILLO KING KONG E=0.10m.	m ²	17.70	49.54	876.96	6.7200	332.91	0.00%		0.00	0.00%	6.72	332.91	37.97%	10.98	543.95	62.03%
03.02	REVOQUES ENLUCIDOS Y MOLDURAS																
03.02.01	TARRAJEO EN INTERIORES ACABADO CON CEMENTO-ARENA MEZCLA 1:5	m ²	2,735.63	33.24	90,932.34	2,503.1500	83,204.71	0.00%	186.02	6,183.30	6.80%	2,689.17	89,388.01	98.30%	46.46	1,544.33	1.70%
03.02.02	TARRAJEO EN EXTERIORES ACABADO CEMENTO- ARENA MEZCLA 1:5	m ²	3,183.98	42.66	135,628.59	1,670.7500	71,274.20	0.00%	851.00	36,303.66	26.73%	2,521.75	107,577.86	79.20%	662.23	28,250.73	20.80%
03.02.03	TARRAJEO CON IMPERMEABILIZANTES	m ²	270.07	34.89	9,420.04	0.0000	0.00	0.00%		0.00	0.00%	0.00	0.00	0.00%	270.07	9,420.04	100.00%
03.02.04	TARRAJEO DEL TIPO RAYADO O PRIMARIO C/MORTERO 1:5	m ²	276.72	26.91	7,446.54	276.7200	7,446.54	0.00%		0.00	0.00%	276.72	7,446.54	100.00%	0.00	0.00	0.00%
03.02.05	VESTIDURA DE DERRAMES ANCHO = 15cm	m	662.75	12.72	8,430.18	539.5200	6,862.69	0.00%	123.23	1,567.49	18.59%	662.75	8,430.18	100.00%	0.00	0.00	0.00%
03.03	CIELORRASOS																
03.03.01	CIELORRASOS CON MEZCLA DE CEMENTO ARENA	m ²	1,760.09	48.76	85,821.99	1,570.6560	76,585.19	0.00%		0.00	0.00%	1,570.66	76,585.19	89.24%	189.43	9,236.80	10.76%
03.04	PISOS Y PAVIMENTOS																
03.04.01	FALSO PISO DE CONCRETO E=2"	m ²	1,308.33	25.95	33,951.16	0.0000	0.00	0.00%		0.00	0.00%	0.00	0.00	0.00%	1,308.33	33,951.16	100.00%
03.04.02	CONTRAPISO DE 25mm	m ²	447.90	17.29	7,744.19	0.0000	0.00	0.00%		0.00	0.00%	0.00	0.00	0.00%	447.90	7,744.19	100.00%
03.04.03	PISO DE CEMENTO PULIDO CON IMPERMEABILIZANTE	m ²	3,144.88	54.37	170,987.13	0.0000	0.00	0.00%		0.00	0.00%	0.00	0.00	0.00%	3,144.88	170,987.13	100.00%
03.04.04	PISO DE CERAMICO ANTIDESLIZANTE ALTO TRAFICO	m ²	366.75	65.34	23,963.45	209.2600	13,673.05	0.00%		0.00	0.00%	209.26	13,673.05	57.06%	157.49	10,290.40	42.94%
03.04.05	PISO DE VINILICO ALTO TRAFICO VEREDA	m ²	116.80	34.47	4,026.10	0.0000	0.00	0.00%		0.00	0.00%	0.00	0.00	0.00%	116.80	4,026.10	100.00%
03.04.06	VEREDA	m ²	468.00	67.73	31,697.64	0.0000	0.00	0.00%		0.00	0.00%	0.00	0.00	0.00%	468.00	31,697.64	100.00%
03.05	ZOCALOS Y CONTRAZOCALOS																
03.05.01	ZOCALO DE CERAMICA COLOR 0.40 X 0.40m	m ²	331.80	54.79	18,179.32	127.3500	6,977.51	0.00%		0.00	0.00%	127.35	6,977.51	38.38%	204.45	11,201.82	61.62%
03.05.02	CONTRAZOCALO DE CERAMICA H=0.10 m.	m	294.60	10.81	3,184.63	66.9000	723.19	0.00%		0.00	0.00%	66.90	723.19	22.71%	227.70	2,461.44	77.29%
03.05.03	CONTRAZOCALO DE CEMENTO DISEÑO SANITARIO H=10 cm	m	546.00	12.19	6,655.74	0.0000	0.00	0.00%		0.00	0.00%	0.00	0.00	0.00%	546.00	6,655.74	100.00%
03.05.04	CONTRAZOCALO DE CEDRO DE E=1", H=0.10m	m	98.20	21.91	2,151.56	0.0000	0.00	0.00%		0.00	0.00%	0.00	0.00	0.00%	98.20	2,151.56	100.00%
03.06	COBERTURAS																
03.06.01	CUBIERTA LADRILLO PASTELERO 24x24 ASENTADO C/MEZCLA 1:5 2.5cm JUNTA	m ²	1,295.40	65.17	84,421.22	1,191.4200	77,644.84	0.00%		0.00	0.00%	1,191.42	77,644.84	91.97%	103.98	6,776.38	8.03%
03.06.02	POLICARBONATO COLOR BLANCO, E=16mm (INC. ACCESORIO, PROVISIÓN Y	m ²	520.00	192.79	100,250.80	0.0000	0.00	0.00%		0.00	0.00%	0.00	0.00	0.00%	520.00	100,250.80	100.00%
03.07	CARPINTERIA DE MADERA																
03.07.01	PUERTA APANELADA DE MADERA, CON MARCO DE MAD. CEDRO 1 1/2"x6"	m ²	65.04	291.13	18,935.10	0.0000	0.00	0.00%		0.00	0.00%	0.00	0.00	0.00%	65.04	18,935.10	100.00%
03.07.02	PUERTA CONTRAPLACADA E=45mm, TRIPLAY LUPUNA 6mm, CON MARCO DE	m ²	13.20	230.98	3,048.94	0.0000	0.00	0.00%		0.00	0.00%	0.00	0.00	0.00%	13.20	3,048.94	100.00%
03.07.03	TABIQUE DE MELAMINE PARA BAÑOS Y VESTIDORES, E=15mm	m ²	68.60	183.75	12,605.25	0.0000	0.00	0.00%		0.00	0.00%	0.00	0.00	0.00%	68.60	12,605.25	100.00%

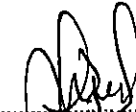

LUDWING CARRASCO BUSTAMANTE
Ing. Supervisor - CIP 79040
CESEL S.A.

000003

OBRA: MEJORAMIENTO DE LOS SERVICIOS DEL DESEMBARCADERO PESQUERO ARTESANAL DE SUPE, REGION LIMA, PROVINCIA DE BARRANCA, DISTRITO DE SUPE PUERTO
SUB PRES: OBRAS EN TIERRA - ARQUITECTURA
PROP: FONDEPES
CONT: CONSORCIO MARITIMO DEL NORTE
SUP: CESEL

FECHA: sáb 02 Mar 2019

ITEM	DESCRIPCION	PRESUPUESTO			VAL. ACUM. ANTERIOR			VAL. ACTUAL			VAL. ACUM. ACTUAL			SALDOS			
		Und.	Metrado	Precio (\$/.)	Parcial (\$/.)	Metrado	Parcial (\$/.)	%	Metrado	Parcial (\$/.)	%	Metrado	Parcial (\$/.)	%	Metrado	Parcial (\$/.)	%
03.08	CARPINTERIA METALICA																
03.08.01	PUERTA DE ALTO IMPACTO BARRA ANTIPANICO	m2	15.84	1,129.74	17,895.08	0.0000	0.00	0.00%		0.00	0.00%	0.00	0.00	0.00%	15.84	17,895.08	100.00%
03.08.02	PUERTA DE ALTO IMPACTO, TIPO VAIVEN	m2	30.24	1,007.87	30,477.99	0.0000	0.00	0.00%		0.00	0.00%	0.00	0.00	0.00%	30.24	30,477.99	100.00%
03.08.03	PUERTA METALICA, PLANCHA 1/16", MARCO 3"X3"X3mm Y REFUERZOS	m2	80.40	262.04	21,068.02	0.0000	0.00	0.00%		0.00	0.00%	0.00	0.00	0.00%	80.40	21,068.02	100.00%
03.08.04	PUERTA METALICA, TUBO GALVANIZADO 2", MALLA GALVANIZADA N°8	m2	69.77	174.07	12,144.86	0.0000	0.00	0.00%		0.00	0.00%	0.00	0.00	0.00%	69.77	12,144.86	100.00%
03.08.05	PUERTA SECCIONABLE PS 2.60X3.00	und	8.00	4,347.63	34,781.04	0.0000	0.00	0.00%		0.00	0.00%	0.00	0.00	0.00%	8.00	34,781.04	100.00%
03.08.06	SUMINISTRO E INSTALACIÓN DE ABRIGO RETRACTIL	und	8.00	4,820.93	38,567.44	0.0000	0.00	0.00%		0.00	0.00%	0.00	0.00	0.00%	8.00	38,567.44	100.00%
03.08.07	BARANDA DE TUBO FIERRO GALVANIZADO PASAMANO 1 1/2" PARANTE 1"X1m	m	82.30	136.00	11,192.80	0.0000	0.00	0.00%		0.00	0.00%	0.00	0.00	0.00%	82.30	11,192.80	100.00%
03.09	CARPINTERIA DE ALUMINIO																
03.09.01	VENTANA DE ALUMINIO, C/VIDRIO TEMPLADO	m2	227.37	197.68	44,946.50	0.0000	0.00	0.00%		0.00	0.00%	0.00	0.00	0.00%	227.37	44,946.50	100.00%
03.09.02	VENTANA DE ALUMINIO CON MALLA MOSQUITERA	m2	128.86	114.84	14,798.28	0.0000	0.00	0.00%		0.00	0.00%	0.00	0.00	0.00%	128.86	14,798.28	100.00%
03.09.03	PUERTA ENROLLABLE DE ALUMINIO	m2	29.70	483.43	14,357.87	0.0000	0.00	0.00%		0.00	0.00%	0.00	0.00	0.00%	29.70	14,357.87	100.00%
03.10	CERRAJERIA																
03.10.01	CERRADURA DOS GOLPES EN PUERTA CON TIRADOR	und	15.00	95.93	1,438.95	0.0000	0.00	0.00%		0.00	0.00%	0.00	0.00	0.00%	15.00	1,438.95	100.00%
03.10.02	CERRADURA DE PERILLA PARA PUERTAS INTERIORES	und	33.00	64.53	2,129.49	0.0000	0.00	0.00%		0.00	0.00%	0.00	0.00	0.00%	33.00	2,129.49	100.00%
03.10.03	BISAGRA CAPUCHINA DE 3"	m	235.00	12.35	2,902.25	0.0000	0.00	0.00%		0.00	0.00%	0.00	0.00	0.00%	235.00	2,902.25	100.00%
03.11	PINTURA																
03.11.01	PINTURA EN MUROS Y COLUMNAS INTERIORES CON EPOXICO	m2	1,892.61	18.51	35,032.21	0.0000	0.00	0.00%		0.00	0.00%	0.00	0.00	0.00%	1,892.61	35,032.21	100.00%
03.11.02	PINTURA EN MUROS Y COLUMNAS INTERIORES CON LATEX	m2	843.02	16.40	13,825.53	0.0000	0.00	0.00%	56.78	931.19	6.74%	56.78	931.19	6.74%	786.24	12,894.34	93.26%
03.11.03	PINTURA EN PISO CON EPOXICO	m2	868.73	19.38	16,835.99	0.0000	0.00	0.00%		0.00	0.00%	0.00	0.00	0.00%	868.73	16,835.99	100.00%
03.11.04	PINTURA EN MUROS, COLUMNAS Y VIGAS EXTERIORES CON LATEX	m2	3,183.98	16.91	53,841.10	0.0000	0.00	0.00%	104.97	1,775.04	3.30%	104.97	1,775.04	3.30%	3,079.01	52,066.06	96.70%
03.11.05	PINTURA EN CIELO RASO CON EPOXICO	m2	879.29	20.73	18,227.68	0.0000	0.00	0.00%		0.00	0.00%	0.00	0.00	0.00%	879.29	18,227.68	100.00%
03.11.06	PINTURA EN CIELO RASO CON LATEX	m2	880.80	18.62	16,400.50	0.0000	0.00	0.00%	260.80	4,857.86	29.62%	260.80	4,857.86	29.62%	619.91	11,542.63	70.38%
03.12	OTROS																
03.12.01	CORTINA DE TRASLAPE DE PVC (PROVISION Y COLOCACIÓN)	m2	59.52	61.95	3,687.26	0.0000	0.00	0.00%		0.00	0.00%	0.00	0.00	0.00%	59.52	3,687.26	100.00%
03.12.02	PROTECCION DE MADERA DE BORDE DE PLATRAFORMA	m	29.40	165.81	4,874.81	0.0000	0.00	0.00%		0.00	0.00%	0.00	0.00	0.00%	29.40	4,874.81	100.00%
	COSTO DIRECTO				1,420,041.02		462,428.84		62,990.15		4.44%	525,418.99		37.00%	894,622.00		63.00%
	GASTOS GENERALES				20,083,993.1%		285,200.06		92,873.89			105,524.79			179,675.26		
	UTILIDAD				2,322,492.5%		32,980.16		10,739.81			12,202.74			20,777.41		
	SUB TOTAL				1,738,221.23		566,042.54		77,103.98			643,146.52			1,095,074.68		
	IGV 18%				312,879.82		101,887.66		13,878.72			115,766.37			197,113.44		
	PRESUPUESTO TOTAL				2,051,101.05		667,930.20		90,982.70			758,912.89			1,292,188.12		

LUDWING CARRASCO BUSTAMANTE
Ing. Supervisor - CIP 79040
CESEL S.A.

000052



Fecha: 06/03/19

MEMORANDO INTERNO N° 917 -2019-FONDEPES/DIGENIPAA/AOEM

Asunto : Memo Interno N°1583-2019-DIGENIPAA

Referencia : _____ Registro: 2085

Destino	Indicación	Destino	Indicación

Observaciones:

José Luis Tello

Atentamente,



Indicaciones:

- | | | | |
|---------------------------|--------------------------|-----------------------------|--------------------------|
| 01. Autorizado/ Aprobado | 02. Calificar/ Evaluar | 03. Informe | 04. Proyectar resolución |
| 05. Atención/ Tramitación | 06. Conocimiento y fines | 07. Notificar al interesado | 08. Reformular |
| 09. Ayuda memoria | 10. Coordinar | 11. Opinión/ Recomend | 12. Consolidar |
| 13. Aclarar redacción | 14. Implementar/ Ejecut | 15. Preparar respuesta | 16. Visación |
| 17. Agregar a anteced | 18. Archivo | 19. Ampliar | 20. Seguimiento |



Fecha: 05/03/19

MEMORANDUM INTERNO N° 1583 - 2019 - FONDEPES/ DIGENIPAA

Asunto : CSL. 174302. PU. DPA. S. 324. 19

Referencia : _____ Registro : 2085

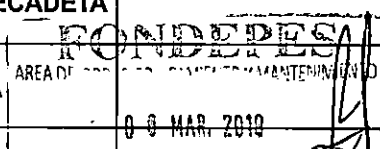
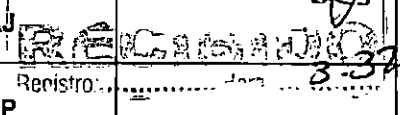
Destino	Indicación	Destino	Indicación
JEFATURA		DIGECADETA	
SG		OGA	
OCI		OGAJ	
DIGEPROFIN		OGPP	
DIGECADEPA		OTROS	ADEM
Observaciones: _____			

Atentamente



Indicaciones:

- | | | | |
|--------------------------------|--------------------------|-----------------------------|-----------------|
| 01. Autorización FONDEPES | 02. Calificar/Evaluar | 03. Informe | 04. Proyectar |
| 05. Atención y recepción | 06. Conocimiento y fines | 07. Notificar al interesado | 08. Reformular |
| 09. Ayuda memoria | 10. Coordinar | 11. Opinión/Recomendación | 12. Consoliar |
| 13. Aclarar redacción | 14. Implementar/Ejecutar | 15. Preparar respuesta | 16. Visación |
| 17. Agregar a sus antecedentes | 18. Archivo | 19. Ampliar | 20. Seguimiento |

OBRA: MEJORAMIENTO DE LOS SERVICIOS DEL DESEMBARCADERO PESQUERO ARTESANAL DE SUPE, REGION LIMA, PROVINCIA DE BARRANCA, DISTRITO DE SUPE PUERTO
 SUB PRES: OBRAS EN TIERRA - INSTALACIONES ELECTRICAS
 PROP.: FONDEPES
 CONT.: CONSORCIO MARITIMO DEL NORTE
 SUP.: CESEL

FECHA: 02 Mar 2019

ITEM	DESCRIPCION	PRESUPUESTO			VAL. ACUM. ANTERIOR			VAL. ACTUAL			VAL. ACUM. ACTUAL			SALDOS			
		Und.	Metrado	Precio (S/.)	Parcial (S/.)	Metrado	Parcial (S/.)	%	Metrado	Parcial (S/.)	%	Metrado	Parcial (S/.)	%	Metrado	Parcial (S/.)	%
04	INSTALACIONES ELECTRICAS																
04.01	BAJA TENSION																
04.01.01	TRabajos PRELIMINARES																
04.01.01.01	TRAZO Y REPLANTEO	und	4.00	796.97	3,187.88	0.8000	637.58	20.00%	0.00	0.00	0.00%	0.8000	637.58	20.00%	3.2000	2,550.30	80.00%
04.01.02	MOVIMIENTO DE TIERRAS																
04.01.02.01	EXCAVACION DE ZANJA DE 0.50X0.60m PARA INSTALACION DE	m3	440.00	13.49	5,935.60	5.6500	76.22	1.28%	0.00	0.00	0.00%	5.6500	76.22	1.28%	434.3500	5,859.38	98.72%
04.01.02.02	RELLENO COMPACTADO DE ZANJAS	m	352.00	14.82	5,216.64	47.0000	696.54	13.35%	0.00	0.00	0.00%	47.0000	696.54	13.35%	305.0000	4,520.10	86.65%
04.01.02.03	ELIMINACION DE MATERIAL EXCEDENTE	m3	44.00	12.74	560.56	2.3900	30.45	5.43%	0.00	0.00	0.00%	2.3900	30.45	5.43%	41.6100	530.11	94.57%
04.01.03	SALIDAS DE ILUMINACION																
04.01.03.01	SALIDA PARA LUMINARIA DE TECHO (CENTRO DE LUZ)	pto	219.00	27.22	5,961.18	75.0000	2,041.50	34.25%	0.00	0.00	0.00%	75.0000	2,041.50	34.25%	144.0000	3,919.68	65.75%
04.01.03.02	SALIDA PARA LUMINARIA DE PARED	pto	40.00	27.22	1,088.80	25.0000	680.50	62.50%	0.00	0.00	0.00%	25.0000	680.50	62.50%	15.0000	408.30	37.50%
04.01.04	SALIDA DE INTERRUPTOR																
04.01.04.01	INTERRUPTOR UNIPOLAR SIMPLE	pto	28.00	32.99	923.72	28.0000	923.72	100.00%	0.00	0.00	0.00%	28.0000	923.72	100.00%	0.0000	0.00	0.00%
04.01.04.02	INTERRUPTOR UNIPOLAR DOBLE	pto	9.00	36.14	325.26	4.0000	144.56	44.44%	0.00	0.00	0.00%	4.0000	144.56	44.44%	5.0000	180.70	55.56%
04.01.04.03	INTERRUPTOR UNIPOLAR TRIPLE	pto	3.00	37.72	113.16	3.0000	113.16	100.00%	0.00	0.00	0.00%	3.0000	113.16	100.00%	0.0000	0.00	0.00%
04.01.04.04	INTERRUPTOR UNIPOLAR DE CONMUTACION SIMPLE	pto	9.00	38.25	344.25	4.0000	153.00	44.44%	0.00	0.00	0.00%	4.0000	153.00	44.44%	5.0000	191.25	55.56%
04.01.05	SALIDA PARA TOMACORRIENTES																
04.01.05.01	SALIDA DE TOMACORRIENTE BIPOLAR DOBLE CON LINEA DE	pto	28.00	38.25	1,071.00	28.0000	1,071.00	100.00%	0.00	0.00	0.00%	28.0000	1,071.00	100.00%	0.0000	0.00	0.00%
04.01.05.02	SALIDA DE TOMACORRIENTE BIPOLAR DOBLE CON LINEA DE	pto	29.00	60.70	1,760.30	23.0000	1,396.10	79.31%	0.00	0.00	0.00%	23.0000	1,396.10	79.31%	6.0000	364.20	20.69%
04.01.05.03	SALIDA DE TOMACORRIENTE BIPOLAR DOBLE CON LINEA	pto	50.00	60.70	3,035.00	0.0000	0.00	0.00%	0.00	0.00	0.00%	0.0000	0.00	0.00%	50.0000	3,035.00	100.00%
04.01.06	SALIDAS DE FUERZA																
04.01.06.01	SALIDA SENSOR DE NIVEL DE AGUA	pto	2.00	126.42	252.84	1.0000	126.42	50.00%	0.00	0.00	0.00%	1.0000	126.42	50.00%	1.0000	126.42	50.00%
04.01.06.02	SALIDA DE FUERZA TRIFASICA	pto	20.00	80.84	1,616.80	11.0000	889.24	55.00%	0.00	0.00	0.00%	11.0000	889.24	55.00%	9.0000	727.56	45.00%
04.01.06.03	SALIDA DE FUERZA MONOFASICA	pto	14.00	80.84	1,131.76	14.0000	1,131.76	100.00%	0.00	0.00	0.00%	14.0000	1,131.76	100.00%	0.0000	0.00	0.00%
04.01.06.04	SALIDA PARA TERMA ELECTRICA	pto	4.00	265.17	1,060.68	4.0000	1,060.68	100.00%	0.00	0.00	0.00%	4.0000	1,060.68	100.00%	0.0000	0.00	0.00%
04.01.06.05	SALIDA PARA EXTRACTOR DE COCINA	pto	3.00	267.69	803.07	2.0000	535.38	66.67%	0.00	0.00	0.00%	2.0000	535.38	66.67%	1.0000	267.69	33.33%
04.01.07	SALIDA DE DATA Y TELEFONIA																
04.01.07.01	SALIDA PARA TELEFONIA	pto	11.00	27.50	302.50	6.0000	165.00	54.55%	0.00	0.00	0.00%	6.0000	165.00	54.55%	5.0000	137.50	45.45%
04.01.07.02	SALIDA PARA RED DE COMPUTO	pto	11.00	27.87	306.57	6.0000	167.22	54.55%	0.00	0.00	0.00%	6.0000	167.22	54.55%	5.0000	139.35	45.45%
04.01.08	SISTEMA DE ALARMA CONTRA INCENDIO																
04.01.08.01	SALIDA PARA CENTRAL DE ALARMA CONTRA INCENDIO	pto	4.00	333.00	1,332.00	4.0000	1,332.00	100.00%	0.00	0.00	0.00%	4.0000	1,332.00	100.00%	0.0000	0.00	0.00%
04.01.08.02	SALIDA PARA SENSOR DE HUMO	pto	14.00	100.02	1,400.28	12.0000	1,200.24	85.71%	0.00	0.00	0.00%	12.0000	1,200.24	85.71%	2.0000	200.04	14.29%
04.01.09	TUBERIA DE PVC																
04.01.09.01	TUBERIA PVC-SAP (ELECTRICA) D= 20mm	m	1,512.00	8.86	13,396.32	883.2800	7,825.86	58.42%	0.00	0.00	0.00%	883.2800	7,825.86	58.42%	628.7200	5,570.46	41.58%
04.01.09.02	TUBERIA PVC-SAP (ELECTRICA) D=25mm	m	80.00	9.96	796.80	82.5000	821.70	103.13%	0.00	0.00	0.00%	82.5000	821.70	103.13%	0.0000	0.00	0.00%
04.01.09.03	TUBERIA PVC-SAP (ELECTRICA) D=30 mm	m	782.00	11.06	8,648.92	0.0000	0.00	0.00%	0.00	0.00	0.00%	0.0000	0.00	0.00%	782.0000	8,648.92	100.00%
04.01.09.04	TUBERIA PVC-SAP (ELECTRICA) D=50mm	m	317.00	11.06	3,506.02	60.0400	664.04	18.94%	0.00	0.00	0.00%	60.0400	664.04	18.94%	256.9600	2,841.98	81.06%
04.01.09.05	TUBERIA PVC-SAP (ELECTRICA) D=80mm	m	115.00	35.34	4,064.10	115.0000	4,064.10	100.00%	0.00	0.00	0.00%	115.0000	4,064.10	100.00%	0.0000	0.00	0.00%
04.01.09.06	TUBERIA PVC-SAP (ELECTRICA) D=100mm	m	20.00	19.90	398.00	14.0000	278.60	70.00%	0.00	0.00	0.00%	14.0000	278.60	70.00%	6.0000	119.40	30.00%

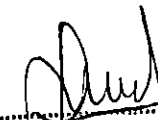
 LUDWIG CARRASCO BUSTAMANTE
 Ing. Supervisor - CIP 79040
 CESEL S.A.

OBRA: MEJORAMIENTO DE LOS SERVICIOS DEL DESEMBARCADERO PESQUERO ARTESANAL DE SUPE, REGION LIMA, PROVINCIA DE BARRANCA, DISTRITO DE SUPE PUERTO
SUB PRES: OBRAS EN TIERRA - INSTALACIONES ELECTRICAS
PROP: FONDEPES
CONT: CONSORCIO MARITIMO DEL NORTE
SUP: CESEL

FECHA: sáb 02 Mar 2019

ITEM	DESCRIPCION	PRESUPUESTO			VAL. ACUM. ANTERIOR			VAL ACTUAL			VAL ACUM. ACTUAL			SALDOS			
		Und.	Metrado	Precio (S/.)	Parcial (S/.)	Metrado	Parcial (S/.)	%	Metrado	Parcial (S/.)	%	Metrado	Parcial (S/.)	%	Metrado	Parcial (S/.)	%
04.01.10	CABLES Y CONDUCTORES																
04.01.10.01	CONDUCTOR 2X2.5mm2 NHX-90 + 1X2.5mm2 NHX-90,	m	690.00	5.77	3,981.30	0.0000	0.00	0.00%	0.00	0.00	0.00%	0.0000	0.00	0.00%	690.0000	3,981.30	100.00%
04.01.10.02	CONDUCTOR 2X4mm2 NHX-90 + 1X4mm2 NHX-90,	m	469.00	6.37	2,987.53	0.0000	0.00	0.00%	0.00	0.00	0.00%	0.0000	0.00	0.00%	469.0000	2,987.53	100.00%
04.01.10.03	CONDUCTOR 2X6mm2 NHX-90 + 1X6mm2 NHX-90,	m	42.00	8.41	353.22	0.0000	0.00	0.00%	0.00	0.00	0.00%	0.0000	0.00	0.00%	42.0000	353.22	100.00%
04.01.10.04	CONDUCTOR 4-1X4mm2 NHX-90 + 1X4mm2 NHX-90,	m	32.00	10.21	326.72	0.0000	0.00	0.00%	0.00	0.00	0.00%	0.0000	0.00	0.00%	32.0000	326.72	100.00%
04.01.10.05	CABLE N2XOH, 2-1X16mm2 + 1X16mm2, 0.6/1kV	m	420.00	26.46	11,113.20	0.0000	0.00	0.00%	0.00	0.00	0.00%	0.0000	0.00	0.00%	420.0000	11,113.20	100.00%
04.01.10.06	CABLE N2XOH, 2-1X6mm2 + 1X16mm2, 0.6/1kV	m	390.00	12.45	4,855.50	0.0000	0.00	0.00%	0.00	0.00	0.00%	0.0000	0.00	0.00%	390.0000	4,855.50	100.00%
04.01.10.07	CABLE N2XOH, 4-1X185mm2, 0.6/1kV	m	30.00	334.27	10,028.10	0.0000	0.00	0.00%	0.00	0.00	0.00%	0.0000	0.00	0.00%	30.0000	10,028.10	100.00%
04.01.10.08	CABLE N2XOH, 4-1X70mm2, 0.6/1kV	m	115.00	107.07	12,313.05	0.0000	0.00	0.00%	0.00	0.00	0.00%	0.0000	0.00	0.00%	115.0000	12,313.05	100.00%
04.01.10.09	CABLE N2XOH, 4-1X25mm2, 0.6/1kV	m	137.00	55.95	7,665.15	0.0000	0.00	0.00%	0.00	0.00	0.00%	0.0000	0.00	0.00%	137.0000	7,665.15	100.00%
04.01.10.10	CABLE N2XOH, 4-1X16mm2, 0.6/1kV	m	176.00	34.23	6,024.48	0.0000	0.00	0.00%	0.00	0.00	0.00%	0.0000	0.00	0.00%	176.0000	6,024.48	100.00%
04.01.10.11	CABLE N2XOH, 4-1X10mm2, 0.6/1kV	m	15.00	21.87	328.05	0.0000	0.00	0.00%	0.00	0.00	0.00%	0.0000	0.00	0.00%	15.0000	328.05	100.00%
04.01.10.12	CABLE N2XOH, 4-1X6mm2, 0.6/1kV	m	315.00	15.63	4,923.45	0.0000	0.00	0.00%	0.00	0.00	0.00%	0.0000	0.00	0.00%	315.0000	4,923.45	100.00%
04.01.11	TABLEROS E INTERRUPTORES																
04.01.11.01	TABLERO GENERAL TG	und	1.00	3,876.94	3,876.94	0.0000	0.00	0.00%	0.00	0.00	0.00%	0.0000	0.00	0.00%	1.0000	3,876.94	100.00%
04.01.11.02	TABLERO DE DISTRIBUCION TD-01	und	1.00	1,666.09	1,666.09	0.0000	0.00	0.00%	0.00	0.00	0.00%	0.0000	0.00	0.00%	1.0000	1,666.09	100.00%
04.01.11.03	TABLERO DE DISTRIBUCION TD-02	und	1.00	1,577.96	1,577.96	0.0000	0.00	0.00%	0.00	0.00	0.00%	0.0000	0.00	0.00%	1.0000	1,577.96	100.00%
04.01.11.04	TABLERO DE DISTRIBUCION TD-03	und	1.00	1,571.51	1,571.51	0.0000	0.00	0.00%	0.00	0.00	0.00%	0.0000	0.00	0.00%	1.0000	1,571.51	100.00%
04.01.11.05	TABLERO DE DISTRIBUCION TD-04	und	1.00	1,949.17	1,949.17	0.0000	0.00	0.00%	0.00	0.00	0.00%	0.0000	0.00	0.00%	1.0000	1,949.17	100.00%
04.01.11.06	TABLERO DE DISTRIBUCION TD-05	und	1.00	1,670.00	1,670.00	0.0000	0.00	0.00%	0.00	0.00	0.00%	0.0000	0.00	0.00%	1.0000	1,670.00	100.00%
04.01.11.07	TABLERO DE DISTRIBUCION STD-01	und	1.00	1,572.80	1,572.80	0.0000	0.00	0.00%	0.00	0.00	0.00%	0.0000	0.00	0.00%	1.0000	1,572.80	100.00%
04.01.11.08	TABLERO DE DISTRIBUCION STD-02	und	1.00	1,421.23	1,421.23	0.0000	0.00	0.00%	0.00	0.00	0.00%	0.0000	0.00	0.00%	1.0000	1,421.23	100.00%
04.01.11.09	TABLERO DE DISTRIBUCION STD-03	und	1.00	1,359.99	1,359.99	0.0000	0.00	0.00%	0.00	0.00	0.00%	0.0000	0.00	0.00%	1.0000	1,359.99	100.00%
04.01.11.10	TABLERO DE DISTRIBUCION STD-04	und	1.00	1,417.46	1,417.46	0.0000	0.00	0.00%	0.00	0.00	0.00%	0.0000	0.00	0.00%	1.0000	1,417.46	100.00%
04.01.11.11	TABLERO DE DISTRIBUCION STD-05	und	1.00	1,446.48	1,446.48	0.0000	0.00	0.00%	0.00	0.00	0.00%	0.0000	0.00	0.00%	1.0000	1,446.48	100.00%
04.01.11.12	TABLERO DE DISTRIBUCION STD-06	und	1.00	1,410.09	1,410.09	0.0000	0.00	0.00%	0.00	0.00	0.00%	0.0000	0.00	0.00%	1.0000	1,410.09	100.00%
04.01.11.13	TABLERO DE DISTRIBUCION TF-01	und	1.00	1,465.63	1,465.63	0.0000	0.00	0.00%	0.00	0.00	0.00%	0.0000	0.00	0.00%	1.0000	1,465.63	100.00%
04.01.11.14	TABLERO DE DISTRIBUCION TF-02	und	1.00	1,588.50	1,588.50	0.0000	0.00	0.00%	0.00	0.00	0.00%	0.0000	0.00	0.00%	1.0000	1,588.50	100.00%
04.01.11.15	TABLERO DE DISTRIBUCION TF-03	und	1.00	1,607.03	1,607.03	0.0000	0.00	0.00%	0.00	0.00	0.00%	0.0000	0.00	0.00%	1.0000	1,607.03	100.00%
04.01.11.16	TABLERO DE DISTRIBUCION TF-04	und	1.00	1,473.42	1,473.42	0.0000	0.00	0.00%	0.00	0.00	0.00%	0.0000	0.00	0.00%	1.0000	1,473.42	100.00%
04.01.12	PUESTA EN MARCHA																
04.01.12.01	PRUEBAS DE AISLAMIENTO Y MEDICIÓN DE RESISTENCIA	und	2.00	1,028.69	2,057.38	0.0000	0.00	0.00%	0.00	0.00	0.00%	0.0000	0.00	0.00%	2.0000	2,057.38	100.00%
04.01.12.02	PUESTA EN SERVICIO DEL SISTEMA	und	2.00	356.90	713.80	0.0000	0.00	0.00%	0.00	0.00	0.00%	0.0000	0.00	0.00%	2.0000	713.80	100.00%
04.01.12.03	CAPACITACION TECNICA EN USO Y MANTENIMIENTO	und	2.00	930.23	1,860.46	0.0000	0.00	0.00%	0.00	0.00	0.00%	0.0000	0.00	0.00%	2.0000	1,860.46	100.00%
04.01.13	PUESTA A TIERRA																
04.01.13.01	POZO DE PUESTA A TIERRA	und	5.00	671.92	3,359.60	0.0000	0.00	0.00%	0.00	0.00	0.00%	0.0000	0.00	0.00%	5.0000	3,359.60	100.00%
04.01.13.02	CONDUCTOR DE CU. DESNUDO 25 mm2.	m	120.00	12.26	1,471.20	0.0000	0.00	0.00%	0.00	0.00	0.00%	0.0000	0.00	0.00%	120.0000	1,471.20	100.00%
04.01.14	CAJAS																
04.01.14.01	CAJA DE PASE CUADRADA DE 100 x 100 x 55mm	und	22.00	32.06	705.32	22.0000	705.32	100.00%	0.00	0.00	0.00%	22.0000	705.32	100.00%	0.0000	0.00	0.00%
04.01.14.02	CAJA DE PASE CUADRADA DE 100 x 100 x 100mm	und	14.00	32.06	448.84	0.0000	0.00	0.00%	0.00	0.00	0.00%	0.0000	0.00	0.00%	14.0000	448.84	100.00%
04.01.14.03	CAJA DE PASE CUADRADA DE 200 x 200 x 150mm	und	4.00	32.06	128.24	0.0000	0.00	0.00%	0.00	0.00	0.00%	0.0000	0.00	0.00%	4.0000	128.24	100.00%
04.01.14.04	CAJA DE PASE CUADRADA DE 350 x 350 x 150mm	und	10.00	32.06	320.60	0.0000	0.00	0.00%	0.00	0.00	0.00%	0.0000	0.00	0.00%	10.0000	320.60	100.00%
04.01.14.05	CAJA DE PASE HERMETICA CON TAPA Y CON	und	23.00	37.55	863.65	0.0000	0.00	0.00%	0.00	0.00	0.00%	0.0000	0.00	0.00%	23.0000	863.65	100.00%
04.01.14.06	BUZON DE CONCRETO DE 0.60 X 0.60 X 0.70m	und	8.00	141.79	1,134.32	0.0000	0.00	0.00%	0.00	0.00	0.00%	0.0000	0.00	0.00%	8.0000	1,134.32	100.00%

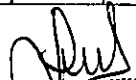
LUDWIG CARRASCO BUSTAMANTE
Ing. Supervisor - CIP 79040
CESEL S.A.

OBRA: MEJORAMIENTO DE LOS SERVICIOS DEL DESEMBARCADERO PESQUERO ARTESANAL DE SUPE, REGION LIMA, PROVINCIA DE BARRANCA, DISTRITO DE SUPE PUERTO
 SUB PRES OBRAS EN TIERRA - INSTALACIONES ELECTRICAS
 PROP. FONDEPES
 CONT. CONSORCIO MARITIMO DEL NORTE
 SUP. CESEL

FECHA: sáb 02 Mar 2019

ITEM	DESCRIPCION	PRESUPUESTO			VAL. ACUM. ANTERIOR			VAL. ACTUAL			VAL. ACUM. ACTUAL			SALDOS			
		Und.	Metrado	Precio (\$/.)	Parcial (\$/.)	Metrado	Parcial (\$/.)	%	Metrado	Parcial (\$/.)	%	Metrado	Parcial (\$/.)	%	Metrado	Parcial (\$/.)	%
04.01.15	ALUMBRADO EXTERIOR																
04.01.15.01	POSTE METÁLICO DE FºGº 4" DE 8m DE LONG.	und	23.00	599.38	13,785.74	0.0000	0.00	0.00%	0.00	0.00	0.00%	0.0000	0.00	0.00%	23.0000	13,785.74	100.00%
04.01.15.02	PASTORAL DE FºGº DE 1.20m PARTA LUMINARIA	und	23.00	169.35	3,895.05	0.0000	0.00	0.00%	0.00	0.00	0.00%	0.0000	0.00	0.00%	23.0000	3,895.05	100.00%
04.01.15.03	LUMINARIA DE VAPOR DE SODIO DE 150 W INC. EQUIPO	und	23.00	141.96	3,265.08	0.0000	0.00	0.00%	0.00	0.00	0.00%	0.0000	0.00	0.00%	23.0000	3,265.08	100.00%
04.01.16	EQUIPOS DE ILUMINACION																
04.01.16.01	ARTEFACTO REFLECTOR 1 X 250W	und	14.00	603.01	8,442.14	0.0000	0.00	0.00%	0.00	0.00	0.00%	0.0000	0.00	0.00%	14.0000	8,442.14	100.00%
04.01.16.02	ARTEFACTO FLUORESCENTE HERMETICO DE 2x36 W	und	60.00	140.74	8,444.40	0.0000	0.00	0.00%	0.00	0.00	0.00%	0.0000	0.00	0.00%	60.0000	8,444.40	100.00%
04.01.16.03	ARTEFACTO FLUORESCENTE LINEAL DE 2x36 W	und	121.00	137.36	16,620.56	0.0000	0.00	0.00%	0.00	0.00	0.00%	0.0000	0.00	0.00%	121.0000	16,620.56	100.00%
04.01.16.04	ARTEFACTO FLUORESCENTE HERMETICO DE 2x18 W	und	10.00	115.49	1,154.90	0.0000	0.00	0.00%	0.00	0.00	0.00%	0.0000	0.00	0.00%	10.0000	1,154.90	100.00%
04.01.16.05	ARTEFACTO FLUORESCENTE CIRCULAR HERMETICO 22W	und	28.00	80.60	2,256.80	0.0000	0.00	0.00%	0.00	0.00	0.00%	0.0000	0.00	0.00%	28.0000	2,256.80	100.00%
04.01.16.06	ARTEFACTO TIPO BRAQUET DE 1 X 32W	und	11.00	195.34	2,148.74	0.0000	0.00	0.00%	0.00	0.00	0.00%	0.0000	0.00	0.00%	11.0000	2,148.74	100.00%
04.01.16.07	LUMINARIA DE EMERGENCIA COMPACTA C/BATERIA	und	29.00	128.40	3,723.60	0.0000	0.00	0.00%	0.00	0.00	0.00%	0.0000	0.00	0.00%	29.0000	3,723.60	100.00%
04.01.17	GRUPO ELECTROGENO 150 KVA (INCLUYE TANQUE DE																
04.01.17.01	GRUPO ELECTROGENO DE 150 KVA, 380-220V TRIFASICO,	und	1.00	50,355.98	50,355.98	0.0000	0.00	0.00%	0.00	0.00	0.00%	0.0000	0.00	0.00%	1.0000	50,355.98	100.00%
04.01.17.02	TABLERO DE TRANSFERENCIA AUTOMATICO	und	1.00	10,262.28	10,262.28	0.0000	0.00	0.00%	0.00	0.00	0.00%	0.0000	0.00	0.00%	1.0000	10,262.28	100.00%
04.02	MEDIA TENSION																
04.02.01	OBRAS PRELIMINARES																
04.02.01.01	FRANJA DE SERVIDUMBRE	und	1.00	3,488.35	3,488.35	0.0000	0.00	0.00%	0.00	0.00	0.00%	0.0000	0.00	0.00%	1.0000	3,488.35	100.00%
04.02.01.02	REPLANTEO TOPOGRAFICO	km	0.30	458.76	137.63	0.0000	0.00	0.00%	0.00	0.00	0.00%	0.0000	0.00	0.00%	0.3000	137.63	100.00%
04.02.02	MOVIMIENTO DE TIERRAS																
04.02.02.01	EXCAVACION DE ZANJA DE 0.70 X 1.00m EN TERRENO NATURAL	m3	6.00	114.13	684.78	0.0000	0.00	0.00%	0.00	0.00	0.00%	0.0000	0.00	0.00%	6.0000	684.78	100.00%
04.02.02.02	EXCAVACION DE ZANJA PARA BUZONES DE 1.00 X 1.00m EH	m3	4.00	80.56	322.24	0.0000	0.00	0.00%	0.00	0.00	0.00%	0.0000	0.00	0.00%	4.0000	322.24	100.00%
04.02.02.03	RELLENO COMPACTADO CON MATERIAL PROPIO SELECCIONADO	m3	4.00	54.54	218.16	0.0000	0.00	0.00%	0.00	0.00	0.00%	0.0000	0.00	0.00%	4.0000	218.16	100.00%
04.02.03	CONDUCTOS Y CANALIZACIONES																
04.02.03.01	DUCTO DE CONCRETO 4 VIAS X 1m X 0.90 DIAMETRO	und	6.00	195.80	1,174.80	0.0000	0.00	0.00%	0.00	0.00	0.00%	0.0000	0.00	0.00%	6.0000	1,174.80	100.00%
04.02.03.02	BUZON DE CONCRETO PREFABRICADO DE 1.00 X 1.00 X 1.20m	und	2.00	80.56	161.12	0.0000	0.00	0.00%	0.00	0.00	0.00%	0.0000	0.00	0.00%	2.0000	161.12	100.00%
04.02.03.03	TUBERIA DE FIERRO GALVANIZADO 4" P/INSTALACIONES	m	6.00	318.04	1,908.24	0.0000	0.00	0.00%	0.00	0.00	0.00%	0.0000	0.00	0.00%	6.0000	1,908.24	100.00%
04.02.03.04	TUBERIA PVC SAP (ELECTRICA) D=80mm	m	6.00	28.42	170.52	0.0000	0.00	0.00%	0.00	0.00	0.00%	0.0000	0.00	0.00%	6.0000	170.52	100.00%
04.02.04	MONTAJE DE POSTES DE CONCRETO																
04.02.04.01	EXCAVACION DE TERRENO ROCOSO PARA POSTES	und	1.00	413.27	413.27	0.0000	0.00	0.00%	0.00	0.00	0.00%	0.0000	0.00	0.00%	1.0000	413.27	100.00%
04.02.04.02	POSTE DE C.A.C. 13/400/160/355	und	1.00	1,431.38	1,431.38	0.0000	0.00	0.00%	0.00	0.00	0.00%	0.0000	0.00	0.00%	1.0000	1,431.38	100.00%
04.02.04.03	RELLENO Y COMPACTACION PARA CIMENTACION DE POSTE	und	1.00	54.54	54.54	0.0000	0.00	0.00%	0.00	0.00	0.00%	0.0000	0.00	0.00%	1.0000	54.54	100.00%
04.02.05	MONTAJE DE ARMADOS																
04.02.05.01	ARMADO DE DERIVACION	und	1.00	1,667.34	1,667.34	0.0000	0.00	0.00%	0.00	0.00	0.00%	0.0000	0.00	0.00%	1.0000	1,667.34	100.00%
04.02.05.02	MONTAJE DE TRAFOMIX	und	1.00	13,327.54	13,327.54	0.0000	0.00	0.00%	0.00	0.00	0.00%	0.0000	0.00	0.00%	1.0000	13,327.54	100.00%
04.02.06	MONTAJE DE CONDUCTORES																
04.02.06.01	TENDIDO Y CABLEADO DE CONDUCTOR AAAC 35mm	m	35.00	2.72	95.20	0.0000	0.00	0.00%	0.00	0.00	0.00%	0.0000	0.00	0.00%	35.0000	95.20	100.00%
04.02.06.02	TENDIDO Y CABLEADO DE CONDUCTOR DE CU TIPO N2XSY,	m	30.00	59.62	1,788.60	0.0000	0.00	0.00%	0.00	0.00	0.00%	0.0000	0.00	0.00%	30.0000	1,788.60	100.00%
04.02.06.03	ACCESORIOS PARA CONDUCTOR DE COBRE N2XSY DE 35mm2	jgo	2.00	781.33	1,562.66	0.0000	0.00	0.00%	0.00	0.00	0.00%	0.0000	0.00	0.00%	2.0000	1,562.66	100.00%
04.02.07	INSTALACION DE PUESTA A TIERRA																
04.02.07.01	EXCAVACION DE HUECO PARA POZO A TIERRA EN TERRENO	m3	4.00	69.96	279.84	0.0000	0.00	0.00%	0.00	0.00	0.00%	0.0000	0.00	0.00%	4.0000	279.84	100.00%
04.02.07.02	INSTALACION DE PUESTA A TIERRA TIPO PAT-1	und	4.00	531.17	2,124.68	0.0000	0.00	0.00%	0.00	0.00	0.00%	0.0000	0.00	0.00%	4.0000	2,124.68	100.00%
04.02.07.03	RELLENO Y COMPACTACION DE PUESTA A TIERRA	m3	4.00	30.79	123.16	0.0000	0.00	0.00%	0.00	0.00	0.00%	0.0000	0.00	0.00%	4.0000	123.16	100.00%

 LUDWING CARRASCO BUSTAMANTE
 Ing. Supervisor - CIP 79040
 CESEL S.A.

OBRA: MEJORAMIENTO DE LOS SERVICIOS DEL DESEMBARCADERO PESQUERO ARTESANAL DE SUPE ,REGION LIMA, PROVINCIA DE BARRANCA, DISTRITO DE SUPE PUERTO
 SUB PRES OBRAS EN TIERRA - INSTALACIONES ELECTRICAS
 PROP. FONDEPES
 CONT. CONSORCIO MARITIMO DEL NORTE
 SUP. CESEL

FECHA: sáb 02 Mar 2019

ITEM	DESCRIPCION	PRESUPUESTO			VAL. ACUM. ANTERIOR			VAL. ACTUAL			VAL. ACUM. ACTUAL			SALDOS			
		Und.	Metrado	Precio (\$/.)	Parcial (\$/.)	Metrado	Parcial (\$/.)	%	Metrado	Parcial (\$/.)	%	Metrado	Parcial (\$/.)	%	Metrado	Parcial (\$/.)	%
04.02.08	INSTALACION DE SUBESTACION ELECTRICA																
04.02.08.01	CELDA DE LLEGADA Y MEDICION 12KV. INCLUYE EQUIPOS	und	1.00	55,762.78	55,762.78	0.0000	0.00	0.00%	0.00	0.00	0.00%	0.0000	0.00	0.00%	1.0000	55,762.78	100.00%
04.02.08.02	CELDA DE TRANSFORMACION INC. EQUIPAMIENTO	und	1.00	39,220.90	39,220.90	0.0000	0.00	0.00%	0.00	0.00	0.00%	0.0000	0.00	0.00%	1.0000	39,220.90	100.00%
04.02.08.03	MONTAJE DE TRANSFORMADOR DE 250KVA	und	1.00	75,887.86	75,887.86	0.0000	0.00	0.00%	0.00	0.00	0.00%	0.0000	0.00	0.00%	1.0000	75,887.86	100.00%
04.02.08.04	TABLERO GENERAL AUTOSOPORTADO TRIFASICO	und	1.00	8,139.52	8,139.52	0.0000	0.00	0.00%	0.00	0.00	0.00%	0.0000	0.00	0.00%	1.0000	8,139.52	100.00%
04.02.08.05	SISTEMA DE COMPENSACION REACTIVA	und	1.00	20,294.06	20,294.06	0.0000	0.00	0.00%	0.00	0.00	0.00%	0.0000	0.00	0.00%	1.0000	20,294.06	100.00%
04.02.09	INSTALACION DE SISTEMA DE MEDICION																
04.02.09.01	MURO PARA PUNTO DE MEDICION EN MEDIA TENSION	m2	1.00	177.24	177.24	0.0000	0.00	0.00%	0.00	0.00	0.00%	0.0000	0.00	0.00%	1.0000	177.24	100.00%
04.02.09.02	MONTAJE DE CATA PORTAMEDIDOR TRIFASICO	und	1.00	1,905.14	1,905.14	0.0000	0.00	0.00%	0.00	0.00	0.00%	0.0000	0.00	0.00%	1.0000	1,905.14	100.00%
04.02.10	PRUEBAS Y PUESTA EN SERVICIO																
04.02.10.01	PRUEBAS Y PUESTA EN SERVICIO DE RED PRIMARIA Y	und	2.00	536.71	1,073.42	0.0000	0.00	0.00%	0.00	0.00	0.00%	0.0000	0.00	0.00%	2.0000	1,073.42	100.00%
04.02.10.02	CONEXION ELECTRICA	est	1.00	1,944.00	1,944.00	0.0000	0.00	0.00%	0.00	0.00	0.00%	0.0000	0.00	0.00%	1.0000	1,944.00	100.00%
	COSTO DIRECTO				533,471.71		28,931.89		0.00	0.00%		28,931.89	5.42%		504,564.72	94.58%	
	GASTOS GENERALES			20.083931%	107,142.09		5,810.66		0.00		5,810.66						
	UTILIDAD		2.32247829%		12,389.77		671.94		0.00		671.94						
	SUB TOTAL				653,003.57		35,414.48		0.00		35,414.48				516,283.13		
	IGV 18%		18.06%		117,540.64		6,374.61		0.00		6,374.61				92,930.96		
	PRESUPUESTO TOTAL				770,544.21		41,789.09		0.00		41,789.09				609,214.10		

 LUDWING CARRASCO BUSTAMANTE
 Ing. Supervisor - CIP 79040
 CESEL S.A.

870000

OBRA: MEJORAMIENTO DE LOS SERVICIOS DEL DESEMBARCADERO PESQUERO ARTESANAL DE SUPE ,REGION LIMA, PROVINCIA DE BARRANCA, DISTRITO DE SUPE PUERTO
 SUB PROY. INSTALACIONES SANITARIAS
 PROP. FONDEPES
 CONT. CONSORCIO MARITIMO DEL NORTE
 SUP. CESEL

FECHA: mar 02 Oct 2018

ITEM	DESCRIPCION	PRESUPUESTO			VAL. ACUM. ANTERIOR			VAL. ACTUAL			VAL. ACUM. ACTUAL			SALDOS			
		Und.	Metrado	Precio (S/.)	Parcial (S/.)	Metrado	Parcial (S/.)	%	Metrado	Parcial (S/.)	%	Metrado	Parcial (S/.)	%	Metrado	Parcial (S/.)	%
05	INSTALACIONES SANITARIAS																
05.01	RED DE AGUA POTABLE																
05.01.01	RED DE DISTRIBUCION																
05.01.01.01	TRAZO Y REPLANTEO DE RED	m	658.40	3.64	2,396.58	130.4600	S/ 474.87	19.81%	0.00	S/ -	0.00%	130.4600	S/ 474.87	19.81%	527.9400	1,921.71	80.19%
05.01.01.02	EXCAVACION DE ZANJA P/TUBERIA	m	642.40	35.88	23,049.31	62.7100	S/ 2,250.03	9.76%	0.00	S/ -	0.00%	62.7100	S/ 2,250.03	9.76%	579.6900	20,799.28	90.24%
05.01.01.03	REFINE Y NIVELACION DE ZANJAS	m	642.40	5.26	3,379.02	82.5600	S/ 434.27	12.85%	0.00	S/ -	0.00%	82.5600	S/ 434.27	12.85%	559.8400	2,944.75	87.15%
05.01.01.04	PREP. D/CAMA DE APOYO (E=10cm)	m	642.40	20.70	13,297.68	82.5600	S/ 1,708.99	12.85%	0.00	S/ -	0.00%	82.5600	S/ 1,708.99	12.85%	559.8400	11,588.69	87.15%
05.01.01.05	RELL. COMP. C.PL VIBRADOR/MANUAL E/T. N	m	642.40	16.30	10,471.12	87.1900	S/ 1,421.20	13.57%	0.00	S/ -	0.00%	87.1900	S/ 1,421.20	13.57%	555.2100	9,049.92	86.43%
05.01.02	SALIDAS																
05.01.02.01	SALIDA DE AGUA FRIA CON TUBERIA PVC SAP 1/2"	plg	71.00	87.23	6,193.33	71.0000	S/ 6,193.33	100.00%	0.00	S/ -	0.00%	71.0000	S/ 6,193.33	100.00%	0.0000	0.00	0.00%
05.01.02.02	SALIDA DE AGUA FRIA CON TUBERIA PVC SAP 3/4"	plg	8.00	94.42	755.36	0.0000	S/ -	0.00%	0.00	S/ -	0.00%	0.0000	S/ -	0.00%	8.0000	755.36	100.00%
05.01.03	VALVULAS																
05.01.03.01	VALVULA COMPUERTA DE BRONCE DE UNION ROSCADA	und	18.00	46.70	840.60	0.0000	S/ -	0.00%	0.00	S/ -	0.00%	0.0000	S/ -	0.00%	18.0000	840.60	100.00%
05.01.04	TUBERIAS																
05.01.04.01	SUM. /INST. T/PRUEBA HIDRA/TUB PVC D=1/2" C-5	m	174.65	13.36	2,333.32	0.0000	S/ -	0.00%	0.00	S/ -	0.00%	0.0000	S/ -	0.00%	174.6500	2,333.32	100.00%
05.01.04.02	SUM. /INST. T/PRUEBA HIDRA/TUB PVC D=3/4" C-5	m	145.05	16.33	2,368.67	0.0000	S/ -	0.00%	0.00	S/ -	0.00%	0.0000	S/ -	0.00%	145.0500	2,368.67	100.00%
05.01.04.03	SUM. /INST. T/PRUEBA HIDRA/TUB PVC D=1" C-5	m	13.85	20.55	284.62	0.0000	S/ -	0.00%	0.00	S/ -	0.00%	0.0000	S/ -	0.00%	13.8500	284.62	100.00%
05.01.04.04	SUM. /INST. T/PRUEBA HIDRA/TUB PVC D=1 1/2" C-5	m	95.85	22.09	2,117.33	0.0000	S/ -	0.00%	0.00	S/ -	0.00%	0.0000	S/ -	0.00%	95.8500	2,117.33	100.00%
05.01.04.05	SUM. /INST. T/PRUEBA HIDRA/TUB PVC D=2" C-5	m	88.00	22.14	1,948.32	0.0000	S/ -	0.00%	0.00	S/ -	0.00%	0.0000	S/ -	0.00%	88.0000	1,948.32	100.00%
05.01.05	VIARIOS																
05.01.05.01	NICHO Y TAPA DE MADERA PARA VALVULA EN PARED	und	18.00	60.20	1,083.60	0.0000	S/ -	0.00%	3.0000	S/ 180.60	16.67%	3.0000	S/ 180.60	16.67%	15.0000	903.00	83.33%
05.01.06	ACCESORIOS																
05.01.06.01	VALVULA Y ACCESORIOS PARA CISTERNA Y TANQUE ELEVADO	und	2.00	1,224.52	2,449.04	0.0000	S/ -	0.00%	0.00	S/ -	0.00%	0.0000	S/ -	0.00%	2.0000	2,449.04	100.00%
05.01.07	PRUEBA HIDRAULICA																
05.01.07.01	PRUEBA HIDRAULICA PARA TUBERIA DE AGUA FRIA	m	562.00	6.86	3,855.32	107.4800	S/ 737.31	19.12%	0.00	S/ -	0.00%	107.4800	S/ 737.31	19.12%	454.5200	3,118.01	80.88%
05.01.08	EQUIPO DE BOMBEO																
05.01.08.01	ADQUISICION /INST. /02 ELECTROBOMBAS	und	2.00	4,431.81	8,863.62	0.0000	S/ -	0.00%	0.00	S/ -	0.00%	0.0000	S/ -	0.00%	2.0000	8,863.62	100.00%
05.01.08.02	ACCESORIOS PARA CASETA T/ELEVADO	und	1.00	1,076.21	1,076.21	0.0000	S/ -	0.00%	0.00	S/ -	0.00%	0.0000	S/ -	0.00%	1.0000	1,076.21	100.00%
05.01.08.03	ACCESORIOS PARA LA BOMBA	und	2.00	1,385.84	2,771.68	0.0000	S/ -	0.00%	0.00	S/ -	0.00%	0.0000	S/ -	0.00%	2.0000	2,771.68	100.00%
05.01.09	LINEA DE IMPULSION																
05.01.09.01	TUBERIA FIERRO GALVANIZADO AGUA FRIA D=2"	m	32.75	60.81	1,991.53	0.0000	S/ -	0.00%	0.00	S/ -	0.00%	0.0000	S/ -	0.00%	32.7500	1,991.53	100.00%
05.01.10	PUESTA A SERVICIO																
05.01.10.01	CONEXION DE AGUA POTABLE	est	1.00	1,296.00	1,296.00	0.0000	S/ -	0.00%	0.00	S/ -	0.00%	0.0000	S/ -	0.00%	1.0000	1,296.00	100.00%

 LUDWING CARRASCO BUSTAMANTE
 Ing. Supervisor - CIP 79040
 CESEL S.A.

000017



VALORIZACIÓN 17 - ENERO 2019 - INSTALACIONES SANITARIAS

Contrato N° 025-2017- FONDEPES Ejecución de la Obra: MEJORAMIENTO DE LOS SERVICIOS DEL DESEMBARCADERO PESQUERO ARTESANAL DE SUPE, REGION LIMA, PROVINCIA DE BARRANCA, DISTRITO DE SUPE PUERTO



OBRA: MEJORAMIENTO DE LOS SERVICIOS DEL DESEMBARCADERO PESQUERO ARTESANAL DE SUPE, REGION LIMA, PROVINCIA DE BARRANCA, DISTRITO DE SUPE PUERTO
 SUB PRES: INSTALACIONES SANITARIAS
 PROP: FONDEPES
 CONT: CONSORCIO MARITIMO DEL NORTE
 SUP: CESEL

FECHA: mar 02 Oct 2018

ITEM	DESCRIPCION	PRESUPUESTO			VAL. ACUM. ANTERIOR			VAL. ACTUAL			VAL. ACUM. ACTUAL			SALDOS			
		Und.	Metrado	Precio (S/.)	Parcial (S/.)	Metrado	Parcial (S/.)	%	Metrado	Parcial (S/.)	%	Metrado	Parcial (S/.)	%	Metrado	Parcial (S/.)	%
05.02	RED DE ALCANTARILLADO																
05.02.01	SANEAMIENTO																
05.02.01.01	EXCAVACION DE ZANJA P/TUBERIA	m	55.54	35.88	1,992.78	55.5400	S/ 1,992.78	100.00%	0.00	S/ -	0.00%	55.5400	S/ 1,992.78	100.00%	0.0000	0.00%	100.00%
05.02.01.02	REFINE Y NIVELACION DE ZANJAS	m	55.54	5.26	292.14	55.5400	S/ 292.14	100.00%	0.00	S/ -	0.00%	55.5400	S/ 292.14	100.00%	0.0000	0.00%	100.00%
05.02.01.03	PREP. D/CAMA DE APOYO (E=10cm)	m	55.54	20.70	1,149.68	55.5400	S/ 1,149.68	100.00%	0.00	S/ -	0.00%	55.5400	S/ 1,149.68	100.00%	0.0000	0.00%	100.00%
05.02.01.04	RELL. COMP. C.PL VIBRADOR/MANUAL E/T, N	m	55.54	16.30	905.30	55.5400	S/ 905.30	100.00%	0.00	S/ -	0.00%	55.5400	S/ 905.30	100.00%	0.0000	0.00%	100.00%
05.02.01.05	ELIMINACION DE MATERIAL EXCEDENTE EXCAV. ZANJAS	m3	15.33	12.99	199.14	15.3300	S/ 199.14	100.00%	0.00	S/ -	0.00%	15.3300	S/ 199.14	100.00%	0.0000	0.00%	100.00%
05.02.02	CAJA DE REGISTRO																
05.02.02.01	CAJA DE REGISTRO DE 12"X24"	und	15.00	216.35	3,245.25	6.0000	S/ 1,298.10	40.00%	0.00	S/ -	0.00%	6.0000	S/ 1,298.10	40.00%	9.0000	1,947.15	60.00%
05.02.02.02	CAJA DE REGISTRO DE 24"X24"	und	1.00	263.77	263.77	0.0000	S/ -	0.00%	0.00	S/ -	0.00%	0.0000	S/ -	0.00%	1.0000	263.77	100.00%
05.02.03	BUZONES DE INSPECCION																
05.02.03.01	CONSTRUCCION DE BUZON H=1.50m	und	1.00	2,146.96	2,146.96	0.0000	S/ -	0.00%	0.00	S/ -	0.00%	0.0000	S/ -	0.00%	1.0000	2,146.96	100.00%
05.02.04	TUBERIAS																
05.02.04.01	INSTALACION DE TUBERIA PVC SAL D=2"	m	169.65	7.01	1,189.25	0.0000	S/ -	0.00%	0.00	S/ -	0.00%	0.0000	S/ -	0.00%	169.6500	1,189.25	100.00%
05.02.04.02	INSTALACION DE TUBERIA PVC SAL D=4"	m	115.05	11.40	1,311.57	0.0000	S/ -	0.00%	0.00	S/ -	0.00%	0.0000	S/ -	0.00%	115.0500	1,311.57	100.00%
05.02.04.03	INSTALACION DE VENTILACION PVC D=6"	m	150.15	29.75	4,466.96	0.0000	S/ -	0.00%	0.00	S/ -	0.00%	0.0000	S/ -	0.00%	150.1500	4,466.96	100.00%
05.02.05	SALIDAS DE DESAGUE Y VENTILACION																
05.02.05.01	SALIDA DE DESAGUE PVC SAL 2"	pie	57.00	16.54	942.78	52.0000	S/ 860.08	91.23%	0.00	S/ -	0.00%	52.0000	S/ 860.08	91.23%	5.0000	82.70	8.77%
05.02.05.02	SALIDA DE DESAGUE PVC SAL 4"	pie	17.00	22.27	378.59	17.0000	S/ 378.59	100.00%	0.00	S/ -	0.00%	17.0000	S/ 378.59	100.00%	0.0000	0.00	0.00%
05.02.05.03	SALIDA DE VENTILACION PVC SAL D=2"	pie	6.00	64.64	387.84	6.0000	S/ 387.84	100.00%	0.00	S/ -	0.00%	6.0000	S/ 387.84	100.00%	0.0000	0.00	0.00%
05.02.05.04	SALIDA DE BAJADA DE LLUVIA PVC SAL D=3"	pie	15.00	86.33	1,294.95	0.0000	S/ -	0.00%	0.00	S/ -	0.00%	0.0000	S/ -	0.00%	15.0000	1,294.95	100.00%
05.02.06	ADITAMENTOS VARIOS																
05.02.06.01	ACCESORIOS PARA DESAGUE	und	1.00	965.86	965.86	0.5000	S/ 482.93	50.00%	0.00	S/ -	0.00%	0.5000	S/ 482.93	50.00%	0.5000	482.93	50.00%
05.02.07	REGISTROS																
05.02.07.01	REGISTRO DE BRONCE DE 2"	und	2.00	41.17	82.34	2.0000	S/ 82.34	100.00%	0.00	S/ -	0.00%	2.0000	S/ 82.34	100.00%	0.0000	0.00	0.00%
05.02.07.02	REGISTRO DE BRONCE DE 4"	und	22.00	32.26	709.72	2.0000	S/ 64.52	9.09%	0.00	S/ -	0.00%	2.0000	S/ 64.52	9.09%	20.0000	645.20	90.91%
05.02.08	SUMINDEROS																
05.02.08.01	SUMIDERO DE 2"	und	23.00	37.67	866.41	14.0000	S/ 527.38	60.87%	0.00	S/ -	0.00%	14.0000	S/ 527.38	60.87%	9.0000	339.03	39.13%
05.02.09	CAMARA DE BOMBEO, CUARTO DE BOMBAS																
05.02.09.01	SUMINISTRO E INSTALACION DE EQUIPO DE BOMBEO	und	2.00	4,705.84	9,411.68	0.0000	S/ -	0.00%	0.00	S/ -	0.00%	0.0000	S/ -	0.00%	2.0000	9,411.68	100.00%
05.02.09.02	ACCESORIOS PARA BOMBAS SUMERGIBLES	und	1.00	1,385.84	1,385.84	0.0000	S/ -	0.00%	0.00	S/ -	0.00%	0.0000	S/ -	0.00%	1.0000	1,385.84	100.00%
05.02.09.03	ACCESORIOS PARA CASETA DE BOMBEO	und	1.00	1,164.49	1,164.49	0.0000	S/ -	0.00%	0.00	S/ -	0.00%	0.0000	S/ -	0.00%	1.0000	1,164.49	100.00%
05.02.09.04	CONSTRUCCION DE CASETA DE BOMBAS	und	1.00	8,273.24	8,273.24	0.0000	S/ -	0.00%	0.00	S/ -	0.00%	0.0000	S/ -	0.00%	1.0000	8,273.24	100.00%
05.02.10	LINEA DE IMPULSION																
05.02.10.01	SUM. /INST. T/PRUEBA HIDRA/TUB PVC D=2" C-10	m	20.00	33.76	675.20	0.0000	S/ -	0.00%	0.00	S/ -	0.00%	0.0000	S/ -	0.00%	20.0000	675.20	100.00%

LUDWING CARRASCO BUSTAMANTE
 Ing. Supervisor - CIP 79040
 CESEL S.A.

970000

OBRA: MEJORAMIENTO DE LOS SERVICIOS DEL DESEMBARCADERO PESQUERO ARTESANAL DE SUPE ,REGION LIMA, PROVINCIA DE BARRANCA, DISTRITO DE SUPE PUERTO
SUB PRES: INSTALACIONES SANITARIAS
PROP: FONDEPES
CONT: CONSORCIO MARITIMO DEL NORTE
SUP: CESEL

FECHA: mar 02 Oct 2018

ITEM	DESCRIPCION	PRESUPUESTO			VAL. ACUM. ANTERIOR			VAL. ACTUAL			VAL. ACUM. ACTUAL			SALDOS			
		Und.	Metrado	Precio (S/.)	Parcial (S/.)	Metrado	Parcial (S/.)	%	Metrado	Parcial (S/.)	%	Metrado	Parcial (S/.)	%	Metrado	Parcial (S/.)	%
05.02.11	PRUEBA DE NIVELACION																
05.02.11.01	PRUEBA DE NIVELACION P/DESAGUE	m	549.15	3.91	2,147.18	104.7000	S/ 409.38	19.07%	0.00	S/ -	0.00%	104.7000	S/ 409.38	19.07%	444.4500	1,737.80	80.93%
05.02.12	PRUEBA HIDRAULICA																
05.02.12.01	PRUEBA HIDRAULICA P/DESAGUE	m	549.15	3.91	2,147.18	137.3500	S/ 537.04	25.01%	0.00	S/ -	0.00%	137.3500	S/ 537.04	25.01%	411.8000	1,610.14	74.99%
05.02.13	TRAMPA DE GRASAS																
05.02.13.01	TRAMPA DE GRASAS Y SOLIDOS	und	1.00	1,300.18	1,300.18	0.0000	S/ -	0.00%	0.00	S/ -	0.00%	0.0000	S/ -	0.00%	1.0000	1,300.18	100.00%
05.02.14	CANALETAS																
05.02.14.01	EXCAVACION DE CANALETAS	m	204.00	35.32	7,205.28	0.0000	S/ -	0.00%	0.00	S/ -	0.00%	0.0000	S/ -	0.00%	204.0000	7,205.28	100.00%
05.02.14.02	ENCOFRADO DE CANALETAS	m2	326.40	116.10	37,895.04	0.0000	S/ -	0.00%	0.00	S/ -	0.00%	0.0000	S/ -	0.00%	326.4000	37,895.04	100.00%
05.02.14.03	CONCRETO f'c=210 kg/cm2 EN CANALETAS	m3	23.04	386.99	8,916.25	0.0000	S/ -	0.00%	0.00	S/ -	0.00%	0.0000	S/ -	0.00%	23.0400	8,916.25	100.00%
05.02.14.04	COLOCACION DE REJILLA EN CANALETAS DE FIBRA DE VIDRIO	m2	76.80	294.78	22,639.10	0.0000	S/ -	0.00%	0.00	S/ -	0.00%	0.0000	S/ -	0.00%	76.8000	22,639.10	100.00%
05.03	RED DE AGUA DE MAR																
05.03.01	CASETA DE CAPTACION																
05.03.01.01	ACCESORIOS PARA EQUIPO DE SUCCION	und	1.00	3,690.94	3,690.94	0.0000	S/ -	0.00%	0.00	S/ -	0.00%	0.0000	S/ -	0.00%	1.0000	3,690.94	100.00%
05.03.02	EQUIPO DE BOMBEO A CISTERNA																
05.03.02.01	ADQUISICION /INST. /02 ELECTROBOMBAS Q=6.5LT	und	2.00	5,305.62	10,611.24	0.0000	S/ -	0.00%	0.00	S/ -	0.00%	0.0000	S/ -	0.00%	2.0000	10,611.24	100.00%
05.03.02.02	ACCESORIOS PARA LA BOMBA	und	1.00	1,385.84	1,385.84	0.0000	S/ -	0.00%	0.00	S/ -	0.00%	0.0000	S/ -	0.00%	1.0000	1,385.84	100.00%
05.03.03	SISTEMA DE FILTRADO Y DESINFECCION																
05.03.03.01	EQUIPO DE FILTRADO Y DESINFECCION	und	2.00	5,250.48	10,500.96	0.0000	S/ -	0.00%	0.00	S/ -	0.00%	0.0000	S/ -	0.00%	2.0000	10,500.96	100.00%
05.03.03.02	ACCESORIOS PARA EL SISTEMA DE FILTRADO	und	1.00	1,978.25	1,978.25	0.0000	S/ -	0.00%	0.00	S/ -	0.00%	0.0000	S/ -	0.00%	1.0000	1,978.25	100.00%
05.03.04	LINEA DE IMPULSION A CISTERNA																
05.03.04.01	EXCAVACION DE ZANJA P/TUBERIA	m	42.25	35.88	1,515.93	7.6700	S/ 275.20	18.15%	0.00	S/ -	0.00%	7.6700	S/ 275.20	18.15%	34.5800	1,240.73	81.85%
05.03.04.02	REFINE Y NIVELACION DE ZANJAS	m	42.50	5.26	223.55	0.0000	S/ -	0.00%	0.00	S/ -	0.00%	0.0000	S/ -	0.00%	42.5000	223.55	100.00%
05.03.04.03	PREP. D/CAMA DE APOYO (E=10cm)	m	42.50	20.70	879.75	0.0000	S/ -	0.00%	0.00	S/ -	0.00%	0.0000	S/ -	0.00%	42.5000	879.75	100.00%
05.03.04.04	RELL. COMP. C.PL VIBRADOR/MANUAL E/T. N	m	42.50	16.30	692.75	4.6020	S/ 75.01	10.83%	0.00	S/ -	0.00%	4.6020	S/ 75.01	10.83%	37.8980	617.74	89.17%
05.03.04.05	SUM. /INST. T/PRUEBA HIDRA/TUB PVC D=2 1/2" C-10	m	273.98	23.30	6,383.73	0.0000	S/ -	0.00%	0.00	S/ -	0.00%	0.0000	S/ -	0.00%	273.9800	6,383.73	100.00%
05.03.04.06	TUBERIA DE FIERRO GALVANIZADO AGUA FRIA D=2"	m	33.50	60.81	2,037.14	0.0000	S/ -	0.00%	0.00	S/ -	0.00%	0.0000	S/ -	0.00%	33.5000	2,037.14	100.00%
05.03.05	RED DE DISTRIBUCION																
05.03.05.01	EXCAVACION DE ZANJA P/TUBERIA	m	270.55	35.88	9,707.33	39.8300	S/ 1,429.10	14.72%	0.00	S/ -	0.00%	39.8300	S/ 1,429.10	14.72%	230.7200	8,278.23	85.28%
05.03.05.02	REFINE Y NIVELACION DE ZANJAS	m	270.55	5.26	1,423.09	39.8300	S/ 209.51	14.72%	0.00	S/ -	0.00%	39.8300	S/ 209.51	14.72%	230.7200	1,213.58	85.28%
05.03.05.03	PREP. D/CAMA DE APOYO (E=10cm)	m	270.55	20.70	5,600.39	39.8300	S/ 824.48	14.72%	0.00	S/ -	0.00%	39.8300	S/ 824.48	14.72%	230.7200	4,775.91	85.28%
05.03.05.04	SUM. /INST. T/PRUEBA HIDRA/TUB PVC D=3/4" C-5	m	389.48	16.33	6,360.21	0.0000	S/ -	0.00%	0.00	S/ -	0.00%	0.0000	S/ -	0.00%	389.4800	6,360.21	100.00%
05.03.05.05	SUM. /INST. T/PRUEBA HIDRA/TUB PVC D=2" C-10	m	305.85	33.76	10,325.50	3.1500	S/ 106.34	1.03%	0.00	S/ -	0.00%	3.1500	S/ 106.34	1.03%	302.7000	10,219.16	98.97%
05.03.05.06	SUM. /INST. T/PRUEBA HIDRA/TUB PVC D=2" C-5	m	28.75	22.14	636.53	0.0000	S/ -	0.00%	0.00	S/ -	0.00%	0.0000	S/ -	0.00%	28.7500	636.53	100.00%
05.03.05.07	SUM. /INST. T/PRUEBA HIDRA/TUB PVC D=3" C-5	m	62.35	69.39	4,326.47	0.0000	S/ -	0.00%	0.00	S/ -	0.00%	0.0000	S/ -	0.00%	62.3500	4,326.47	100.00%
05.03.05.08	RELL. COMP. C.PL VIBRADOR/MANUAL E/T. N	m	270.55	16.30	4,409.97	0.0000	S/ -	0.00%	0.00	S/ -	0.00%	0.0000	S/ -	0.00%	270.5500	4,409.97	100.00%
05.03.05.09	SUM. /INST. T/PRUEBA HIDRA/TUB PVC D=3/4" C-5	m	27.00	34.48	930.42	0.0000	S/ -	0.00%	0.00	S/ -	0.00%	0.0000	S/ -	0.00%	27.0000	930.42	100.00%
05.03.05.10	SUM. /INST. T/PRUEBA HIDRA/TUB PVC D=2" C-5	m	28.00	40.27	1,127.56	0.0000	S/ -	0.00%	0.00	S/ -	0.00%	0.0000	S/ -	0.00%	28.0000	1,127.56	100.00%
05.03.05.11	SUM. /INST. T/PRUEBA HIDRA/TUB PVC D=3" C-5	m	22.50	87.52	1,989.20	0.0000	S/ -	0.00%	0.00	S/ -	0.00%	0.0000	S/ -	0.00%	22.5000	1,989.20	100.00%
05.03.06	SALIDA DE AGUA DE MAR																
05.03.06.01	SALIDA DE AGUA DE MAR CON TUBERIA DE PVC SAP	pto	7.00	94.03	658.21	0.0000	S/ -	0.00%	0.00	S/ -	0.00%	0.0000	S/ -	0.00%	7.0000	658.21	100.00%
05.03.06.02	SALIDA DE AGUA DE MAR CON TUBERIA DE PVC SAP 2"	pto	2.00	138.38	276.76	0.0000	S/ -	0.00%	0.00	S/ -	0.00%	0.0000	S/ -	0.00%	2.0000	276.76	100.00%
05.03.06.03	SALIDA DE AGUA DE MAR COLGADA EN TAREAS PREVIAS	und	56.00	144.77	8,107.12	0.0000	S/ -	0.00%	0.00	S/ -	0.00%	0.0000	S/ -	0.00%	56.0000	8,107.12	100.00%

LUDWING CATRASCO BUSTAMANTE
Ing. Supervisor - CIP 79040
CESEL S.A.

0000075

OBRA: MEJORAMIENTO DE LOS SERVICIOS DEL DESMARCADERO PESQUERO ARTESANAL DE SUPE ,REGION LIMA, PROVINCIA DE BARRANCA, DISTRITO DE SUPE PUERTO
SUB PRES INSTALACIONES SANITARIAS
PROP. FONDERES
CONT. CONSORCIO MARITIMO DEL NORTE
SUP. CESEL

FECHA: mar 02 Oct 2018

ITEM	DESCRIPCION	PRESUPUESTO				VAL. ACUM. ANTERIOR			VAL. ACTUAL			VAL. ACUM. ACTUAL			SALDOS		
		Und.	Metrado	Precio (S./.)	Parcial (S./.)	Metrado	Parcial (S./.)	%	Metrado	Parcial (S./.)	%	Metrado	Parcial (S./.)	%	Metrado	Parcial (S./.)	%
05.03.07	VALVULAS	und	10,00	46,70	467,00	0,0000	S/ -	0,00%	0,00	S/ -	0,00%	0,0000	S/ -	0,00%	10,0000	467,00	100,00%
05.03.07.01	VALVULA COMPUERTA DE BRONCE DE UNION ROSCADA	und	1,00	63,27	83,27	0,0000	S/ -	0,00%	0,00	S/ -	0,00%	0,0000	S/ -	0,00%	1,0000	83,27	100,00%
05.03.07.02	VALVULA COMPUERTA DE BRONCE DE UNION ROSCADA	und	11,00	279,34	3,072,74	0,0000	S/ -	0,00%	0,00	S/ -	0,00%	0,0000	S/ -	0,00%	11,0000	3,072,74	100,00%
05.03.08	VARIOS	und	5,00	60,20	301,00	0,0000	S/ -	0,00%	0,00	S/ -	0,00%	0,0000	S/ -	0,00%	5,0000	301,00	100,00%
05.03.08.01	NICHO Y TAPA DE MADERA PARA VALVULA EN PARED	und	2,00	5,086,39	10,172,78	0,0000	S/ -	0,00%	0,00	S/ -	0,00%	0,0000	S/ -	0,00%	2,0000	10,172,78	100,00%
05.03.09	EQUIPO DE BOMBEO AGUA SALADA A TANQUE ELEVADO	und	1,00	1,385,84	1,385,84	0,0000	S/ -	0,00%	0,00	S/ -	0,00%	0,0000	S/ -	0,00%	1,0000	1,385,84	100,00%
05.03.09.01	ADQUISICION /INST./02 ELECTROBOMBAS Q=3,77LT	und	1,00	1,385,84	1,385,84	0,0000	S/ -	0,00%	0,00	S/ -	0,00%	0,0000	S/ -	0,00%	1,0000	1,385,84	100,00%
05.03.09.02	ACCESORIOS PARA LA BOMBA	und	1,00	1,385,84	1,385,84	0,0000	S/ -	0,00%	0,00	S/ -	0,00%	0,0000	S/ -	0,00%	1,0000	1,385,84	100,00%
05.03.10	SISTEMA DE TRATAMIENTO CLORACION-DESINFECTACION	und	1,00	1,191,84	1,191,84	0,0000	S/ -	0,00%	0,00	S/ -	0,00%	0,0000	S/ -	0,00%	1,0000	1,191,84	100,00%
05.03.10.01	ACCESORIOS PARA SISTEMA DECLORACION Y	und	1,00	1,191,84	1,191,84	0,0000	S/ -	0,00%	0,00	S/ -	0,00%	0,0000	S/ -	0,00%	1,0000	1,191,84	100,00%
05.04	EMISOR SUBMARINO/ AFLUENTES	und	1,00	1,191,84	1,191,84	0,0000	S/ -	0,00%	0,00	S/ -	0,00%	0,0000	S/ -	0,00%	1,0000	1,191,84	100,00%
05.04.01	OBRAS PRELIMINARES	und	2,000,00	12,38	24,760,00	0,0000	S/ -	0,00%	0,00	S/ -	0,00%	0,0000	S/ -	0,00%	2,000,0000	24,760,00	100,00%
05.04.01.01	TACKO Y REPLANTEO EMISOR	und	2,00	689,74	1,379,48	0,0000	S/ -	0,00%	0,00	S/ -	0,00%	0,0000	S/ -	0,00%	2,0000	1,379,48	100,00%
05.04.02	TRAMPA DE SOLIDOS	und	1,00	689,74	689,74	0,0000	S/ -	0,00%	0,00	S/ -	0,00%	0,0000	S/ -	0,00%	1,0000	689,74	100,00%
05.04.02.01	ACCESORIOS PARA TRAMPA DE SOLIDOS	und	1,00	689,74	689,74	0,0000	S/ -	0,00%	0,00	S/ -	0,00%	0,0000	S/ -	0,00%	1,0000	689,74	100,00%
05.04.03	TRAMPA DE GRASAS	und	1,00	689,74	689,74	0,0000	S/ -	0,00%	0,00	S/ -	0,00%	0,0000	S/ -	0,00%	1,0000	689,74	100,00%
05.04.03.01	TANQUE SEPTICO	und	1,00	1,274,85	1,274,85	0,0000	S/ -	0,00%	0,00	S/ -	0,00%	0,0000	S/ -	0,00%	1,0000	1,274,85	100,00%
05.04.04	TANQUE SEPTICO INC. ACCESORIOS	und	1,00	1,274,85	1,274,85	0,0000	S/ -	0,00%	0,00	S/ -	0,00%	0,0000	S/ -	0,00%	1,0000	1,274,85	100,00%
05.04.04.01	CAMARA DE REUNION	und	1,00	1,330,02	1,330,02	0,0000	S/ -	0,00%	0,00	S/ -	0,00%	0,0000	S/ -	0,00%	1,0000	1,330,02	100,00%
05.04.05	ACCESORIOS PARA CAMARA DE REUNION PATIO DE EQUIPO DE BOMBEO	und	2,00	9,922,89	19,845,78	0,0000	S/ -	0,00%	0,00	S/ -	0,00%	0,0000	S/ -	0,00%	2,0000	19,845,78	100,00%
05.04.06.01	SUPMINISTRO PARA BOMBAS SUMERGIBLES	und	1,00	1,385,84	1,385,84	0,0000	S/ -	0,00%	0,00	S/ -	0,00%	0,0000	S/ -	0,00%	1,0000	1,385,84	100,00%
05.04.06.02	TUBERIA DE ACERO SCH-40 CON ROSCA 2"	und	3,00	157,15	471,45	0,0000	S/ -	0,00%	0,00	S/ -	0,00%	0,0000	S/ -	0,00%	3,0000	471,45	100,00%
05.04.06.03	CONSTRUCCION DE CASITA DE BOMBAS DE EMISOR	und	1,00	23,993,32	23,993,32	0,0000	S/ -	0,00%	0,00	S/ -	0,00%	0,0000	S/ -	0,00%	1,0000	23,993,32	100,00%
05.04.07	SUPMINISTRO DE TUBERIAS	und	1,000,00	98,49	98,490,00	0,0000	S/ 62,048,70	63,00%	-70,00	S/ -	-7,00%	560,0000	S/ 55,154,40	56,00%	440,0000	43,335,60	44,00%
05.04.07.01	SUPMINISTRO DE TUBERIA USA HDPE PECC-100 Dext 160mm	m	20,00	98,49	1,969,80	0,0000	S/ -	0,00%	0,00	S/ -	0,00%	0,0000	S/ -	0,00%	20,0000	1,969,80	100,00%
05.04.07.02	SUPMINISTRO DE TUBERIA USA HDPE PECC-100 Dext 160mm	m	1,00	1,393,20	1,393,20	0,0000	S/ -	0,00%	0,00	S/ -	0,00%	0,0000	S/ -	0,00%	1,0000	1,393,20	100,00%
05.04.07.03	SUPMINISTRO E INSTALACION DE LINEA AUXILIAR DE PECC	m	1,00	3,783,24	3,783,24	0,0000	S/ -	0,00%	0,00	S/ -	0,00%	0,0000	S/ -	0,00%	1,0000	3,783,24	100,00%
05.04.07.04	SUPMINISTRO DE ACCESORIOS DE TUBERIA HDPE LASTRE DE	und	500,00	162,54	81,270,00	0,0000	S/ -	0,00%	0,00	S/ -	0,00%	0,0000	S/ -	0,00%	500,0000	81,270,00	100,00%
05.04.07.05	LASTRE DE CONCRETO DE 50KG APROX. TIPO 2 SEPARACION	und	10,00	162,54	1,625,40	0,0000	S/ -	0,00%	0,00	S/ -	0,00%	0,0000	S/ -	0,00%	10,0000	1,625,40	100,00%
05.04.08	TERMOFUSION	und	1,00	9,639,27	9,639,27	0,0000	S/ -	0,00%	0,00	S/ -	0,00%	0,0000	S/ -	0,00%	1,0000	9,639,27	100,00%
05.04.08.01	SERVICIOS DE TERMOFUSION DE TUBERIAS DE 160MM PN-10 Y ULTRASONIDO- CONTROL DE CALIDAD	pb	1,00	7,005,77	7,005,77	0,0000	S/ -	0,00%	0,00	S/ -	0,00%	0,0000	S/ -	0,00%	1,0000	7,005,77	100,00%
05.04.09	INSPECCION ULTRASONICA DE JUNTA	pb	1,00	7,005,77	7,005,77	0,0000	S/ -	0,00%	0,00	S/ -	0,00%	0,0000	S/ -	0,00%	1,0000	7,005,77	100,00%
05.04.09.01	LANZAMIENTO Y HUNDIMIENTO DE LINEA	pb	1,00	15,828,55	15,828,55	0,0000	S/ -	0,00%	0,00	S/ -	0,00%	0,0000	S/ -	0,00%	1,0000	15,828,55	100,00%
05.04.10.01	LANZAMIENTO Y HUNDIMIENTO DE LINEA	pb	8,00	903,86	7,230,88	0,0000	S/ -	0,00%	0,00	S/ -	0,00%	0,0000	S/ -	0,00%	8,0000	7,230,88	100,00%
05.04.10.02	FLAJACION PRIMEROS METROS DE TUBERIA CONCRETO	pb	1,00	14,398,52	14,398,52	0,0000	S/ -	0,00%	0,00	S/ -	0,00%	0,0000	S/ -	0,00%	1,0000	14,398,52	100,00%
05.04.10.03	PRUEBAS Y PUESTA EN MARCHA DE EMISOR SUBMARINO	pb	1,00	14,398,52	14,398,52	0,0000	S/ -	0,00%	0,00	S/ -	0,00%	0,0000	S/ -	0,00%	1,0000	14,398,52	100,00%

LUDWIG CARRASCO BUSTAMANTE
Ing. Supervisor - CIP 79040
CESEL S.A.

7700000



VALORIZACIÓN 17 - ENERO 2019 - INSTALACIONES SANITARIAS

Contrato N° 025-2017- FONDEPES Ejecucion de la Obra: MEJORAMIENTO DE LOS SERVICIOS DEL DESEMBARCADERO PESQUERO ARTESANAL DE SUPE, REGION LIMA, PROVINCIA DE BARRANCA, DISTRITO DE SUPE PUERTO



OBRA: MEJORAMIENTO DE LOS SERVICIOS DEL DESEMBARCADERO PESQUERO ARTESANAL DE SUPE ,REGION LIMA, PROVINCIA DE BARRANCA, DISTRITO DE SUPE PUERTO
 SUB PRES INSTALACIONES SANITARIAS
 PROP. FONDEPES
 CONT. CONSORCIO MARITIMO DEL NORTE
 SUP. CESEL

FECHA: mar 02 Oct 2018

ITEM	DESCRIPCION	PRESUPUESTO				VAL. ACUM. ANTERIOR			VAL. ACTUAL			VAL. ACUM. ACTUAL			SALDOS		
		Und.	Metrado	Precio (S/.)	Parcial (S/.)	Metrado	Parcial (S/.)	%	Metrado	Parcial (S/.)	%	Metrado	Parcial (S/.)	%	Metrado	Parcial (S/.)	%
05.05	APARATOS Y ACCESORIOS SANITARIOS																
05.05.01	APARATOS SANITARIOS																
05.05.01.01	INODORO COLOR BLANCO CON ASIENTO	und	18.00	356.80	6,422.40	0.0000	S/ -	0.00%	0.00	S/ -	0.00%	0.0000	S/ -	0.00%	18.0000	6,422.40	100.00%
05.05.01.02	URINARIO	und	7.00	406.29	2,844.03	0.0000	S/ -	0.00%	0.00	S/ -	0.00%	0.0000	S/ -	0.00%	7.0000	2,844.03	100.00%
05.05.02	LAVATORIOS																
05.05.02.01	LAVATORIO DE PARED	und	19.00	203.51	3,866.69	0.0000	S/ -	0.00%	0.00	S/ -	0.00%	0.0000	S/ -	0.00%	19.0000	3,866.69	100.00%
05.05.02.02	LAVADERO DE COCINA DE ACERO INOXIDABLE	und	2.00	432.79	865.59	0.0000	S/ -	0.00%	0.00	S/ -	0.00%	0.0000	S/ -	0.00%	2.0000	865.59	100.00%
05.05.02.03	DUCHA CROMADA DE CABEZA GIRATORIA Y LLAVE MEZCLADORA	und	9.00	241.54	2,173.86	0.0000	S/ -	0.00%	0.00	S/ -	0.00%	0.0000	S/ -	0.00%	9.0000	2,173.86	100.00%
05.05.02.04	GRIFERIA PARA LAVADERO	und	19.00	221.35	4,205.65	0.0000	S/ -	0.00%	0.00	S/ -	0.00%	0.0000	S/ -	0.00%	19.0000	4,205.65	100.00%
05.05.02.05	PAPELERA CON EJE ADHESIVO C/SILICONA BLANCO	und	18.00	155.82	2,804.76	0.0000	S/ -	0.00%	0.00	S/ -	0.00%	0.0000	S/ -	0.00%	18.0000	2,804.76	100.00%
05.05.02.06	TOALLERO DE BARRA	und	9.00	161.37	1,452.33	0.0000	S/ -	0.00%	0.00	S/ -	0.00%	0.0000	S/ -	0.00%	9.0000	1,452.33	100.00%
05.05.02.07	MANILUVIOS/GRIFOS	und	2.00	325.94	651.88	0.0000	S/ -	0.00%	0.00	S/ -	0.00%	0.0000	S/ -	0.00%	2.0000	651.88	100.00%
	COSTO DIRECTO				670,659.81				87,755.58								
	GASTOS GENERALES		20.083931%		134,694.85				17,624.77								
	UTILIDAD		2.32247929%		15,575.94				2,038.11								
	SUB TOTAL				820,930.60				107,418.45								
	IGY 18%		18.00%		147,767.51				19,335.32								
	PRESUPUESTO TOTAL				968,698.10				126,753.77								
									-6,713.70						81,041.88	12.08%	589,617.92
									-1,348.37						16,276.40		118,418.46
									-155.92						1,882.19		13,693.75
									-8,217.99						99,200.46		721,730.13
									-1,479.24						17,856.08		129,911.42
									-9,697.23						117,056.55		851,641.56

LUDWING CARRASCO BUSTAMANTE
 Ing. Supervisor - CIP 79040
 CESEL S.A.

370000



VALORIZACIÓN N° 18 DEL 01 AL 28 DE FEBRERO DEL 2019 (PRECIOS UNITARIOS)

Contrato N° 025-2017- FONDEPES Ejecución de la Obra: MEJORAMIENTO DE LOS SERVICIOS DEL DESEMBARCADERO PESQUERO ARTESANAL DE SUPE, REGION LIMA, PROVINCIA DE BARRANCA, DISTRITO DE SUPE PUERTO



OBRA: MEJORAMIENTO DE LOS SERVICIOS DEL DESEMBARCADERO PESQUERO ARTESANAL DE SUPE, REGION LIMA, PROVINCIA DE BARRANCA, DISTRITO DE SUPE PUERTO
SUB PRES: OBRAS EN TIERRA - EQUIPAMIENTO
PROP: FONDEPES
CONT: CONSORCIO MARITIMO DEL NORTE
SUP: CESEL

FECHA: 14 de 02 Mar 2019

ITEM	DESCRIPCION	PRESUPUESTO				VAL. ACUM. ANTERIOR			VAL. ACTUAL			VAL. ACUM. ACTUAL			SALDOS		
		Und.	Medrado	Precio (\$/.)	Parcial (\$/.)	Medrado	Parcial (\$/.)	%	Medrado	Parcial (\$/.)	%	Medrado	Parcial (\$/.)	%	Medrado	Parcial (\$/.)	%
06	EQUIPAMIENTO																
06.01	UNIDAD FRIGORIFICA																
06.01.2001	SUMINISTRO E INSTALACION DE CAMARA FRIGORIFICA DSE 10TM- 12°C PARA PRODUCTOS HIDROBIOLOGICOS	und	1.00	126,314.62	126,314.62	0.75	S/ 94,735.97	75.00%	0.0000	0.00	0.00%	0.75	S/ 94,735.97	75.00%	0.25	S/ 31,578.66	25.00%
06.01.2002	SUMINISTRO E INSTALACION DE CAMARA FRIGORIFICA DSE 10TM- 0°C PARA HIELO EN BLOQUES	und	1.00	126,314.62	126,314.62	0.75	S/ 94,735.97	75.00%	0.0000	0.00	0.00%	0.25	S/ 31,578.66	25.00%	0.25	S/ 31,578.66	25.00%
06.01.2003	SUMINISTRO E INSTALACION DE PRODUCTOR DE HIELO EN BLOQUES DE 20TN/DIA	und	1.00	1,179,475.89	1,179,475.89	0.75	S/ 884,606.92	75.00%	0.0000	0.00	0.00%	0.25	S/ 294,868.97	25.00%	0.25	S/ 294,868.97	25.00%
06.01.2004	SUMINISTRO E INSTALACION DE ENFRIADOR DE AGUA + 15°C	und	1.00	69,938.87	69,938.87	0.75	S/ 52,454.15	75.00%	0.0000	0.00	0.00%	0.25	S/ 17,484.72	25.00%	0.25	S/ 17,484.72	25.00%
06.02	EQUIPAMIENTO EN AREA DE TAREAS PREVIAS																
06.02.2001	TINAS DE ACERO INOXIDABLE DE 0.90m3	und	7.00	7,720.47	54,043.29	0.0000	S/ -	0.00%	0.0000	0.00	0.00%	0.0000	S/ -	0.00%	7.00	S/ 54,043.29	100.00%
06.02.2002	MESAS DE ACERO INOX PARA 06 PERSONAS	und	7.00	6,853.12	47,971.84	0.00	S/ -	0.00%	0.0000	0.00	0.00%	0.00	S/ -	0.00%	7.00	S/ 47,971.84	100.00%
06.02.2003	CARRETAS DE ACERO INOXIDABLES CARGA 1 TM (INC. SUM. Y COL.)	und	12.00	5,731.33	68,775.96	0.0000	S/ -	0.00%	0.0000	0.00	0.00%	0.0000	S/ -	0.00%	12.00	S/ 68,775.96	100.00%
06.03	ACCESORIOS PARA TRANSPORTE Y ESTRIBA																
06.03.2001	DEPOSITO DE RESIDUOS SOLIDOS	und	10.00	3,862.35	38,623.50	0.0000	S/ -	0.00%	0.0000	0.00	0.00%	0.0000	S/ -	0.00%	10.00	S/ 38,623.50	100.00%
06.03.2002	CONTENEDOR DE POLIETILENO DE 1000 LITROS	und	3.00	1,691.33	5,073.99	0.00	S/ -	0.00%	0.0000	0.00	0.00%	0.00	S/ -	0.00%	3.00	S/ 5,073.99	100.00%
06.03.2003	CONTENEDORES DE POLIETILENO RODANTE DE 360 LITROS	und	5.00	658.67	3,293.35	0.0000	S/ -	0.00%	0.0000	0.00	0.00%	0.0000	S/ -	0.00%	5.00	S/ 3,293.35	100.00%
06.03.2004	CARRETIILLAS HIDRAULICAS CARGA 2500KG	und	6.00	8,738.13	52,428.78	0.00	S/ -	0.00%	0.0000	0.00	0.00%	0.00	S/ -	0.00%	6.00	S/ 52,428.78	100.00%
06.03.2005	CARRETIILLAS HIDRAULICA-ELEVADOR DE 1.5TN	und	2.00	7,621.03	15,642.06	0.0000	S/ -	0.00%	0.0000	0.00	0.00%	0.0000	S/ -	0.00%	2.00	S/ 15,642.06	100.00%
06.03.2006	BALANZA DE PLATAFORMA (ELECTRONICO)	und	1.00	21,024.04	21,024.04	0.00	S/ -	0.00%	0.0000	0.00	0.00%	0.00	S/ -	0.00%	1.00	S/ 21,024.04	100.00%
06.03.2007	BALANZA DE PIE (ELECTRONICA) CAP 200 KG	und	8.00	1,946.79	15,574.32	0.0000	S/ -	0.00%	0.0000	0.00	0.00%	0.0000	S/ -	0.00%	8.00	S/ 15,574.32	100.00%
06.03.2008	PARHUELA DE PLASTICO CAP 1200 KG (INC. SUM. COL.)	und	30.00	313.44	9,403.20	0.00	S/ -	0.00%	0.0000	0.00	0.00%	0.00	S/ -	0.00%	30.00	S/ 9,403.20	100.00%
06.03.2009	CAJAS PLASTICAS DE CAPACIDAD DE 40 KG	und	100.00	76.25	7,625.00	0.0000	S/ -	0.00%	0.0000	0.00	0.00%	0.0000	S/ -	0.00%	100.00	S/ 7,625.00	100.00%
06.03.2010	DINO	und	6.00	1,218.81	7,312.86	0.00	S/ -	0.00%	0.0000	0.00	0.00%	0.00	S/ -	0.00%	6.00	S/ 7,312.86	100.00%
06.04	ACCESORIOS PARA PERSONAL OPERATIVO																
06.04.2001	ROPA DE TRABAJO PARA OPERARIOS	und	85.00	188.20	15,997.00	0.00	S/ -	0.00%	0.0000	0.00	0.00%	0.00	S/ -	0.00%	85.00	S/ 15,997.00	100.00%
06.04.2002	ESTANTES PARA VESTUARIO (Accesorios, suministro y colocación)	und	20.00	959.54	19,390.80	0.0000	S/ -	0.00%	0.0000	0.00	0.00%	0.0000	S/ -	0.00%	20.00	S/ 19,390.80	100.00%
06.04.2003	BANCAS DE MADERA DE 1.50 x 0.40m	und	5.00	358.85	1,794.25	0.00	S/ -	0.00%	0.0000	0.00	0.00%	0.00	S/ -	0.00%	5.00	S/ 1,794.25	100.00%
06.05	MOBILIARIO																
06.05.2001	MESAS DE MELAMINE	und	1.00	1,265.05	1,265.05	0.00	S/ -	0.00%	0.0000	0.00	0.00%	0.00	S/ -	0.00%	1.00	S/ 1,265.05	100.00%
06.05.2002	ARMARIO 1.80 X 0.80 X 0.40m	und	3.00	791.00	2,373.00	0.0000	S/ -	0.00%	0.0000	0.00	0.00%	0.0000	S/ -	0.00%	3.00	S/ 2,373.00	100.00%
06.05.2003	SILLAS TANDEM DE 3 CUERPOS	und	20.00	472.47	9,449.40	0.00	S/ -	0.00%	0.0000	0.00	0.00%	0.00	S/ -	0.00%	20.00	S/ 9,449.40	100.00%
06.05.2004	ARCHIVADOR 4 GAVETAS	und	4.00	654.37	2,617.48	0.0000	S/ -	0.00%	0.0000	0.00	0.00%	0.0000	S/ -	0.00%	4.00	S/ 2,617.48	100.00%
06.05.2005	SILLAS FIJAS	und	12.00	91.26	1,095.12	0.00	S/ -	0.00%	0.0000	0.00	0.00%	0.00	S/ -	0.00%	12.00	S/ 1,095.12	100.00%
06.05.2006	ESCRITORIO EN L (1.50 X 0.70m)	jgo	4.00	1,019.14	4,076.56	0.0000	S/ -	0.00%	0.0000	0.00	0.00%	0.0000	S/ -	0.00%	4.00	S/ 4,076.56	100.00%
06.05.2007	SILLON MECANICO C/BRAZO	und	4.00	543.05	2,172.20	0.00	S/ -	0.00%	0.0000	0.00	0.00%	0.00	S/ -	0.00%	4.00	S/ 2,172.20	100.00%
06.05.2008	MESA DE PLASTICO C/ 4 SILLAS	jgo	10.00	369.93	3,699.30	0.0000	S/ -	0.00%	0.0000	0.00	0.00%	0.0000	S/ -	0.00%	10.00	S/ 3,699.30	100.00%
06.06	EQUIPOS INFORMATIVOS																
06.06.2001	COMPUTADORAS (Inc. Accesorios e inst.)	und	2.00	4,004.02	8,008.04	0.0000	S/ -	0.00%	0.0000	0.00	0.00%	0.0000	S/ -	0.00%	2.00	S/ 8,008.04	100.00%
06.06.2002	PROYECTOR MULTIMEDIA	und	1.00	5,420.23	5,420.23	0.00	S/ -	0.00%	0.0000	0.00	0.00%	0.00	S/ -	0.00%	1.00	S/ 5,420.23	100.00%
06.06.2003	PANTALLA ECRAN	und	1.00	3,045.60	3,045.60	0.0000	S/ -	0.00%	0.0000	0.00	0.00%	0.0000	S/ -	0.00%	1.00	S/ 3,045.60	100.00%
06.06.2004	IMPRESORA MULTIFUNCIONAL	und	2.00	1,384.07	2,768.14	0.00	S/ -	0.00%	0.0000	0.00	0.00%	0.00	S/ -	0.00%	2.00	S/ 2,768.14	100.00%
06.06.2005	ESCANNER	und	1.00	3,313.44	3,313.44	0.0000	S/ -	0.00%	0.0000	0.00	0.00%	0.0000	S/ -	0.00%	1.00	S/ 3,313.44	100.00%
06.06.2006	MODULO PARA TV	und	1.00	318.82	318.82	0.00	S/ -	0.00%	0.0000	0.00	0.00%	0.00	S/ -	0.00%	1.00	S/ 318.82	100.00%
06.06.2007	TELEVISOR 48"	und	1.00	3,313.44	3,313.44	0.0000	S/ -	0.00%	0.0000	0.00	0.00%	0.0000	S/ -	0.00%	1.00	S/ 3,313.44	100.00%
	COSTO DIRECTO				1,938,954.06							1,126,533.00					812,421.06
	GASTOS GENERALES				389,418.19							226,252.11					163,166.08
	UTILIDAD				45,031.81							26,163.50					18,868.31
	SUB TOTAL				2,373,404.06							1,378,948.60					994,455.45
	IGV 18%				427,212.73							0.00					179,001.98
	PRESUPUESTO TOTAL				2,800,616.79							1,378,948.60					1,173,457.44

LUDWIG CARRASCO BUSTAMANTE
Ing. Supervisor - CIP 79040
CESEL S.A.

000002



**VALORIZACIÓN N° 18 DEL 01 AL 28 DE FEBRERO DEL 2019
(PRECIOS UNITARIOS)**

Contrato N° 025-2017- FONDEPES Ejecución de la Obra:
MEJORAMIENTO DE LOS SERVICIOS DEL DESEMBARCADERO
PESQUERO ARTESANAL DE SUPE, REGION LIMA, PROVINCIA DE
BARRANCA, DISTRITO DE SUPE PUERTO



OBRA: MEJORAMIENTO DE LOS SERVICIOS DEL DESEMBARCADERO PESQUERO ARTESANAL DE SUPE ,REGION LIMA, PROVINCIA DE BARRANCA, DISTRITO DE SUPE PUERTO
SUB PRES: IMPACTO AMBIENTAL
PROP: FONDEPES
CONT: CONSORCIO MARITIMO DEL NORTE
SUP: CESEL

FECHA: sáb 02 Mar 2019

ITEM	DESCRIPCION	PRESUPUESTO			VAL. ACUM. ANTERIOR			VAL. ACTUAL			VAL. ACUM. ACTUAL			SALDO			
		Und.	Metrado	Precio (S/.)	Parcial (S/.)	Metrado	Parcial (S/.)	%	Metrado	Parcial (S/.)	%	Metrado	Parcial (S/.)	%	Metrado	Parcial (S/.)	%
07	IMPACTO AMBIENTAL																
07.01	MANEJO DE RESIDUOS SOLIDOS Y EFLUENTES																
07.01.2001	SUMINISTRO E INSTALACION DE CONTENEDOR DE BASURA	und	20.00	S/ 243.59	S/ 4,871.80	19.50	S/ 4,750.01	97.50%	0.00	0.00	0.00%	19.50	S/4,750.01	97.50%	0.50	121.80	2.50%
07.01.2002	AREA DE ALMACENAMIENTO TEMPORAL	glb	1.00	S/ 1,328.71	S/ 1,328.71	1	S/ 1,328.71	100.00%	0.00	0.00	0.00%	1	S/1,328.71	100.00%	0.00	0.00	0.00%
07.01.2003	CILINDRO METALICOS PARA ALMACENAMIENTO DE EFLUENTES INDUSTRIALES	und	5.00	S/ 422.87	S/ 2,114.35	5.00	S/ 2,114.35	100.00%	0.00	0.00	0.00%	5.00	S/2,114.35	100.00%	0.00	0.00	0.00%
07.01.2004	ALQUILER BAÑOS QUIMICOS 8 UNIDADES INC. INSTALACION Y OPERACION	mes	9.00	S/ 910.19	S/ 8,191.71	9	S/ 8,191.71	100.00%	0.00	0.00	0.00%	9	S/8,191.71	100.00%	0.00	0.00	0.00%
07.01.2005	TRANSPORTE Y DISPOSICION DE RESIDUOS PELIGROSOS	und	9.00	S/ 348.84	S/ 3,139.56	8.00	S/ 2,790.72	88.89%	0.00	0.00	0.00%	8.00	S/2,790.72	88.89%	1.00	348.84	11.11%
07.02	SEÑALIZACION AMBIENTAL Y SEGURIDAD																
07.02.2001	SEÑALIZACION TEMPORAL	und	30.00	S/ 65.45	S/ 1,963.50	30.00	S/ 1,963.50	100.00%	0.00	0.00	0.00%	30.00	S/1,963.50	100.00%	0.00	0.00	0.00%
07.02.2002	SEÑALIZACION PERMANENTE	und	20.00	S/ 100.69	S/ 2,013.80	20	S/ 2,013.80	100.00%	0.00	0.00	0.00%	20.00	S/2,013.80	100.00%	0.00	0.00	0.00%
07.03	CAPACITACION EN TEMAS AMBIENTALES Y SEGURIDAD																
07.03.2001	CHARLA DE SEGURIDAD EN OBRA PARA PERSONAL	und	9.00	S/ 232.56	S/ 2,093.04	9.00	S/ 2,093.04	100.00%	0.00	0.00	0.00%	9.00	S/2,093.04	100.00%	0.00	0.00	0.00%
07.03.2002	CHARLA SOBRE TEMAS AMBIENTALES - PESCADORES	und	2.00	S/ 872.09	S/ 1,744.18	1.4	S/ 1,220.93	70.00%	0.00	0.00	0.00%	1.4	S/1,220.93	70.00%	0.60	523.25	30.00%
07.04	MITIGACION IMPACTOS EN MEDIO AMBIENTE																
07.04.2001	SERV. MONITOREO AMBIENTAL, CALIDAD AIRE, AGUA, RUIDO	und	1.00	S/ 1,395.34	S/ 1,395.34	0.50	S/ 697.67	50.00%	0.00	0.00	0.00%	0.50	S/697.67	50.00%	0.50	697.67	50.00%
07.04.2002	MEDIDAS MITIGACION EMISION DE POLVO	glb	1.00	S/ 2,906.96	S/ 2,906.96	0.25	S/ 726.74	25.00%	0.00	0.00	0.00%	0.25	S/726.74	25.00%	0.75	2,180.22	75.00%
07.04.2003	MEDIDAS MITIGACION RUIDO	und	1.00	S/ 2,768.48	S/ 2,768.48	0.25	S/ 692.12	25.00%	0.00	0.00	0.00%	0.25	S/692.12	25.00%	0.75	2,076.36	75.00%
07.04.2004	MEDIDAS MITIGACION CONTAMINACION DE AGUA	glb	1.00	S/ 2,844.34	S/ 2,844.34	0.25	S/ 711.09	25.00%	0.00	0.00	0.00%	0.25	S/711.09	25.00%	0.75	2,133.26	75.00%
07.05	PROGRAMA DE CONTINGENCIAS																
07.05.2001	PRIMEROS AUXILIOS	glb	1.00	S/ 1,744.18	S/ 1,744.18	0.50	S/ 872.09	50.00%	0.00	0.00	0.00%	0.50	S/872.09	50.00%	0.50	872.09	50.00%
07.05.2002	CONTRA INCENDIO	est	1.00	S/ 1,860.44	S/ 1,860.44	0.50	S/ 930.22	50.00%	0.00	0.00	0.00%	0.50	S/930.22	50.00%	0.50	930.22	50.00%
07.06	PROGRAMA DE CIERRE DE OBRA																
07.06.2001	DESMANTELAMIENTO DE ESTRUCTURAS TEMPORALES	glb	1.00	S/ 3,100.32	S/ 3,100.32	0.00	S/ -	0.00%	0.00	0.00	0.00%	0.00	S/0.00	0.00%	1.00	3,100.32	100.00%
	COSTO DIRECTO				44,080.71		31,096.69	1.22%		0.00	0.00%		31,096.69	70.54%		12,984.02	29.46%
	GASTOS GENERALES				8,853.14		6,245.44			0.00			6,245.44			2,607.70	
	UTILIDAD		20.083931%		1,023.77		722.21			0.00			722.21			301.55	
	SUB TOTAL				53,957.61		38,064.34			0.00			38,064.34			15,893.28	
	Igv 18%		18.00%		9,712.37		6,851.58			0.00			6,851.58			2,860.79	
	PRESUPUESTO TOTAL				63,669.99		44,915.92			0.00			44,915.92			18,754.07	

[Signature]
LUDWING CARRASCO BUSTAMANTE
Ing. Supervisor - CIP 79040
CESEL S.A.

1100001

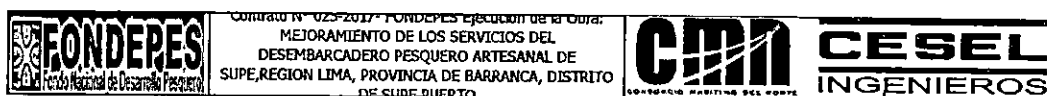

Contrato N° 025-2017 FONDEPES Ejecución de la Obra:
MEJORAMIENTO DE LOS SERVICIOS DEL
DESEMBARCADERO PESQUERO ARTESANAL DE
SUPE, REGION LIMA, PROVINCIA DE BARRANCA, DISTRITO
DE SUPE PUERTO

RESUMEN

VALORIZACIÓN N° 18 DEL 01 AL 28 DE FEBRERO DE 2019

OBRA: MEJORAMIENTO DE LOS SERVICIOS DEL DESEMBARCADERO PESQUERO ARTESANAL DE SUPE, REGION LIMA, PROVINCIA DE BARRANCA, DISTRITO DE SUPE
PROP: FONDEPES
CONTRAT: CONSORCIO MARITIMO DEL NORTE
SUPERV: CESEL

CONCEPTOS	VALORIZACION ACTUAL	VALORIZACION ACUMULADA ANTERIOR	VALORIZACION ACUMULADA ACTUAL
1.1 MONTO VAL. OBRAS PORTUARIAS	178,769.65	3,275,986.89	3,454,756.55
1.2 REAJUSTE DE VAL. OBRAS PORTUARIAS	15,253.00	88,549.96	103,802.95
2.1 MONTO VAL. EDIFICIO EN TIERRA ESTRUCTURA	17,206.86	2,834,424.52	2,851,631.39
2.2 REAJUSTE DE VAL. EDIFICIO EN TIERRA ESTRUCTURA	1,130.46	76,151.75	77,282.22
3.1 MONTO VAL. EDIFICIO EN TIERRA ARQUITECTURA	77,103.98	566,042.55	643,146.53
3.2 REAJUSTE DE VAL. EDIFICIO EN TIERRA ARQUITECTURA	5,788.58	36,760.71	42,549.29
4.1 MONTO VAL. EDIF. EN TIERRA INSTALACIONES ELECTRICAS	-	35,414.48	35,414.48
4.2 REAJUSTE DE VAL. EDIF. EN TIERRA INSTALACIONES ELECTRICAS	-	-25,784.03	-25,784.03
5.1 MONTO VAL. EDIF. EN TIERRA INSTALACIONES SANITARIAS	-8,217.99	107,418.46	99,200.47
5.2 REAJUSTE DE VAL. EDIF. EN TIERRA INSTALACIONES SANITARIAS	-1,463.55	18,606.66	17,143.11
6.1 MONTO VAL. EDIFICIO EN TIERRA EQUIPAMIENTO	-	1,378,948.60	1,378,948.60
6.2 REAJUSTE DE VAL. EDIFICIO EN TIERRA EQUIPAMIENTO	-	12,173.65	12,173.65
7.1 MONTO VAL. IMPACTO AMBIENTAL	-	38,064.34	38,064.34
7.2 REAJUSTE DE VAL. IMPACTO AMBIENTAL	-	442.34	442.34
A. TOTAL VALORIZACION REAJUSTADA	285,571.00	8,443,200.89	8,728,771.89
2.0 AMORTIZACIONES			
2.0 OBRAS PORTUARIAS			
2.1 ADELANTO DIRECTO	22,167.44	337,806.01	359,973.45
2.2 ADELANTO DE MATERIALES N°01	-	764,067.67	764,067.67
2.3 ADELANTO DE MATERIALES N°02	94,732.83	268,988.35	363,721.17
2.4 ADELANTO DE MATERIALES N°03	-	-	-
2 EDIFICIO EN TIERRA ESTRUCTURA			
2.1 ADELANTO DIRECTO	2,133.65	305,630.78	307,764.43
2.2 ADELANTO DE MATERIALES N°01	-	208,786.47	208,786.47
2.3 ADELANTO DE MATERIALES N°02	6,447.98	471,845.27	478,293.25
2.4 ADELANTO DE MATERIALES N°03	179.03	20,889.64	21,068.68
2 EDIFICIO EN TIERRA ARQUITECTURA			
2.1 ADELANTO DIRECTO	9,560.89	65,783.00	75,343.89
2.2 ADELANTO DE MATERIALES N°01	-	-	-
2.3 ADELANTO DE MATERIALES N°02	5,281.74	33,722.15	39,003.89
2.4 ADELANTO DE MATERIALES N°03	-	-	-
2 EDIF. EN TIERRA INSTALACIONES ELECTRICAS			
2.1 ADELANTO DIRECTO	-	4,117.75	4,117.75
2.2 ADELANTO DE MATERIALES	-	-	-
2 EDIF. EN TIERRA INSTALACIONES SANITARIAS			
2.1 ADELANTO DIRECTO	-1,019.03	12,715.50	11,696.47
2.2 ADELANTO DE MATERIALES	-	-	-
2 EDIFICIO EN TIERRA EQUIPAMIENTO			
2.1 ADELANTO DIRECTO	-	154,993.82	154,993.82
2.2 ADELANTO DE MATERIALES	-	-	-
2 IMPACTO AMBIENTAL			
2.1 ADELANTO DIRECTO	-	4,000.49	4,000.49
2.2 ADELANTO DE MATERIALES	-	-	-

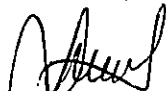
LUDWIG CARRASCO BUSTAMANTE
Ing. Supervisor - CIP 79040
CESEL S.A.



Contrato N° 025-2017- PONDERES Evolución de la Obra: MEJORAMIENTO DE LOS SERVICIOS DEL DESEMBARCADERO PESQUERO ARTESANAL DE SUPLEAGION LIMA, PROVINCIA DE BARRANCA, DISTRITO DE SUPLE PUERTO



VALORIZACIÓN N° 18 DEL 01 AL 28 DE FEBRERO DE 2019

OBRA:
PRESUPUESTO:
CONTRATADO:
PONDERES
CONSORCIO MARITIMO DEL NORTE
CESEL

MEJORAMIENTO DE LOS SERVICIOS DEL DESEMBARCADERO PESQUERO ARTESANAL DE SUPLEAGION LIMA, PROVINCIA DE BARRANCA, DISTRITO DE SUPLE PUERTO

CURVA "S"
Programado vs Ejecutado
GENERAL

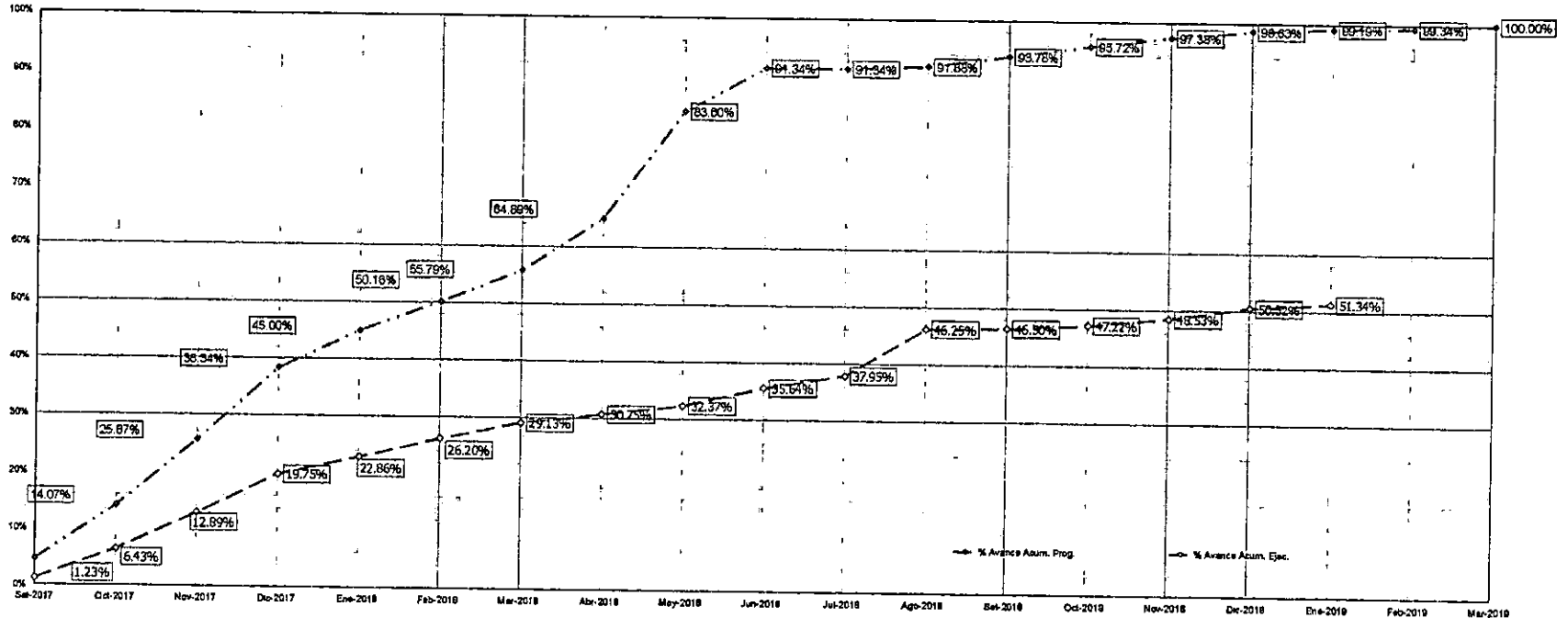

COSTO DIRECTO - AVANCE PROGRAMADO

Monto mes	Sep-2017	Oct-2017	Nov-2017	Dic-2017	Ene-2018	Feb-2018	Mar-2018	Abr-2018	May-2018	Jun-2018	Jul-2018	Ago-2018	Sep-2018	Oct-2018	Nov-2018	Dic-2018	Ene-2019	Feb-2019	Mar-2019	
Monto Acumulado	S/ 715,729.71	S/ 1,547,435.10	S/ 2,450,421.27	S/ 2,922,426.36	S/ 3,106,372.55	S/ 3,724,346.62	S/ 4,799,354.41	S/ 5,452,334.90	S/ 7,045,803.24	S/ 10,343,862.89	S/ 13,339,869.24	S/ 14,674,232.23	S/ 14,674,232.23	S/ 14,651,542.83	S/ 15,339,258.34	S/ 15,339,258.34	S/ 15,339,258.34	S/ 15,339,258.34	S/ 15,339,258.34	S/ 15,339,258.34
% de avance del mes	4.81%	11.66%	11.66%	12.89%	8.49%	16.14%	24.91%	18.71%	22.57%	32.57%	29.13%	22.89%	0.00%	0.55%	4.39%	1.90%	1.84%	0.00%	0.00%	0.00%
% Avance Acum. Prog.	4.81%	14.07%	25.87%	35.34%	45.00%	50.18%	55.76%	64.88%	83.80%	91.94%	97.85%	99.78%	99.78%	99.72%	99.72%	99.72%	99.72%	99.72%	99.72%	99.72%

COSTO DIRECTO - AVANCE EJECUTADO

Monto mes	Sep-2017	Oct-2017	Nov-2017	Dic-2017	Ene-2018	Feb-2018	Mar-2018	Abr-2018	May-2018	Jun-2018	Jul-2018	Ago-2018	Sep-2018	Oct-2018	Nov-2018	Dic-2018	Ene-2019	Feb-2019	Mar-2019	
Monto mes	S/ 184,076.67	S/ 824,218.63	S/ 1,022,421.99	S/ 1,086,632.73	S/ 313,043.75	S/ 358,408.26	S/ 184,369.33	S/ 186,335.23	S/ 130,963.94	S/ 224,331.06	S/ 249,082.03	S/ 1,300,892.42	S/ 3,748.41	S/ 114,864.34	S/ 154,285.20	S/ 314,837.23	S/ 102,121.12	S/ 278,379.60	-	-
Monto mes Adicional N°01	-	-	-	-	-	-	-	-	-	-	-	-	-	-	-	-	-	-	-	-
Monto mes Adicional N°02	-	-	-	-	-	-	-	-	-	-	-	-	-	-	-	-	-	-	-	-
Monto mes Adicional N°04	-	-	-	-	-	-	-	-	-	-	-	-	-	-	-	-	-	-	-	-
Monto mes Adicional N°05	-	-	-	-	-	-	-	-	-	-	-	-	-	-	-	-	-	-	-	-
Monto mes Adicional N°06	-	-	-	-	-	-	-	-	-	-	-	-	-	-	-	-	-	-	-	-
Monto Total mes	S/ 184,076.67	S/ 824,218.63	S/ 1,022,421.99	S/ 1,086,632.73	S/ 313,043.75	S/ 358,408.26	S/ 184,369.33	S/ 186,335.23	S/ 130,963.94	S/ 224,331.06	S/ 249,082.03	S/ 1,300,892.42	S/ 3,748.41	S/ 114,864.34	S/ 154,285.20	S/ 314,837.23	S/ 102,121.12	S/ 278,379.60	-	-
Monto Acumulado	S/ 184,076.67	S/ 1,010,295.30	S/ 2,042,717.29	S/ 3,129,349.02	S/ 3,442,392.77	S/ 3,800,801.03	S/ 3,985,170.36	S/ 4,171,505.59	S/ 4,302,469.53	S/ 4,526,800.59	S/ 4,775,882.62	S/ 6,076,775.04	S/ 6,080,523.45	S/ 6,195,387.79	S/ 6,350,672.99	S/ 6,665,510.22	S/ 6,979,631.34	S/ 7,258,010.94	S/ 7,536,390.54	S/ 7,814,769.14
% de avance del mes	1.23%	9.21%	8.48%	9.96%	3.11%	3.34%	1.84%	1.81%	1.23%	2.25%	2.36%	1.30%	0.25%	0.94%	1.03%	0.91%	0.31%	0.94%	1.00%	1.00%
% Avance Acum. Eje.	1.23%	10.44%	18.92%	28.88%	32.00%	35.34%	37.13%	38.94%	40.17%	42.42%	44.78%	46.08%	46.33%	47.27%	48.60%	49.51%	50.42%	51.36%	52.30%	53.24%
Monto Total mes	S/ 184,076.67	S/ 824,218.63	S/ 1,022,421.99	S/ 1,086,632.73	S/ 313,043.75	S/ 358,408.26	S/ 184,369.33	S/ 186,335.23	S/ 130,963.94	S/ 224,331.06	S/ 249,082.03	S/ 1,300,892.42	S/ 3,748.41	S/ 114,864.34	S/ 154,285.20	S/ 314,837.23	S/ 102,121.12	S/ 278,379.60	-	-
Porcentaje Ejecutado (Programado)	23.12%	43.72%	60.21%	61.62%	60.81%	63.24%	62.43%	67.31%	39.73%	59.02%	41.03%	69.34%	49.89%	61.34%	49.81%	61.22%	61.77%	63.40%	-	-

[Signature]
LUIGING CARRASCO BUSTAMANTE
Ing. Supervisor - CIP 79040
CESEL S.A.

600000



**VALORIZACIÓN N° 18 DEL 01 AL 28 DE FEBRERO DEL 2019
(PRECIOS UNITARIOS)**

Contrato N° 025-2017- FONDEPES Ejecución de la Obra: MEJORAMIENTO DE LOS SERVICIOS DEL DESEMBARCADERO PESQUERO ARTESANAL DE SUPE, REGION LIMA, PROVINCIA DE BARRANCA, DISTRITO DE SUPE PUERTO



OBRA: MEJORAMIENTO DE LOS SERVICIOS DEL DESEMBARCADERO PESQUERO ARTESANAL DE SUPE ,REGION LIMA, PROVINCIA DE BARRANCA, DISTRITO DE SUPE PUERTO
 PROP. FONDEPES
 CONT. CONSORCIO MARITIMO DEL NORTE
 SUP. CESEL
FORMULA POLINÓMICA N° 01: **OBRAS PORTUARIAS**

Valorización N°:	18
Fecha:	sáb 02 Mar 2019
Monto Contrato:	S/. 8,897,118.06 (S/. IGV.) S/. 10,498,599.31 (C/. IGV.)

Fórmula	Presupuesto		Avance Acumulado Anterior		Avance Actual		Avance Acumulado Actual		Saldo por Ejecutar		
	Descripción	Monto Total	Valorizado	%	Valorizado	%	Valorizado	%	Valorizado	%	
	Obra a Precios unitarios										
01	VALORIZACIÓN N° 18 DEL 01 AL 28 DE FEBRERO DEL 2019 (PRECIOS UNITARIOS)	8,897,118.06	3,307,536.97	37.18%	178,769.65	2.01%	3,486,306.62	39.18%	5,410,811.44	60.82%	
	Sub Total Presupuesto (S/. IGV)	8,897,118.06	3,307,536.97	37.18%	178,769.65	2.01%	3,486,306.62	39.18%	5,410,811.44	60.82%	

FORMULA POLINÓMICA N° 02: **EDIFICIO EN TIERRA ESTRUCTURA**

Valorización N°:	18
Fecha:	sáb 02 Mar 2019
Monto Contrato:	S/. 3,691,408.51 (S/. IGV.) S/. 4,355,862.04 (C/. IGV.)

Fórmula	Presupuesto		Avance Acumulado Anterior		Avance Actual		Avance Acumulado Actual		Saldo por Ejecutar	
	Descripción	Monto Total	Valorizado	%	Valorizado	%	Valorizado	%	Valorizado	%
01	VALORIZACIÓN N° 18 DEL 01 AL 28 DE FEBRERO DEL 2019 (PRECIOS UNITARIOS)	3,532,361.09	2,834,424.52	80.24%	17,206.86	0.49%	2,851,631.38	80.73%	680,729.71	19.27%
	Sub Total Presupuesto (S/. IGV)	3,532,361.09	2,834,424.52	80.24%	17,206.86	0.49%	2,851,631.38	80.73%	680,729.71	19.27%

FORMULA POLINÓMICA N° 03: **EDIFICIO EN TIERRA ARQUITECTURA**

Valorización N°:	18
Fecha:	sáb 02 Mar 2019
Monto Contrato:	S/. 1,738,221.23 (S/. IGV.) S/. 2,051,101.06 (C/. IGV.)

Fórmula	Presupuesto		Avance Acumulado Anterior		Avance Actual		Avance Acumulado Actual		Saldo por Ejecutar		
	Descripción	Monto Total	Valorizado	%	Valorizado	%	Valorizado	%	Valorizado	%	
	Obra a Precios unitarios										
01	VALORIZACIÓN N° 18 DEL 01 AL 28 DE FEBRERO DEL 2019 (PRECIOS UNITARIOS)	1,738,221.23	566,042.54	32.56%	77,103.98	4.44%	643,146.52	37.00%	1,095,074.71	63.00%	
	Sub Total Presupuesto (S/. IGV)	1,738,221.23	566,042.54	32.56%	77,103.98	4.44%	643,146.52	37.00%	1,095,074.71	63.00%	

 LUDWING CARRASCO BUSTAMANTE
 Ing. Supervisor - CIP 79040
 CESEL S.A.

800000



**VALORIZACIÓN N° 18 DEL 01 AL 28 DE FEBRERO DEL 2019
(PRECIOS UNITARIOS)**

Contrato N° 025-2017- FONDEPES Ejecución de la Obra: MEJORAMIENTO DE LOS SERVICIOS DEL DESEMBARCADERO PESQUERO ARTESANAL DE SUPE, REGION LIMA, PROVINCIA DE BARRANCA, DISTRITO DE SUPE PUERTO



OBRA: MEJORAMIENTO DE LOS SERVICIOS DEL DESEMBARCADERO PESQUERO ARTESANAL DE SUPE ,REGION LIMA, PROVINCIA DE BARRANCA, DISTRITO DE SUPE PUERTO
 PROP. FONDEPES
 CONT. CONSORCIO MARITIMO DEL NORTE
 SUP. CESEL
FORMULA POLINÓMICA N° 04:

EDIFICIO EN TIERRA INSTALACIONES ELECTRICAS

Valorización N°:	18
Fecha:	sáb 02 Mar 2019
Monto Contrato:	S/. 653,003.57 (S/. IGV.) S/. 770,544.21 (C/. IGV.)

Fórmula	Presupuesto		Avance Acumulado Anterior		Avance Actual		Avance Acumulado Actual		Saldo por Ejecutar		
	Descripción	Monto Total	Valorizado	%	Valorizado	%	Valorizado	%	Valorizado	%	
	Obra a Precios unitarios										
01	VALORIZACIÓN N° 18 DEL 01 AL 28 DE FEBRERO DEL 2019 (PRECIOS UNITARIOS)	158,866.47	35,414.48	22.29%	0.00	0.00%	35,414.48	22.29%	123,451.99	77.71%	
	Sub Total Presupuesto (S/. IGV)	158,866.47	35,414.48	22.29%	0.00	0.00%	35,414.48	22.29%	123,451.99	77.71%	

FORMULA POLINÓMICA N° 05:

EDIFICIO EN TIERRA INSTALACIONES SANITARIAS

Valorización N°:	18
Fecha:	sáb 02 Mar 2019
Monto Contrato:	S/. 820,930.60 (S/. IGV.) S/. 968,698.10 (C/. IGV.)

Fórmula	Presupuesto		Avance Acumulado Anterior		Avance Actual		Avance Acumulado Actual		Saldo por Ejecutar		
	Descripción	Monto Total	Valorizado	%	Valorizado	%	Valorizado	%	Valorizado	%	
	Obra a Precios unitarios										
01	VALORIZACIÓN N° 18 DEL 01 AL 28 DE FEBRERO DEL 2019 (PRECIOS UNITARIOS)	634,311.98	107,418.45	16.93%	-8,217.99	-1.30%	99,200.46	15.64%	535,111.51	84.36%	
	Sub Total Presupuesto (S/. IGV)	634,311.98	107,418.45	16.93%	-8,217.99	-1.30%	99,200.46	15.64%	535,111.51	84.36%	

FORMULA POLINÓMICA N° 06:

EDIFICIO EN TIERRA EQUIPAMIENTO

Valorización N°:	18
Fecha:	sáb 02 Mar 2019
Monto Contrato:	S/. 2,373,404.06 (S/. IGV.) S/. 2,800,616.79 (C/. IGV.)

Fórmula	Presupuesto		Avance Acumulado Anterior		Avance Actual		Avance Acumulado Actual		Saldo por Ejecutar		
	Descripción	Monto Total	Valorizado	%	Valorizado	%	Valorizado	%	Valorizado	%	
	Obra a Precios unitarios										
01	VALORIZACIÓN N° 18 DEL 01 AL 28 DE FEBRERO DEL 2019 (PRECIOS UNITARIOS)	2,373,404.06	1,378,948.60	58.10%	0.00	0.00%	1,378,948.60	58.10%	994,455.45	41.90%	
	Sub Total Presupuesto (S/. IGV)	2,373,404.06	1,378,948.60	58.10%	0.00	0.00%	1,378,948.60	58.10%	994,455.45	41.90%	

LUDWING CARRASCO BUSTAMANTE
 Ing. Supervisor - CIP 79040
 CESEL S.A.

000027



VALORIZACIÓN N° 18 DEL 01 AL 28 DE FEBRERO DEL 2019
(PRECIOS UNITARIOS)

Contrato N° 025-2017- FONDEPES Ejecución de la Obra: MEJORAMIENTO DE LOS SERVICIOS DEL DESEMBARCADERO PESQUERO ARTESANAL DE SUPE, REGION LIMA, PROVINCIA DE BARRANCA, DISTRITO DE SUPE PUERTO



OBRA: MEJORAMIENTO DE LOS SERVICIOS DEL DESEMBARCADERO PESQUERO ARTESANAL DE SUPE ,REGION LIMA, PROVINCIA DE BARRANCA, DISTRITO DE SUPE PUERTO
 PROP. FONDEPES
 CONT. CONSORCIO MARITIMO DEL NORTE
 SUP. CESEL

FORMULA POLINÓMICA N° 07:

IMPACTO AMBIENTAL

Valorización N°:	18
Fecha:	sáb 02 Mar 2019
Monto Contrato:	S/. 53,957.61 (S/. IGV.) S/. 63,669.99 (C/. IGV.)

Fórmula	Presupuesto		Avance Acumulado Anterior		Avance Actual		Avance Acumulado Actual		Saldo por Ejecutar	
	Descripción	Monto Total	Valorizado	%	Valorizado	%	Valorizado	%	Valorizado	%
	Obra a Precios unitarios									
01	VALORIZACIÓN N° 18 DEL 01 AL 28 DE FEBRERO DEL 2019 (PRECIOS UNITARIOS)	53,957.61	38,064.34	70.54%	0.00	0.00%	38,064.34	70.54%	15,893.28	29.46%
	Sub Total Presupuesto (S/. IGV)	53,957.61	38,064.34	70.54%	0.00	0.00%	38,064.34	70.54%	15,893.28	29.46%

RESUMEN GENERAL DE PRESUPUESTOS

Valorización N°:	18
Fecha:	sáb 02 Mar 2019
Monto Contrato:	S/. 18,228,043.63 (S/. IGV.) S/. 21,509,091.49 (C/. IGV.)

PRESUPUESTO	Presupuesto		Avance Acumulado Anterior		Avance Actual		Avance Acumulado Actual		Saldo por Ejecutar	
	Descripción	Monto Total	Valorizado	%	Valorizado	%	Valorizado	%	Valorizado	%
	VALORIZACIÓN N° 18 DEL 01 AL 28 DE FEBRERO DEL 2019 (PRECIOS UNITARIOS)	16,083,952.44	8,267,849.90	51.40%	264,862.51	1.65%	8,532,712.41	53.05%	8,855,528.09	55.06%
	Sub Total Presupuesto (S/. IGV)	16,083,952.44	8,267,849.90	51.40%	264,862.51	1.65%	8,532,712.41	53.05%	8,855,528.09	55.06%

LUDWING CARRASCO BUSTAMANTE
 Ing. Supervisor - CIP 79040
 CESEL S.A.

920000



VALORIZACIÓN N° 18 DEL 01 AL 28 DE FEBRERO DEL 2019
(PRECIOS UNITARIOS)



Contrato N° 025-2017- FONDEPES Ejecucion de la Obra: MEJORAMIENTO DE LOS
SERVICIOS DEL DESEMBARCADERO PESQUERO ARTESANAL DE SUPE, REGION
LIMA, PROVINCIA DE BARRANCA, DISTRITO DE SUPE PUERTO



OBRA: MEJORAMIENTO DE LOS SERVICIOS DEL DESEMBARCADERO PESQUERO ARTESANAL DE SUPE ,REGION LIMA, PROVINCIA DE BARRANCA, DISTRITO DE SUPE PUERTO
PROP. FONDEPES
CONT. CONSORCIO MARITIMO DEL NORTE
SUP. CESEL

CUADRO DE AMORTIZACIONES

FORMULA POLINÓMICA N° 01:

OBRAS PORTUARIAS

Adelanto Directo- N° 01

Monto Contrato (S/I.G.V.)	Concepto	Monto Otorgado	Amortiz.Acum. Anterior		Amortización Actual		Amortiz Acum. Actual		Saldo por Amortizar	
			Amortizado	%	Amortizado	%	Amortizado	%	Monto	%
S/. 8,897,118.06	Adelanto Directo (10%)	S/. 889,711.81	S/. 337,806.01	37.97%	S/. 0.00	0.00%	S/. 337,806.01	37.97%	S/. 551,905.80	62.03%
Total Otorgado	Monto Contrato	S/. 889,711.81	S/. 337,806.01	37.97%	S/. 0.00	0.00%	S/. 337,806.01	37.97%	S/. 551,905.80	62.03%

FORMULA POLINÓMICA N° 02:

EDIFICIO EN TIERRA ESTRUCTURA

Adelanto Directo- N° 01

Monto Contrato (S/I.G.V.)	Concepto	Monto Otorgado	Amortiz.Acum. Anterior		Amortización Actual		Amortiz Acum. Actual		Saldo por Amortizar	
			Amortizado	%	Amortizado	%	Amortizado	%	Monto	%
S/. 3,691,408.51	Adelanto Directo (10%)	S/. 369,140.85	S/. 301,571.31	81.70%	S/. 4,059.47	1.10%	S/. 305,630.78	82.80%	S/. 63,510.07	17.20%
Total Otorgado	Monto Contrato	S/. 369,140.85	S/. 301,571.31	81.70%	S/. 4,059.47	1.10%	S/. 305,630.78	82.80%	S/. 63,510.07	17.20%

EDWIN CARRASCO BUSTAMANTE
Supervisor - CIP 79040
CESEL S.A.

000025



VALORIZACIÓN N° 18 DEL 01 AL 28 DE FEBRERO DEL 2019
(PRECIOS UNITARIOS)



Contrato N° 025-2017- FONDEPES Ejecucion de la Obra: MEJORAMIENTO DE LOS SERVICIOS DEL DESEMBARCADERO PESQUERO ARTESANAL DE SUPE, REGION LIMA, PROVINCIA DE BARRANCA, DISTRITO DE SUPE PUERTO



OBRA: MEJORAMIENTO DE LOS SERVICIOS DEL DESEMBARCADERO PESQUERO ARTESANAL DE SUPE ,REGION LIMA, PROVINCIA DE BARRANCA, DISTRITO DE SUPE PUERTO
PROP. FONDEPES
CONT. CONSORCIO MARITIMO DEL NORTE
SUP. CESEL

CUADRO DE AMORTIZACIONES

FORMULA POLINÓMICA N° 03:

EDIFICIO EN TIERRA ARQUITECTURA

Adelanto Directo- N° 01

Monto Contrato (S/I.G.V.)	Concepto	Monto Otorgado	Amortiz.Acum. Anterior		Amortización Actual		Amortiz Acum. Actual		Saldo por Amortizar	
			Amortizado	%	Amortizado	%	Amortizado	%	Monto	%
S/. 1,738,221.23	Adelanto Directo (10%)	S/. 173,822.12	S/. 54,732.15	31.49%	S/. 11,050.85	6.36%	S/. 65,783.00	37.85%	S/. 108,039.12	62.15%
Total Otorgado	Monto Contrato	S/. 173,822.12	S/. 54,732.15	31.49%	S/. 11,050.85	6.36%	S/. 65,783.00	37.85%	S/. 108,039.12	62.15%

FORMULA POLINÓMICA N° 04:

EDIFICIO EN TIERRA INSTALACIONES ELECTRICAS

Adelanto Directo- N° 01

Monto Contrato (S/I.G.V.)	Concepto	Monto Otorgado	Amortiz.Acum. Anterior		Amortización Actual		Amortiz Acum. Actual		Saldo por Amortizar	
			Amortizado	%	Amortizado	%	Amortizado	%	Monto	%
S/. 653,003.57	Adelanto Directo (10%)	S/. 65,300.36	S/. 3,656.14	5.60%	S/. 342.77	0.52%	S/. 3,998.91	6.12%	S/. 61,301.45	93.88%
Total Otorgado	Monto Contrato	S/. 65,300.36	S/. 3,656.14	5.60%	S/. 342.77	0.52%	S/. 3,998.91	6.12%	S/. 61,301.45	93.88%

FORMULA POLINÓMICA N° 05:

EDIFICIO EN TIERRA INSTALACIONES SANITARIAS

Adelanto Directo- N° 01

Monto Contrato (S/I.G.V.)	Concepto	Monto Otorgado	Amortiz.Acum. Anterior		Amortización Actual		Amortiz Acum. Actual		Saldo por Amortizar	
			Amortizado	%	Amortizado	%	Amortizado	%	Monto	%
S/. 820,930.60	Adelanto Directo (10%)	S/. 82,093.06	S/. 12,580.87	15.33%	S/. 134.63	0.16%	S/. 12,715.50	15.49%	S/. 69,377.56	84.51%
Total Otorgado	Monto Contrato	S/. 82,093.06	S/. 12,580.87	15.33%	S/. 134.63	0.16%	S/. 12,715.50	15.49%	S/. 69,377.56	84.51%

UDWING CARRASCO BUSTAMANTE
Ing. Supervisor - CIP 79040
CESEL S.A.

720000



VALORIZACIÓN N° 18 DEL 01 AL 28 DE FEBRERO DEL 2019
(PRECIOS UNITARIOS)



Contrato N° 025-2017- FONDEPES Ejecucion de la Obra: MEJORAMIENTO DE LOS SERVICIOS DEL DESEMBARCADERO PESQUERO ARTESANAL DE SUPE, REGION LIMA, PROVINCIA DE BARRANCA, DISTRITO DE SUPE PUERTO



OBRA: MEJORAMIENTO DE LOS SERVICIOS DEL DESEMBARCADERO PESQUERO ARTESANAL DE SUPE ,REGION LIMA, PROVINCIA DE BARRANCA, DISTRITO DE SUPE PUERTO
PROP. FONDEPES
CONT. CONSORCIO MARITIMO DEL NORTE
SUP. CESEL

CUADRO DE AMORTIZACIONES
EDIFICIO EN TIERRA EQUIPAMIENTO

FORMULA POLINÓMICA N° 06:

Adelanto Directo- N° 01

Monto Contrato (S/I.G.V.)	Concepto	Monto Otorgado	Amortiz.Acum. Anterior		Amortización Actual		Amortiz Acum. Actual		Saldo por Amortizar	
			Amortizado	%	Amortizado	%	Amortizado	%	Monto	%
S/. 2,373,404.06	Adelanto Directo (10%)	S/. 237,340.41	S/. 154,993.82	65.30%	S/. 0.00	0.00%	S/. 154,993.82	65.30%	S/. 82,346.59	34.70%
Total Otorgado	Monto Contrato	S/. 237,340.41	S/. 154,993.82	65.30%	S/. 0.00	0.00%	S/. 154,993.82	65.30%	S/. 82,346.59	34.70%

FORMULA POLINÓMICA N° 07:

IMPACTO AMBIENTAL

Adelanto Directo- N° 01

Monto Contrato (S/I.G.V.)	Concepto	Monto Otorgado	Amortiz.Acum. Anterior		Amortización Actual		Amortiz Acum. Actual		Saldo por Amortizar	
			Amortizado	%	Amortizado	%	Amortizado	%	Monto	%
S/. 53,957.61	Adelanto Directo (10%)	S/. 5,395.76	S/. 3,996.79	74.07%	S/. 0.00	0.00%	S/. 3,996.79	74.07%	S/. 1,398.97	25.93%
Total Otorgado	Monto Contrato	S/. 5,395.76	S/. 3,996.79	74.07%	S/. 0.00	0.00%	S/. 3,996.79	74.07%	S/. 1,398.97	25.93%

LUDWING CATRASCO BUSTAMANTE
Ing. Supervisor - CIP 78040
CESEL S.A.

000033



VALORIZACIÓN N° 18 DEL 01 AL 28 DE FEBRERO DEL 201
(PRECIOS UNITARIOS)



Contrato N° 025-2017- FONDEPES Ejecución de la Obra: MEJORAMIENTO DE LOS SERVICIOS DEL DESEMBARCADERO PESQUERO ARTESANAL DE SUPE, REGION LIMA, PROVINCIA DE BARRANCA, DISTRITO DE SUPE PUERTO



OBRA: MEJORAMIENTO DE LOS SERVICIOS DEL DESEMBARCADERO PESQUERO ARTESANAL DE SUPE ,REGION LIMA, PROVINCIA DE BARRANCA, DISTRITO DE SUPE PUERTO
PROP. FONDEPES
CONT. CONSORCIO MARITIMO DEL NORTE
SUP. CESEL

FORMULA POLINÓMICA N° 01:

AMORTIZACIÓN Y DEDUCCIÓN DEL ADELANTO DIRECTO - N° 01

OBRAS PORTUARIAS

Monto Adelanto Directo (Sin I.G.V.): S/. 1,103,242.64
Fecha de Pago: Ago-2017

A/C= 12.40%

Monto Contratado (Sin I.G.V.): 8,897,118.06
Monto Adelanto Directo asignado (Sin I.G.V.): S/. 889,711.81

N°	Valorización		Amortización en el mes (2) = (1)*(A/C)	Deuda al Mes Anterior (3)	Saldo al Mes (3) - (2)	"K" del Mes		"K" al Pago (AGOSTO 2017)	Coeficiente	Deducción Adelanto Directo N° 01
	Mes	Monto Total (1)				Mes	K			
01	Set-17	106,436.31	10,643.63	889,711.81	879,068.18	Ago-17	1.0215	1.0215	0.0000	0.00
02	Oct-17	844,357.40	84,435.74	879,068.18	794,632.44	Set-17	1.025	1.0215	0.0037	316.20
03	Nov-17	392,242.78	39,224.28	794,632.44	755,408.16	Oct-17	1.024	1.0215	0.0028	109.15
04	Dic-17	1,187,259.48	118,725.95	755,408.16	636,682.21	Nov-17	1.021	1.0215	-0.0003	-36.70
05	Ene-18	328,038.47	36,871.52	636,682.21	599,810.69	Dic-17	1.026	1.0215	0.0040	125.76
06	Feb-18	153,293.00	17,230.13	599,810.69	582,580.56	Ene-18	1.0268	1.0215	0.0052	89.58
07	Mar-18	-75,269.47	-8,460.29	582,580.56	591,040.85	Feb-18	1.0488	1.0215	0.0268	-226.43
08	Abr-18	29,558.99	3,322.43	591,040.85	587,718.42	Mar-18	1.0535	1.0215	0.0314	104.20
09	May-18	21,343.47	2,399.01	587,718.42	585,319.41	Abr-18	1.0504	1.0215	0.0283	67.89
10	Jun-18	87,013.77	9,780.35	585,319.41	575,539.06	May-18	1.0613	1.0215	0.0390	381.38
11	Jul-18	47,706.78	5,362.24	575,539.06	570,176.82	Jun-18	1.0588	1.0215	0.0366	196.12
12	Ago-18	20,567.19	2,311.75	570,176.82	567,865.07	Jul-18	1.0612	1.0215	0.0389	89.87
13	Set-18	0.00	0.00	567,865.07	567,865.07	Ago-18	1.0764	1.0215	0.0537	0.00
14	Oct-18	0.00	0.00	567,865.07	567,865.07	Set-18	1.0811	1.0215	0.0584	0.00
15	Nov-18	110,459.82	13,211.00	567,865.07	554,654.07	Oct-18	1.0827	1.0215	0.0599	791.79
16	Dic-18	22,978.88	2,748.27	554,654.07	551,905.80	Nov-18	1.0842	1.0215	0.0614	168.63
17	Ene-19	0.00	0.00	551,905.80	551,905.80	Dic-18	1.0895	1.0215	0.0666	0.00
18	Feb-19	178,769.65	22,167.44	551,905.80	529,738.36	Ene-19	1.0853	1.0215	0.0625	1,385.42
Total		3,454,756.53	359,973.45							3,562.84

(*) : IU conocido hasta el momento

Acumulado Total	3,562.84
Acumulado Anterior	2,177.42
Deducción del mes	1,385.42

Amortización Actual (Febrero 2019)

22,167.44

Deducción Actual (Febrero 2019)

1,385.42

LUDWIG CAJASCO BUSTAMANTE
Ing. Supervisor - CIP 79040
CESEL S.A.

0000032



VALORIZACIÓN N° 18 DEL 01 AL 28 DE FEBRERO DEL 201
(PRECIOS UNITARIOS)



Contrato N° 025-2017- FONDEPES Ejecución de la Obra: MEJORAMIENTO DE LOS SERVICIOS DEL DESEMBARCADERO PESQUERO ARTESANAL DE SUPE, REGION LIMA, PROVINCIA DE BARRANCA, DISTRITO DE SUPE PUERTO



OBRA: MEJORAMIENTO DE LOS SERVICIOS DEL DESEMBARCADERO PESQUERO ARTESANAL DE SUPE ,REGION LIMA, PROVINCIA DE BARRANCA, DISTRITO DE SUPE PUERTO
PROP. FONDEPES
CONT. CONSORCIO MARITIMO DEL NORTE
SUP. CESEL

FORMULA POLINÓMICA N° 02:

AMORTIZACIÓN Y DEDUCCIÓN DEL ADELANTO DIRECTO - N° 01

EDIFICIO EN TIERRA ESTRUCTURA

Monto Adelanto Directo (Sin I.G.V.): S/. 457,734.65
Fecha de Pago: Ago-2017

A/C= 12.40%

Monto Contratado (Sin I.G.V.): S/. 3,691,408.51
Monto Adelanto Directo asignado (Sin I.G.V.): S/. 369,140.85

N°	Valorización		Amortización en el mes (2) = (1)*(A/C)	Deuda (3)	Saldo al Mes (3) - (2)	"K" del Mes		"K" al Pago (AGOSTO 2017)	Coeficiente	Deducción Adelanto Directo N° 01
	Mes	Monto Total (1)				Mes	K			
01	Set-17	119,395.59	11,939.56	369,140.85	357,201.29	Ago-17	1.015	1.015	0.0000	0.00
02	Oct-17	157,933.71	15,793.37	357,201.29	341,407.92	Set-17	1.017	1.015	0.0022	34.08
03	Nov-17	857,570.31	85,757.03	341,407.92	255,650.89	Oct-17	1.017	1.015	0.0025	218.54
04	Dic-17	138,517.05	13,851.71	255,650.89	241,799.18	Nov-17	1.015	1.015	0.0006	9.00
05	Ene-18	53,320.73	5,993.25	241,799.18	235,805.93	Dic-17	1.017	1.015	0.0027	16.21
06	Feb-18	253,267.64	28,467.28	235,805.93	207,338.65	Ene-18	1.020	1.015	0.0052	146.83
07	Mar-18	246,884.19	27,749.78	207,338.65	179,588.87	Feb-18	1.041	1.015	0.0260	720.49
08	Abr-18	51,812.01	5,823.67	179,588.87	173,765.20	Mar-18	1.044	1.015	0.0286	166.62
09	May-18	121,196.47	13,622.48	173,765.20	160,142.72	Abr-18	1.039	1.015	0.0243	330.62
10	Jun-18	134,191.86	15,083.17	160,142.72	145,059.55	May-18	1.046	1.015	0.0305	460.23
11	Jul-18	198,055.29	22,261.41	145,059.55	122,798.14	Jun-18	1.044	1.015	0.0292	649.47
12	Ago-18	104,581.60	11,754.97	122,798.14	111,043.17	Jul-18	1.046	1.015	0.0306	360.12
13	Set-18	10,478.58	1,230.18	111,043.17	109,812.99	Ago-18	1.059	1.015	0.0441	54.29
14	Oct-18	69,354.83	8,142.26	109,812.99	101,670.73	Set-18	1.061	1.015	0.0459	373.64
15	Nov-18	13,937.26	1,666.90	101,670.73	100,003.83	Oct-18	1.063	1.015	0.0481	70.25
16	Dic-18	271,189.75	32,434.29	100,003.83	67,569.54	Nov-18	1.065	1.015	0.0500	1,621.12
17	Ene-19	32,737.65	4,059.47	67,569.54	63,510.07	Dic-18	1.069	1.015	0.0532	215.79
18	Feb-19	17,206.86	2,133.65	63,510.07	61,376.42	Ene-19	1.066	1.015	0.0503	107.30
Total		2,851,631.38	307,764.43							5,554.60

(*) : IU conocido hasta el momento

Acumulado Total	5,554.60
Acumulado Anterior	5,447.30
Deducción del mes	107.30

Amortización Actual (Febrero 2019)

2,133.65

Deducción Actual (Febrero 2019)

107.30

LUDWING CARRASCO BUSTAMANTE
Ing. Supervisor - CIP 79040
CESEL S.A.

1000031



VALORIZACIÓN N° 18 DEL 01 AL 28 DE FEBRERO DEL 201
(PRECIOS UNITARIOS)



Contrato N° 025-2017- FONDEPES Ejecución de la Obra: MEJORAMIENTO DE LOS SERVICIOS DEL DESEMBARCADERO PESQUERO ARTESANAL DE SUPE, REGION LIMA, PROVINCIA DE BARRANCA, DISTRITO DE SUPE PUERTO



OBRA: MEJORAMIENTO DE LOS SERVICIOS DEL DESEMBARCADERO PESQUERO ARTESANAL DE SUPE ,REGION LIMA, PROVINCIA DE BARRANCA, DISTRITO DE SUPE PUERTO
PROP. FONDEPES
CONT. CONSORCIO MARITIMO DEL NORTE
SUP. CESEL

FORMULA POLINÓMICA N° 03:

AMORTIZACIÓN Y DEDUCCIÓN DEL ADELANTO DIRECTO - N° 01

EDIFICIO EN TIERRA ARQUITECTURA

Monto Adelanto Directo (Sin I.G.V.): S/. 215,539.43
Fecha de Pago: Ago-2017

A/C= 12.40%

Monto Contratado (Sin I.G.V.): S/. 1,738,221.23
Monto Adelanto Directo asignado (Sin I.G.V.): S/. 173,622.12

N°	Valorización		Amortización en el mes (2) = (1)*(A/C)	Deuda (3)	Saldo al Mes (3) - (2)	"K" del Mes		"K" al Pago (AGOSTO 2017)	Coeficiente	Deducción Adelanto Directo N° 01
	Mes	Monto Total (1)				Mes	K			
01	Set-17	0.00	0.00	215,539.43	215,539.43	Ago-17	1.0193	1.019	0.0000	0.00
02	Oct-17	0.00	0.00	215,539.43	215,539.43	Set-17	1.0226	1.019	0.0032	0.00
03	Nov-17	0.00	0.00	215,539.43	215,539.43	Oct-17	0.0000	1.019	-1.0000	0.00
04	Dic-17	0.00	0.00	215,539.43	215,539.43	Nov-17	0.0000	1.019	-1.0000	0.00
05	Ene-18	0.00	0.00	215,539.43	215,539.43	Dic-17	0.0000	1.019	-1.0000	0.00
06	Feb-18	31,040.65	3,488.97	215,539.43	212,050.46	Ene-18	1.0488	1.019	0.0289	100.98
07	Mar-18	14,566.07	1,637.23	212,050.46	210,413.24	Feb-18	1.0705	1.019	0.0502	82.20
08	Abr-18	36,673.40	4,122.09	210,413.24	206,291.15	Mar-18	1.0721	1.019	0.0517	213.23
09	May-18	18,730.19	2,105.27	206,291.15	204,185.87	Abr-18	1.0458	1.019	0.0260	54.73
10	Jun-18	51,186.57	5,753.37	204,185.87	198,432.50	May-18	1.0507	1.019	0.0308	177.35
11	Jul-18	49,037.86	5,511.86	198,432.50	192,920.65	Jun-18	1.0510	1.019	0.0310	171.03
12	Ago-18	87,261.74	9,808.22	192,920.65	183,112.43	Jul-18	1.0518	1.019	0.0319	312.94
13	Set-18	34,748.19	4,079.44	183,112.43	179,032.99	Ago-18	1.0715	1.019	0.0512	208.85
14	Oct-18	70,095.06	8,229.16	179,032.99	170,803.83	Set-18	1.0737	1.019	0.0533	438.83
15	Nov-18	76,668.78	9,169.59	170,803.83	161,634.24	Oct-18	1.0762	1.019	0.0558	511.41
16	Dic-18	6,914.26	826.95	161,634.24	160,807.29	Nov-18	1.0791	1.019	0.0586	48.48
17	Ene-19	89,119.77	11,050.89	160,807.29	149,756.44	Dic-18	1.0792	1.019	0.0588	649.39
18	Feb-19	77,103.98	9,560.89	149,756.44	140,195.54	Ene-19	1.0751	1.019	0.0547	522.92
Total		643,146.53	75,343.89							3,492.34

(*) : IU conocido hasta el momento

Acumulado Total	3,492.34
Acumulado Anterior	2,969.42
Deducción del mes	522.92

Amortización Actual (Febrero 2019)

9,560.89

Deducción Actual (Febrero 2019)

522.92

LUDWING CARRASCO BUSTAMANTE
Ing. Supervisor - CIP 79040
CESEL S.A.

0000030



VALORIZACIÓN N° 18 DEL 01 AL 28 DE FEBRERO DEL 201
(PRECIOS UNITARIOS)



Contrato N° 025-2017- FONDEPES Ejecución de la Obra: MEJORAMIENTO DE LOS SERVICIOS DEL DESEMBARCADERO PESQUERO ARTESANAL DE SUPE, REGION LIMA, PROVINCIA DE BARRANCA, DISTRITO DE SUPE PUERTO



OBRA: MEJORAMIENTO DE LOS SERVICIOS DEL DESEMBARCADERO PESQUERO ARTESANAL DE SUPE, REGION LIMA, PROVINCIA DE BARRANCA, DISTRITO DE SUPE PUERTO
PROP. FONDEPES
CONT. CONSORCIO MARITIMO DEL NORTE
SUP. CESEL

FORMULA POLINÓMICA N° 04:

AMORTIZACIÓN Y DEDUCCIÓN DEL ADELANTO DIRECTO - N° 01

Edificio en tierra instalaciones eléctricas

Monto Adelanto Directo (Sin I.G.V.): S/. 80,972.44
Fecha de Pago: Ago-2017

Monto Contratado (Sin I.G.V.): S/. 653,003.57
Monto Adelanto Directo asignado (Sin I.G.V.): S/. 65,300.36

A/C= 12.40%

N°	Valorización		Amortización en el mes (2) = (1)*(A/C)	Deuda (3)	Saldo al Mes (3) - (2)	"K" del Mes		"K" al Pago (AGOSTO 2017)	Coeficiente	Deducción Adelanto Directo N° 01
	Mes	Monto Total (1)				Mes	K			
01	Set-17	0.00	0.00	80,972.44	80,972.44	Ago-17	0.9184	1.0152	-0.0954	0.00
02	Oct-17	0.00	0.00	80,972.44	80,972.44	Set-17	0.9299	1.0152	-0.0840	0.00
03	Nov-17	0.00	0.00	80,972.44	80,972.44	Oct-17	0.0000	1.0152	-1.0000	0.00
04	Dic-17	0.00	0.00	80,972.44	80,972.44	Nov-17	0.0000	1.0152	-1.0000	0.00
05	Ene-18	0.00	0.00	80,972.44	80,972.44	Dic-17	0.0000	1.0152	-1.0000	0.00
06	Feb-18	0.00	0.00	80,972.44	80,972.44	Ene-18	0.0000	1.0152	-1.0000	0.00
07	Mar-18	7,886.62	886.46	80,972.44	80,085.98	Feb-18	0.9432	1.0152	-0.0709	-62.87
08	Abr-18	11,492.27	1,291.73	80,085.98	78,794.25	Mar-18	0.9445	1.0152	-0.0697	-90.01
09	May-18	10,808.63	1,214.89	78,794.25	77,579.36	Abr-18	0.9439	1.0152	-0.0703	-85.38
10	Jun-18	0.00	0.00	77,579.36	77,579.36	May-18	0.9515	1.0152	-0.0628	0.00
11	Jul-18	5,540.78	622.78	77,579.36	76,956.58	Jun-18	0.9543	1.0152	-0.0600	-37.38
12	Ago-18	-330.60	-37.16	76,956.58	76,993.74	Jul-18	0.9541	1.0152	-0.0602	2.24
13	Set-18	327.98	38.50	76,993.74	76,955.24	Ago-18	0.9613	1.0152	-0.0531	22.10
14	Oct-18	-3,075.48	-361.06	76,955.24	77,316.30	Set-18	0.9623	1.0152	-0.0522	23.17
15	Nov-18	0.00	0.00	77,316.30	77,316.30	Oct-18	0.9666	1.0152	-0.0479	0.00
16	Dic-18	0.00	0.00	77,316.30	77,316.30	Nov-18	0.9678	1.0152	-0.0467	0.00
17	Ene-19	2,764.29	342.77	77,316.30	76,973.53	Dic-18	0.9713	1.0152	-0.0433	-14.84
18	Feb-19	0.00	0.00	76,973.53	76,973.53	Ene-19	0.9700	1.0152	-0.0445	0.00
Total		35,414.48	3,998.91							-242.97

(*) : IU conocido hasta el momento

Acumulado Total	-242.97
Acumulado Anterior	-242.97
Deducción del mes	0.00

Amortización Actual (Febrero 2019)

0.00

Deducción Actual (Febrero 2019)

0.00

LUDWING CARRASCO BUSTAMANTE
Ing. Supervisor - CIP 79040
CESEL S.A.

nnnn99



VALORIZACIÓN N° 18 DEL 01 AL 28 DE FEBRERO DEL 201
(PRECIOS UNITARIOS)



Contrato N° 025-2017- FONDEPES Ejecución de la Obra: MEJORAMIENTO DE LOS SERVICIOS DEL DESEMBARCADERO PESQUERO ARTESANAL DE SUPE, REGION LIMA, PROVINCIA DE BARRANCA, DISTRITO DE SUPE PUERTO



OBRA: MEJORAMIENTO DE LOS SERVICIOS DEL DESEMBARCADERO PESQUERO ARTESANAL DE SUPE ,REGION LIMA, PROVINCIA DE BARRANCA, DISTRITO DE SUPE PUERTO
 PROP. FONDEPES
 CONT. CONSORCIO MARITIMO DEL NORTE
 SUP. CESEL
 FORMULA POLINÓMICA N° 05:

AMORTIZACIÓN Y DEDUCCIÓN DEL ADELANTO DIRECTO - N° 01

EDIFICIO EN TIERRA INSTALACIONES SANITARIAS
 Monto Adelanto Directo (Sin I.G.V.): S/. 101,795.39
 Fecha de Pago: Ago-2017

A/C= 12.40%

Monto Contratado (Sin I.G.V.): S/. 820,930.60
 Monto Adelanto Directo asignado (Sin I.G.V.): S/. 82,093.06

N°	Valorización		Amortización en el mes (2) = (1)*A/C	Deuda (3)	Saldo al Mes (3) - (2)	"K" del Mes		"K" al Pago (AGOSTO 2017)	Coeficiente	Deducción Adelanto Directo N° 01
	Mes	Monto Total (1)				Mes	K			
01	Set-17	0.00	0.00	101,795.39	101,795.39	Ago-17	1.1389	1.006	0.1326	0.00
02	Oct-17	0.00	0.00	101,795.39	101,795.39	Set-17	1.1396	1.006	0.1322	0.00
03	Nov-17	0.00	0.00	101,795.39	101,795.39	Oct-17	0.0000	1.006	-1.0000	0.00
04	Dic-17	0.00	0.00	101,795.39	101,795.39	Nov-17	0.0000	1.006	-1.0000	0.00
05	Ene-18	0.00	0.00	101,795.39	101,795.39	Dic-17	0.0000	1.006	-1.0000	0.00
06	Feb-18	0.00	0.00	101,795.39	101,795.39	Ene-18	0.0000	1.006	-1.0000	0.00
07	Mar-18	4,508.32	506.74	101,795.39	101,288.65	Feb-18	1.1503	1.006	0.1439	72.94
08	Abr-18	0.00	0.00	101,288.65	101,288.65	Mar-18	1.1544	1.006	0.1480	0.00
09	May-18	8,359.00	939.55	101,288.65	100,349.10	Abr-18	1.1543	1.006	0.1480	139.04
10	Jun-18	0.00	0.00	100,349.10	100,349.10	May-18	1.1600	1.006	0.1537	0.00
11	Jul-18	3,876.38	435.71	100,349.10	99,913.39	Jun-18	1.1617	1.006	0.1553	67.68
12	Ago-18	908.49	102.11	99,913.39	99,811.28	Jul-18	1.1625	1.006	0.1561	15.94
13	Set-18	0.00	0.00	99,811.28	99,811.28	Ago-18	1.1789	1.006	0.1724	-79.13
14	Oct-18	4,289.91	503.64	99,811.28	99,307.64	Set-18	1.1823	1.006	0.1758	84.01
15	Nov-18	0.00	0.00	99,307.64	99,307.64	Oct-18	1.1831	1.006	0.1766	0.00
16	Dic-18	84,390.65	10,093.12	99,307.64	89,214.52	Nov-18	1.1851	1.006	0.1786	1,802.22
17	Ene-19	1,085.71	134.63	89,214.52	89,079.90	Dic-18	1.1817	1.006	0.1752	23.59
18	Feb-19	-8,217.99	-1,019.03	89,079.90	90,098.93	Ene-19	1.1781	1.006	0.1716	-174.87
Total		99,200.47	11,696.47							1,951.42

(*) : IU conocido hasta el momento

Acumulado Total	1,951.42
Acumulado Anterior	2,126.29
Deducción del mes	-174.87

Amortización Actual (Febrero 2019)

-1,019.03

Deducción Actual (Febrero 2019)

174.87

LUDWING CARRASCO BUSTAMANTE
 Ing. Supervisor - CIP 79040
 CESEL S.A.

800000



VALORIZACIÓN N° 18 DEL 01 AL 28 DE FEBRERO DEL 201
(PRECIOS UNITARIOS)



Contrato N° 025-2017- FONDEPES Ejecucion de la Obra: MEJORAMIENTO DE LOS SERVICIOS DEL DESEMBARCADERO PESQUERO ARTESANAL DE SUPE, REGION LIMA, PROVINCIA DE BARRANCA, DISTRITO DE SUPE PUERTO



OBRA: MEJORAMIENTO DE LOS SERVICIOS DEL DESEMBARCADERO PESQUERO ARTESANAL DE SUPE ,REGION LIMA, PROVINCIA DE BARRANCA, DISTRITO DE SUPE PUERTO
PROP. FONDEPES
CONT. CONSORCIO MARITIMO DEL NORTE
SUP. CESEL

FORMULA POLINÓMICA N° 06:

AMORTIZACIÓN Y DEDUCCIÓN DEL ADELANTO DIRECTO - N° 01

EDIFICIO EN TIERRA EQUIPAMIENTO

Monto Adelanto Directo (Sin I.G.V.): S/. 294,302.10
Fecha de Pago: Ago-2017

Monto Contratado (Sin I.G.V.): S/. 2,373,404.06
Monto Adelanto Directo asignado (Sin I.G.V.): S/. 237,340.41

A/C= 12.40%

N°	Valorización		Amortización en el mes (2) = (1)*(A/C)	Deuda (3)	Saldo al Mes (3) - (2)	"K" del Mes		"K" al Pago (AGOSTO 2017)	Coeficiente	Deducción Adelanto Directo N° 01
	Mes	Monto Total (1)				Mes	K			
01	Set-17									
02	Oct-17									
03	Nov-17									
04	Dic-17									
05	Ene-18									
06	Feb-18									
07	Mar-18									
08	Abr-18									
09	May-18									
10	Jun-18	0.00	0.00	237340.41	237340.058	May-18	1.01755772	0.994992372	0.0227	0.00
11	Jul-18	0.00	0.00	237341.41	237340.058	Jun-18	1.01755772	0.994992372	0.0227	0.00
12	Ago-18	1,378,948.60	154,993.82	237341.41	237340.058	Jul-18	1.02132405	0.994992372	0.0255	4,101.79
13	Set-18	0.00	0.00	237341.41	237340.058	Ago-18	1.02942566	0.994992372	0.0346	0.00
14	Oct-18	0.00	0.00	237341.41	237340.058	Set-18	1.03800019	0.994992372	0.0432	0.00
15	Nov-18	0.00	0.00	237341.41	237340.058	Oct-18	1.04635497	0.994992372	0.0516	0.00
16	Dic-18	0.00	0.00	237341.41	237340.058	Nov-18	1.05970395	0.994992372	0.0650	0.00
17	Ene-19	0.00	0.00	237341.41	237340.058	Dic-18	1.05935838	0.994992372	0.0647	0.00
18	Feb-19	0.00	0.00					0.994992372	1.0545	0.00
Total		1,378,948.60	154,993.82							4,101.79

(*) : IU conocido hasta el momento

Acumulado Total	4,101.79
Acumulado Anterior	4,101.79
Deducción del mes	0.00

Amortización Actual (Febrero 2019)

0.00

Deducción Actual (Febrero 2019)

0.00

LUDWIG CARRASCO BUSTAMANTE
Ing. Supervisor - CIP 79040
CESEL S.A.

000007



VALORIZACIÓN N° 18 DEL 01 AL 29 DE FEBRERO DEL 201
(PRECIOS UNITARIOS)



Contrato N° 025-2017- FONDEPES Ejecución de la Obra: MEJORAMIENTO DE LOS SERVICIOS DEL DESEMBAICADERO PESQUERO ARTESANAL DE SUPE, REGION LIMA, PROVINCIA DE BARRANCA, DISTRITO DE SUPE PUERTO



ORBA: MEJORAMIENTO DE LOS SERVICIOS DEL DESEMBAICADERO PESQUERO ARTESANAL DE SUPE, REGION LIMA, PROVINCIA DE BARRANCA, DISTRITO DE SUPE PUERTO
PROP: FONDEPES
CONT: CONSORCIO MARTINO DEL MORTE
SUP: CESEL

FORMULA POLINÓMICA N° 07:

IMPACTO AMBIENTAL

AMORTIZACIÓN Y DEDUCCIÓN DEL ADELANTO DIRECTO - N° 01

Monto Adelanto Directo (Sin I.G.V.): S/. 6,690.74
Fecha de Pago: Ago-2017
Monto Adelanto Directo salignado (Sin I.G.V.): S/. 5,395.76
Monto Adelanto Directo salignado (Sin I.G.V.): S/. 5,395.76
A/C = 12.40%

N°	Mes	Valorización Monto Total (1)	Amortización en el mes (2) = (1)*(A/C)	Deuda al Mes Anterior (3)	Saldo al Mes (3) - (2)	"K" del Mes		"K" al Pago (AGOSTO 2017)	Coeficiente	Deducción Adelanto Directo N° 01
						Mes	K			
01	Set-17	11,730.38	1,173.04	5,395.76	4,222.72			1.011	0.0000	0.00
02	Oct-17	6,602.88	660.29	4,222.72	3,562.43			1.012	0.0003	0.19
03	Nov-17	1,696.97	169.70	3,562.43	3,392.73			1.006	-0.0049	-0.83
04	Dic-17	3,106.81	310.68	3,392.73	3,082.05			1.006	-0.0053	-1.64
05	Ene-18	1,825.80	205.22	3,082.05	2,876.83			1.006	-0.0050	-1.02
06	Feb-18	1,114.13	125.23	2,876.83	2,751.60			1.006	-0.0050	-0.62
07	Mar-18	1,398.80	137.23	2,751.60	2,594.37			1.006	-0.0048	-0.76
08	Abr-18	1,114.13	125.23	2,594.37	2,469.14			1.011	0.0001	0.02
09	May-18	4,359.49	489.33	2,469.14	1,979.81			1.010	-0.0008	-0.41
10	Jun-18	2,276.85	255.92	1,979.81	1,723.89			1.011	0.0062	1.59
11	Jul-18	675.35	75.91	1,723.89	1,647.98			1.017	0.0060	0.45
12	Ago-18	447.25	50.27	1,647.98	1,597.71			1.018	0.0182	0.32
13	Set-18	1,572.41	184.69	1,597.71	1,413.11			1.030	0.0182	0.36
14	Oct-18	59.63	7.00	1,413.11	1,406.11			1.035	0.0237	0.17
15	Nov-18	29.82	3.57	1,406.11	1,402.54			1.032	0.0210	0.07
16	Dic-18	29.82	3.57	1,402.54	1,398.97			1.032	0.0210	0.07
17	Ene-19	0.00	0.00	1,398.97	1,398.97			1.032	0.0210	0.00
18	Feb-19	0.00	0.00	1,398.97	1,398.97			1.055	0.0428	0.00
Total		38,034.52	3,998.79							0.96

(*) : IU conocido hasta el momento

Acumulado Total	0.96
Acumulado Anterior	0.96
Deducción del mes	0.00

Amortización Actual (Febrero 2019)

0.00

Deducción Actual (Febrero 2019)

0.00

LUDWIG GARRASCO BUSTAMANTE
Supervisor - CIP 79040
CESEL S.A.

0000008



VALORIZACION N° 18 DEL 01 AL 28 DE FEBRERO DEL 2019 (PRECIOS UNITARIOS)



Contrato N° 025-2017-FONDEPES Ejecución de la Obra: MEJORAMIENTO DE LOS SERVICIOS DEL DESMARCADERO PESQUERO ARTESANAL DE SUPE, REGION LIMA, PROVINCIA DE BARRANCA, DISTRITO DE SUPE PUERTO



VALORIZACIÓN N° 18 DEL 01 AL 28 DE FEBRERO DEL 2019 (PRECIOS UNITARIOS)

OBRA: MEJORAMIENTO DE LOS SERVICIOS DEL DESMARCADERO PESQUERO ARTESANAL DE SUPE, REGION LIMA, PROVINCIA DE BARRANCA, DISTRITO DE SUPE PUERTO
 PROP: FONDEPES
 CONT: CONSORCIO MARITIMO DEL NORTE
 SUP: CESEL

CUADRO DE REINTEGROS

FORMULA POLINOMICA N° 01: OBRAS PORTUARIAS

MES	VAL N°	Valorización Programada	Valorización Programada Acumulada	PROGRAMADO		Resjesta V(K-1)	Resjesta Programado Acumulado	Valorización Ejecutada	Valorización Ejecutada Acumulada	EJECUTADO		Resjesta V(K-1)	Resjesta Ejecutado Acumulado
				"K" del Mes						"K" del Mes			
				Mes	K					Mes	K		
Sep-2017	01	S/. 837,418.43	S/. 837,418.43	Ago-2017	1.021	17,809.05	S/. 17,809.05	S/. 106,436.31	S/. 106,436.31	Ago-2017	1.021	S/. 2,233.16	S/. 2,233.16
Oct-2017	02	S/. 1,664,836.84	S/. 2,502,255.27	Sep-2017	1.023	42,121.12	S/. 60,110.18	S/. 84,137.40	S/. 190,573.71	Sep-2017	1.023	S/. 108.93	S/. 2,342.10
Nov-2017	03	S/. 807,678.00	S/. 3,309,933.27	Oct-2017	1.024	18,646.12	S/. 78,756.30	S/. 293,242.78	S/. 1,343,036.49	Oct-2017	1.024	S/. 413.51	S/. 2,755.61
Dic-2017	04	S/. 1,422,065.85	S/. 4,731,999.12	Nov-2017	1.021	20,659.24	S/. 99,415.54	S/. 1,187,259.48	S/. 2,530,295.97	Nov-2017	1.021	S/. 128.40	S/. 2,884.01
Ene-2018	05	S/. 349,008.19	S/. 5,081,007.31	Dic-2017	1.026	8,954.94	S/. 108,370.48	S/. 329,034.42	S/. 2,859,330.40	Dic-2017	1.026	S/. 102.94	S/. 2,986.95
Feb-2018	06	S/. 437,699.40	S/. 5,518,706.71	Ene-2018	1.027	11,726.59	S/. 120,097.07	S/. 151,262.00	S/. 3,010,632.40	Ene-2018	1.027	S/. 104.94	S/. 3,091.89
Mar-2018	07	S/. 143,181.55	S/. 5,661,888.26	Feb-2018	1.049	6,990.13	S/. 127,087.20	S/. 75,299.47	S/. 3,036,337.87	Feb-2018	1.049	S/. 674.68	S/. 3,766.57
Abr-2018	08	S/. 113,799.79	S/. 5,775,688.05	Mar-2018	1.054	6,090.44	S/. 133,177.64	S/. 29,539.99	S/. 3,065,877.86	Mar-2018	1.054	S/. 393.98	S/. 4,160.55
May-2018	09	S/. 1,253,319.42	S/. 7,029,007.47	Abr-2018	1.050	63,151.03	S/. 196,328.67	S/. 21,343.47	S/. 3,087,221.33	Abr-2018	1.050	S/. 073.43	S/. 4,234.00
Jun-2018	10	S/. 779,138.93	S/. 7,808,146.40	May-2018	1.061	15,869.41	S/. 212,198.08	S/. 87,013.77	S/. 3,074,274.20	May-2018	1.061	S/. 335.14	S/. 4,569.14
Jul-2018	11		S/. 7,808,146.40	Jun-2018	1.059	0.00	S/. 212,198.08	S/. 47,706.78	S/. 3,121,980.98	Jun-2018	1.059	S/. 2,807.14	S/. 7,376.28
Ago-2018	12		S/. 7,808,146.40	Jul-2018	1.063	0.00	S/. 212,198.08	S/. 20,567.19	S/. 3,142,548.18	Jul-2018	1.063	S/. 1,298.50	S/. 8,674.78
Sep-2018	13		S/. 7,808,146.40	Ago-2018	1.076	0.00	S/. 212,198.08	S/. 0.00	S/. 3,142,548.18	Ago-2018	1.076	S/. 0.00	S/. 8,674.78
Oct-2018	14		S/. 7,808,146.40	Sep-2018	1.081	0.00	S/. 212,198.08	S/. 0.00	S/. 3,142,548.18	Sep-2018	1.081	S/. 0.00	S/. 8,674.78
Nov-2018	15		S/. 7,808,146.40	Oct-2018	1.083	0.00	S/. 212,198.08	S/. 0.00	S/. 3,142,548.18	Oct-2018	1.083	S/. 0.00	S/. 8,674.78
Dic-2018	16		S/. 7,808,146.40	Nov-2018	1.094	0.00	S/. 212,198.08	S/. 0.00	S/. 3,142,548.18	Nov-2018	1.094	S/. 0.00	S/. 8,674.78
Ene-2019	17		S/. 7,808,146.40	Dic-2018	1.069	0.00	S/. 212,198.08	S/. 0.00	S/. 3,142,548.18	Dic-2018	1.069	S/. 0.00	S/. 8,674.78
Feb-2019	18		S/. 7,808,146.40	Ene-2019	1.065	0.00	S/. 212,198.08	S/. 0.00	S/. 3,142,548.18	Ene-2019	1.065	S/. 0.00	S/. 8,674.78
TOTAL		S/. 7,304,515.21				S/. 223,638.18	S/. 223,638.18	S/. 3,454,756.53	S/. 3,454,756.53			S/. 103,802.95	S/. 103,802.95

Sub total con deductivo 1

Sub Total Exp Técnico S/. 6,897,118.06
 Sub Total Deductivo 1 S/. -1,592,602.85
 S/. 7,304,515.21

Acumulado Total	103,802.95
Acumulado Anterior	88,549.96
Reintegro del mes	15,253.00

CUADRO DE REINTEGROS

FORMULA POLINOMICA N° 02: EDIFICIO EN TIERRA ESTRUCTURA

MES	VAL N°	Valorización Programada	Valorización Programada Acumulada	PROGRAMADO		Resjesta V(K-1)	Resjesta Programado Acumulado	Valorización Ejecutada	Valorización Ejecutada Acumulada	EJECUTADO		Resjesta V(K-1)	Resjesta Ejecutado Acumulado
				"K" del Mes						"K" del Mes			
				Mes	K					Mes	K		
Sep-2017	01	S/. 26,043.36	S/. 26,043.36	Ago-2017	1.015	382.035	S/. 382.03	S/. 119,395.59	S/. 119,395.59	Ago-2017	1.015	S/. 1,751.42	S/. 1,751.42
Oct-2017	02	S/. 729,575.30	S/. 755,618.66	Sep-2017	1.017	3,937.760	S/. 4,319.79	S/. 157,933.71	S/. 277,329.30	Sep-2017	1.017	S/. 2,662.55	S/. 4,413.97
Nov-2017	03	S/. 1,185,146.83	S/. 1,840,765.49	Oct-2017	1.017	20,449.491	S/. 24,769.28	S/. 637,570.31	S/. 1,134,899.61	Oct-2017	1.017	S/. 14,797.22	S/. 15,211.19
Dic-2017	04	S/. 374,672.53	S/. 1,779,838.02	Nov-2017	1.015	5,133.112	S/. 29,902.40	S/. 129,517.03	S/. 1,273,416.60	Nov-2017	1.015	S/. 2,123.27	S/. 17,334.46
Ene-2018	05	S/. 644,772.22	S/. 2,424,610.24	Dic-2017	1.017	11,227.803	S/. 41,129.90	S/. 39,320.73	S/. 1,326,737.38	Dic-2017	1.017	S/. 928.43	S/. 18,262.89
Feb-2018	06	S/. 403,780.73	S/. 2,828,390.97	Ene-2018	1.020	8,616.400	S/. 49,746.30	S/. 253,267.64	S/. 1,580,005.00	Ene-2018	1.020	S/. 3,040.69	S/. 21,303.58
Mar-2018	07	S/. 780,477.84	S/. 3,608,868.81	Feb-2018	1.041	28,729.294	S/. 78,475.59	S/. 346,894.19	S/. 1,926,899.19	Feb-2018	1.041	S/. 10,125.67	S/. 31,429.25
Abr-2018	08	S/. 4,492.02	S/. 3,613,360.83	Mar-2018	1.044	0.000	S/. 78,475.59	S/. 51,813.51	S/. 1,978,712.70	Mar-2018	1.044	S/. 2,264.18	S/. 33,693.43
May-2018	09		S/. 3,613,360.83	Abr-2018	1.020	0.000	S/. 78,475.59	S/. 121,486.47	S/. 2,099,899.16	May-2018	1.046	S/. 6,123.06	S/. 39,816.49
Jun-2018	10		S/. 3,613,360.83	May-2018	1.046	0.000	S/. 78,475.59	S/. 154,351.86	S/. 2,254,251.02	Jun-2018	1.044	S/. 6,768.26	S/. 46,584.75
Jul-2018	11		S/. 3,613,360.83	Jun-2018	1.044	0.000	S/. 78,475.59	S/. 198,058.29	S/. 2,452,309.31	Jul-2018	1.048	S/. 4,785.07	S/. 51,369.82
Ago-2018	12		S/. 3,613,360.83	Jul-2018	1.048	0.000	S/. 78,475.59	S/. 104,518.40	S/. 2,556,827.71	Ago-2018	1.050	S/. 622.90	S/. 51,992.72
Sep-2018	13		S/. 3,613,360.83	Ago-2018	1.059	0.000	S/. 78,475.59	S/. 10,478.98	S/. 2,567,306.69	Sep-2018	1.053	S/. 54.96	S/. 52,047.68
Oct-2018	14		S/. 3,613,360.83	Sep-2018	1.061	0.000	S/. 78,475.59	S/. 69,394.83	S/. 2,636,701.52	Oct-2018	1.061	S/. 4,246.72	S/. 56,294.40
Nov-2018	15		S/. 3,613,360.83	Oct-2018	1.063	0.000	S/. 78,475.59	S/. 13,937.28	S/. 2,650,638.80	Nov-2018	1.063	S/. 4,340	S/. 60,634.40
Dic-2018	16		S/. 3,613,360.83	Nov-2018	1.065	0.000	S/. 78,475.59	S/. 274,189.73	S/. 2,924,828.53	Dic-2018	1.065	S/. 8,109	S/. 68,743.50
Ene-2019	17		S/. 3,613,360.83	Dic-2018	1.069	0.000	S/. 78,475.59	S/. 32,737.83	S/. 2,957,566.36	Ene-2019	1.069	S/. 46,440	S/. 115,183.50
Feb-2019	18		S/. 3,613,360.83	Ene-2019	1.066	0.000	S/. 78,475.59	S/. 17,208.85	S/. 2,974,775.21	Feb-2019	1.066	S/. 1,130.46	S/. 116,313.96
TOTAL		S/. 5,532,361.09				S/. 78,080.64	S/. 78,080.64	S/. 2,851,631.39	S/. 2,851,631.39			S/. 70,241.26	S/. 70,241.26

Sub total con deductivo 4

Sub Total Exp Técnico S/. 3,691,408.51
 Sub Total Deductivo 4 S/. -159,047.42
 S/. 3,532,361.09

Acumulado Total	70,241.26
Acumulado Anterior	69,110.80
Reintegro del mes	1,130.46

[Firma]
LUDWIG CARRASCO BUSTAMANT
 Ing. Supervisor - CIP 78040
CESEL S.A.



VALORIZACIÓN N° 18 DEL 01 AL 28 DE FEBRERO DEL 2019 (PRECIOS UNITARIOS)



Contrato N° 025-2017- FONDERES Ejecución de la Obra: MEJORAMIENTO DE LOS SERVICIOS DEL DESEMBAUCADERO PESQUERO ARTESANAL DE SUPERREGION LIMA, PROVINCIA DE BARRANCA, DISTRITO DE SUPE PUERTO



VALORIZACIÓN N° 18 DEL 01 AL 28 DE FEBRERO DEL 2019 (PRECIOS UNITARIOS)

OBRA: MEJORAMIENTO DE LOS SERVICIOS DEL DESEMBAUCADERO PESQUERO ARTESANAL DE SUPE, REGION LIMA, PROVINCIA DE BARRANCA, DISTRITO DE SUPE PUERTO
 PROC: FONDERES
 CONIT: CONSORCIO HARTIDO DEL NORTE
 SUP: CESEL

CUADRO DE REINTEGROS

FORMULA POLINOMICA N° 03:

EDIFICIO EN TIERRA ARQUITECTURA

MES	VAL. N°	Valorización Programada	Valorización Programada Acumulada	PROGRAMADO			Reajuste V(K-1)	Reajuste Programado Acumulado	Valorización Ejecutada	Valorización Ejecutada Acumulada	EJECUTADO			
				"K" del Mes		Reajuste V(K-1)					Mes	K	Reajuste V(K-1)	Reajuste Ejecutado Acumulado
				Mes	K									
Set-2017	01	S/. 0,00	S/. 0,00	Set-2017	01	0,00	S/. 0,00	S/. 0,00	S/. 0,00	Set-2017	01	0,00	S/. 0,00	
Oct-2017	02	S/. 0,00	S/. 0,00	Oct-2017	02	0,00	S/. 0,00	S/. 0,00	S/. 0,00	Oct-2017	02	0,00	S/. 0,00	
Nov-2017	03	S/. 0,00	S/. 0,00	Nov-2017	03	0,00	S/. 0,00	S/. 0,00	S/. 0,00	Nov-2017	03	0,00	S/. 0,00	
Dic-2017	04	S/. 0,00	S/. 0,00	Dic-2017	04	0,00	S/. 0,00	S/. 0,00	S/. 0,00	Dic-2017	04	0,00	S/. 0,00	
Ene-2018	05	S/. 194,752.24	S/. 194,752.24	Ene-2018	05	4,521.841	S/. 4,521.841	S/. 0,00	S/. 0,00	Ene-2018	05	4,521.841	S/. 4,521.841	
Feb-2018	06	S/. 0,00	S/. 194,752.24	Feb-2018	06	0,00	S/. 4,521.841	S/. 31,040.63	S/. 31,040.63	Feb-2018	06	4,521.841	S/. 9,043.682	
Mar-2018	07	S/. 0,00	S/. 194,752.24	Mar-2018	07	0,00	S/. 4,521.841	S/. 14,568.07	S/. 45,608.72	Mar-2018	07	4,521.841	S/. 13,590.523	
Abr-2018	08	S/. 1,087,859.99	S/. 1,272,612.23	Abr-2018	08	78,382,999	S/. 82,904.83	S/. 26,672.40	S/. 82,200.12	Abr-2018	08	107,2	S/. 1,104,222.4	
May-2018	09	S/. 453,610.00	S/. 1,726,222.23	May-2018	09	21,136.751	S/. 104,241.58	S/. 18,730.19	S/. 101,010.31	May-2018	09	1,072	S/. 1,719,023.4	
Jun-2018	10	S/. 1,726,222.23	S/. 1,726,222.23	Jun-2018	10	0,00	S/. 104,241.58	S/. 11,126.57	S/. 112,136.88	Jun-2018	10	1,072	S/. 1,720,095.4	
Jul-2018	11	S/. 1,726,222.23	S/. 1,726,222.23	Jul-2018	11	0,00	S/. 104,241.58	S/. 49,037.86	S/. 201,234.74	Jul-2018	11	1,052	S/. 1,821,332.4	
Ago-2018	12	S/. 1,726,222.23	S/. 1,726,222.23	Ago-2018	12	0,00	S/. 104,241.58	S/. 27,261.74	S/. 208,496.48	Ago-2018	12	1,052	S/. 1,929,829.4	
Sep-2018	13	S/. 1,726,222.23	S/. 1,726,222.23	Sep-2018	13	0,00	S/. 104,241.58	S/. 24,748.19	S/. 323,244.68	Sep-2018	13	1,072	S/. 2,053,074.4	
Oct-2018	14	S/. 1,726,222.23	S/. 1,726,222.23	Oct-2018	14	0,00	S/. 104,241.58	S/. 70,065.06	S/. 393,339.74	Oct-2018	14	1,074	S/. 2,123,144.4	
Nov-2018	15	S/. 1,726,222.23	S/. 1,726,222.23	Nov-2018	15	0,00	S/. 104,241.58	S/. 78,688.78	S/. 470,028.52	Nov-2018	15	1,076	S/. 2,201,833.4	
Dic-2018	16	S/. 1,726,222.23	S/. 1,726,222.23	Dic-2018	16	0,00	S/. 104,241.58	S/. 6,914.26	S/. 476,942.78	Dic-2018	16	1,079	S/. 2,208,747.4	
Ene-2019	17	S/. 1,726,222.23	S/. 1,726,222.23	Ene-2019	17	0,00	S/. 104,241.58	S/. 49,119.77	S/. 526,062.55	Ene-2019	17	1,079	S/. 2,257,867.4	
Feb-2019	18	S/. 1,726,222.23	S/. 1,726,222.23	Feb-2019	18	0,00	S/. 104,241.58	S/. 77,189.94	S/. 603,252.49	Feb-2019	18	1,075	S/. 2,335,120.4	
TOTAL		S/. 1,738,222.23	S/. 1,738,222.23				S/. 104,241.58	S/. 643,146.53	S/. 643,146.53			S/. 42,549.29	S/. 42,549.29	

Sub total, no tiene deductivo

Acumulado Total	42,549.29
Acumulado Anterior	35,760.71
Reintegro del mes	5,788.58

CUADRO DE REINTEGROS

FORMULA POLINOMICA N° 04:

EDIFICIO EN TIERRA INSTALACIONES ELECTRICAS

MES	VAL. N°	Valorización Programada	Valorización Programada Acumulada	PROGRAMADO			Reajuste V(K-1)	Reajuste Programado Acumulado	Valorización Ejecutada	Valorización Ejecutada Acumulada	EJECUTADO			
				"K" del Mes		Reajuste V(K-1)					Mes	K	Reajuste V(K-1)	Reajuste Ejecutado Acumulado
				Mes	K									
Set-2017	01	S/. 0,00	S/. 0,00	Set-2017	01	0,00	S/. 0,00	S/. 0,00	S/. 0,00	Set-2017	01	0,00	S/. 0,00	
Oct-2017	02	S/. 0,00	S/. 0,00	Oct-2017	02	0,00	S/. 0,00	S/. 0,00	S/. 0,00	Oct-2017	02	0,00	S/. 0,00	
Nov-2017	03	S/. 0,00	S/. 0,00	Nov-2017	03	0,00	S/. 0,00	S/. 0,00	S/. 0,00	Nov-2017	03	0,00	S/. 0,00	
Dic-2017	04	S/. 0,00	S/. 0,00	Dic-2017	04	0,00	S/. 0,00	S/. 0,00	S/. 0,00	Dic-2017	04	0,00	S/. 0,00	
Ene-2018	05	S/. 11,167.72	S/. 11,167.72	Ene-2018	05	-688.128	S/. -688.128	S/. 0,00	S/. 0,00	Ene-2018	05	0,00	S/. 0,00	
Feb-2018	06	S/. 42,546.47	S/. 53,714.19	Feb-2018	06	-2,622.329	S/. -3,310.44	S/. 0,00	S/. 0,00	Feb-2018	06	0,00	S/. 0,00	
Mar-2018	07	S/. 87,872.81	S/. 141,587.00	Mar-2018	07	-3,054.032	S/. -7,364.47	S/. 7,708.42	S/. 7,708.42	Mar-2018	07	0,00	S/. 0,00	
Abr-2018	08	S/. 37,814.88	S/. 179,391.98	Abr-2018	08	-2,088.724	S/. -9,453.19	S/. 11,492.22	S/. 19,198.69	Abr-2018	08	0,00	S/. 0,00	
May-2018	09	S/. 159,301.98	S/. 338,693.96	May-2018	09	0,00	S/. -9,453.19	S/. 10,808.43	S/. 30,007.13	May-2018	09	0,00	S/. 0,00	
Jun-2018	10	S/. 159,301.98	S/. 497,995.94	Jun-2018	10	0,00	S/. -9,453.19	S/. 0,00	S/. 30,487.53	Jun-2018	10	0,00	S/. -1,662.67	
Jul-2018	11	S/. 159,301.98	S/. 657,297.92	Jul-2018	11	0,00	S/. -9,453.19	S/. 5,940.78	S/. 36,428.31	Jul-2018	11	0,00	S/. -1,943.98	
Ago-2018	12	S/. 159,301.98	S/. 816,600	Ago-2018	12	0,00	S/. -9,453.19	S/. -300.40	S/. 31,997.70	Ago-2018	12	0,00	S/. -1,930.81	
Sep-2018	13	S/. 159,301.98	S/. 975,901.98	Sep-2018	13	0,00	S/. -9,453.19	S/. 227.96	S/. 31,725.68	Sep-2018	13	0,00	S/. -1,744.69	
Oct-2018	14	S/. 159,301.98	S/. 1,135,203.96	Oct-2018	14	0,00	S/. -9,453.19	S/. -3,075.46	S/. 32,650.19	Oct-2018	14	0,00	S/. -1,620.60	
Nov-2018	15	S/. 159,301.98	S/. 1,294,505.94	Nov-2018	15	0,00	S/. -9,453.19	S/. 0,00	S/. 32,650.19	Nov-2018	15	0,00	S/. -1,620.60	
Dic-2018	16	S/. 159,301.98	S/. 1,453,807.92	Dic-2018	16	0,00	S/. -9,453.19	S/. 0,00	S/. 32,650.19	Dic-2018	16	0,00	S/. -1,620.60	
Ene-2019	17	S/. 159,301.98	S/. 1,613,109.90	Ene-2019	17	0,00	S/. -9,453.19	S/. 2,764.29	S/. 35,414.48	Ene-2019	17	0,00	S/. -1,708.04	
Feb-2019	18	S/. 159,301.98	S/. 1,772,411.88	Feb-2019	18	0,00	S/. -9,453.19	S/. 0,00	S/. 35,414.48	Feb-2019	18	0,00	S/. -1,708.04	
TOTAL		S/. 159,301.98	S/. 159,301.98				S/. -9,251.19	S/. 35,414.48	S/. 35,414.48			S/. -1,708.04	S/. -1,708.04	

Sub total con deductivo 2 y 5

Sub Total Exp Técnico S/. 653,003.57
 Sub Total Deductivo 2 S/. -203,822.30
 Sub Total Deductivo 5 S/. -287,879.29
 S/. 159,301.98

Acumulado Total	-1,708.04
Acumulado Anterior	-1,708.04
Reintegro del mes	0.00

.....
 LUDWIG GARRASCO BUSTAMANTE
 Ing. Supervisor - CIP 79040
 CESEL S.A.

000002



VALORIZACIÓN N° 18 DEL 01 AL 28 DE FEBRERO DEL 2019 (PRECIOS UNITARIOS)



Contrato N° 023-2017- FORDEPES Ejecución de la Obra: MEJORAMIENTO DE LOS SERVICIOS DEL DESEMBARCADERO PESQUERO ARTESANAL DE SUPE, REGION LIMA, PROVINCIA DE BARRANCA, DISTRITO DE SUPE PUERTO



VALORIZACIÓN N° 18 DEL 01 AL 28 DE FEBRERO DEL 2019 (PRECIOS UNITARIOS)

OBRA: MEJORAMIENTO DE LOS SERVICIOS DEL DESEMBARCADERO PESQUERO ARTESANAL DE SUPE, REGION LIMA, PROVINCIA DE BARRANCA, DISTRITO DE SUPE PUERTO
 PRDP: FONDEPES
 CONT: CONSORCIO MARITIMO DEL NORTE
 SUP: CESEL

CUADRO DE REINTEGROS

FORMULA POLINÓMICA N° 05: EDIFICIO EN TIERRA INSTALACIONES SANITARIAS

MES	VAL N°	PROGRAMADO						EJECUTADO					
		Valorización Programada	Valorización Programada Acumulada	"K" del Mes		Reajuste V(K-1)	Reajuste Programado Acumulado	Valorización Ejecutada	Valorización Ejecutada Acumulada	"K" del Mes		Reajuste V(K-1)	Reajuste Ejecutado Acumulado
				Mar	K					Mar	K		
Set-2017	01	S/. 22,807.13	S/. 22,807.13	Set-2017	1.139	3,166.939	S/. 3,166.96	S/. 0.00	S/. 0.00	Set-2017	1.139	0.000	S/. 0.00
Oct-2017	02	S/. 22,807.13	S/. 45,614.26	Set-2017	1.140	0.000	S/. 3,166.96	S/. 0.00	S/. 0.00	Set-2017	1.140	0.000	S/. 0.00
Nov-2017	03	S/. 147,440.49	S/. 170,242.42	Oct-2017	1.141	21,174.227	S/. 24,341.19	S/. 0.00	S/. 0.00	Oct-2017	1.141	0.000	S/. 0.00
Dic-2017	04	S/. 403,260.33	S/. 573,502.94	Nov-2017	1.143	57,582.636	S/. 81,924.02	S/. 0.00	S/. 0.00	Nov-2017	1.143	0.000	S/. 0.00
Ene-2018	05	S/. 29,944.93	S/. 603,447.89	Dic-2017	1.143	4,287.822	S/. 86,211.89	S/. 0.00	S/. 0.00	Dic-2017	1.143	0.000	S/. 0.00
Feb-2018	06	S/. 603,452.89	S/. 1,206,900.78	Ene-2018	1.143	0.000	S/. 86,211.89	S/. 0.00	S/. 0.00	Ene-2018	1.143	0.000	S/. 0.00
Mar-2018	07	S/. 603,452.89	S/. 1,810,353.67	Feb-2018	1.150	0.000	S/. 86,211.89	S/. 4,508.32	S/. 4,508.32	Feb-2018	1.150	677.495	S/. 677.90
Abr-2018	08	S/. 603,452.89	S/. 2,413,806.56	Mar-2018	1.154	0.000	S/. 86,211.89	S/. 0.00	S/. 4,508.32	Mar-2018	1.154	0.000	S/. 677.90
May-2018	09	S/. 30,964.10	S/. 2,444,770.66	Abr-2018	1.154	4,778.969	S/. 90,990.88	S/. 0.00	S/. 12,087.22	Abr-2018	1.154	1,290.323	S/. 1,967.82
Jun-2018	10	S/. 634,416.98	S/. 2,979,187.64	May-2018	1.160	0.000	S/. 90,990.88	S/. 0.00	S/. 12,087.22	May-2018	1.160	0.000	S/. 1,967.82
Jul-2018	11	S/. 634,416.98	S/. 3,413,604.62	Jun-2018	1.162	0.000	S/. 90,990.88	S/. 3,076.39	S/. 16,243.70	Jun-2018	1.162	626.924	S/. 2,594.74
Ago-2018	12	S/. 634,416.98	S/. 3,948,021.60	Jul-2018	1.162	0.000	S/. 90,990.88	S/. 900.49	S/. 17,632.19	Jul-2018	1.162	147.597	S/. 2,742.14
Sep-2018	13	S/. 634,416.98	S/. 4,482,438.58	Ago-2018	1.179	0.000	S/. 90,990.88	S/. 0.00	S/. 17,632.19	Ago-2018	1.179	-734.155	S/. 2,007.99
Oct-2018	14	S/. 634,416.98	S/. 5,016,855.56	Sep-2018	1.182	0.000	S/. 90,990.88	S/. 4,289.91	S/. 21,942.10	Sep-2018	1.182	761.891	S/. 2,769.88
Nov-2018	15	S/. 634,416.98	S/. 5,651,272.54	Oct-2018	1.183	0.000	S/. 90,990.88	S/. 0.00	S/. 21,942.10	Oct-2018	1.183	0.000	S/. 2,769.88
Dic-2018	16	S/. 634,416.98	S/. 6,285,689.52	Nov-2018	1.185	0.000	S/. 90,990.88	S/. 84,289.63	S/. 106,332.75	Nov-2018	1.185	15,619.437	S/. 18,409.33
Ene-2019	17	S/. 634,416.98	S/. 6,920,106.50	Dic-2018	1.182	0.000	S/. 90,990.88	S/. 1,005.71	S/. 107,418.46	Dic-2018	1.182	197.326	S/. 18,606.66
Feb-2019	18	S/. 634,416.98	S/. 7,554,523.48	Ene-2019	1.178	0.000	S/. 90,990.88	S/. -8,217.99	S/. 99,200.47	Ene-2019	1.178	-1,463.532	S/. 17,143.11
TOTAL		S/. 634,416.98	S/. 7,554,523.48			S/. 90,990.88	S/. 90,990.88	S/. 99,200.47			S/. 17,143.11	S/. 17,143.11	

Sub total con deductivo 3

Sub Total Exp Técnico S/. 620,930.60
 Sub Total Deductivo 3 S/. -186,618.62
 S/. 434,311.98

Acumulado Total	17,143.11
Acumulado Anterior	18,606.66
Reintegro del mes	-1,463.55

CUADRO DE REINTEGROS

FORMULA POLINÓMICA N° 06: EDIFICIO EN TIERRA EQUIPAMIENTO

MES	VAL N°	PROGRAMADO						EJECUTADO					
		Valorización Programada	Valorización Programada Acumulada	"K" del Mes		Reajuste V(K-1)	Reajuste Programado Acumulado	Valorización Ejecutada	Valorización Ejecutada Acumulada	"K" del Mes		Reajuste V(K-1)	Reajuste Ejecutado Acumulado
				Mar	K					Mar	K		
Set-2017	01	S/. 0.00	S/. 0.00	Set-2017	0.995	0.000	S/. 0.00	S/. 0.00	S/. 0.00	Set-2017	0.995	0.000	S/. 0.00
Oct-2017	02	S/. 0.00	S/. 0.00	Set-2017	0.997	0.000	S/. 0.00	S/. 0.00	S/. 0.00	Set-2017	0.997	0.000	S/. 0.00
Nov-2017	03	S/. 0.00	S/. 0.00	Oct-2017	0.999	0.000	S/. 0.00	S/. 0.00	S/. 0.00	Oct-2017	0.999	0.000	S/. 0.00
Dic-2017	04	S/. 0.00	S/. 0.00	Nov-2017	0.995	0.000	S/. 0.00	S/. 0.00	S/. 0.00	Nov-2017	0.995	0.000	S/. 0.00
Ene-2018	05	S/. 0.00	S/. 0.00	Dic-2017	0.999	0.000	S/. 0.00	S/. 0.00	S/. 0.00	Dic-2017	0.999	0.000	S/. 0.00
Feb-2018	06	S/. 0.00	S/. 0.00	Ene-2018	0.990	0.000	S/. 0.00	S/. 0.00	S/. 0.00	Ene-2018	0.990	0.000	S/. 0.00
Mar-2018	07	S/. 0.00	S/. 0.00	Feb-2018	1.003	0.000	S/. 0.00	S/. 0.00	S/. 0.00	Feb-2018	1.003	0.000	S/. 0.00
Abr-2018	08	S/. 31,539.06	S/. 31,539.06	Mar-2018	1.008	294.798	S/. 294.80	S/. 0.00	S/. 0.00	Mar-2018	1.008	0.000	S/. 0.00
May-2018	09	S/. 1,839,480.87	S/. 1,871,019.93	Abr-2018	1.002	3,419.298	S/. 3,704.09	S/. 0.00	S/. 0.00	Abr-2018	1.002	0.000	S/. 0.00
Jun-2018	10	S/. 482,384.03	S/. 2,353,403.96	May-2018	1.010	8,468.562	S/. 12,173.65	S/. 0.00	S/. 0.00	May-2018	1.010	0.000	S/. 0.00
Jul-2018	11	S/. 2,373,404.06	S/. 4,726,808.02	Jun-2018	1.018	0.000	S/. 12,173.65	S/. 0.00	S/. 0.00	Jun-2018	1.018	0.000	S/. 0.00
Ago-2018	12	S/. 2,373,404.06	S/. 7,100,212.08	Jul-2018	1.021	0.000	S/. 12,173.65	S/. 1,378,948.60	S/. 1,378,948.60	Jul-2018	1.021	29,404.775	S/. 29,404.78
Sep-2018	13	S/. 2,373,404.06	S/. 9,473,616.14	Ago-2018	1.029	0.000	S/. 12,173.65	S/. 0.00	S/. 0.00	Ago-2018	1.029	0.000	S/. 29,404.78
Oct-2018	14	S/. 2,373,404.06	S/. 11,847,020.20	Sep-2018	1.038	0.000	S/. 12,173.65	S/. 0.00	S/. 0.00	Sep-2018	1.038	0.000	S/. 29,404.78
Nov-2018	15	S/. 2,373,404.06	S/. 14,220,424.26	Oct-2018	1.046	0.000	S/. 12,173.65	S/. 0.00	S/. 0.00	Oct-2018	1.046	0.000	S/. 29,404.78
Dic-2018	16	S/. 2,373,404.06	S/. 16,593,828.32	Nov-2018	1.060	0.000	S/. 12,173.65	S/. 0.00	S/. 0.00	Nov-2018	1.060	0.000	S/. 29,404.78
Ene-2019	17	S/. 2,373,404.06	S/. 18,967,232.38	Dic-2018	1.059	0.000	S/. 12,173.65	S/. 0.00	S/. 0.00	Dic-2018	1.059	0.000	S/. 29,404.78
Feb-2019	18	S/. 2,373,404.06	S/. 21,340,636.44	Ene-2019	1.055	0.000	S/. 12,173.65	S/. 0.00	S/. 0.00	Ene-2019	1.055	0.000	S/. 29,404.78
TOTAL		S/. 2,373,404.06	S/. 21,340,636.44			S/. 12,173.65	S/. 12,173.65	S/. 1,378,948.60			S/. 29,404.78	S/. 29,404.78	

Acumulado Total	12,173.65
Acumulado Anterior	12,173.65
Reintegro del mes	0.00

LUDWING CARRASCO BUSTAMANTE
 Ing. Supervisor - CIP 79040
 CESEL S.A.

000023



VALORIZACIÓN N° 18 DEL 01 AL 28 DE FEBRERO DEL 2019 (PRECIOS UNITARIOS)



Contrato N° 025-2017- FONDERES Ejecución de la Obra: MEJORAMIENTO DE LOS SERVICIOS DEL DESEMBARCADERO PESQUERO ARTESANAL DE SUPE, REGION LIMA, PROVINCIA DE BARRANCA, DISTRITO DE SUPE PUERTO



VALORIZACIÓN N° 18 DEL 01 AL 28 DE FEBRERO DEL 2019 (PRECIOS UNITARIOS)

OBRA: MEJORAMIENTO DE LOS SERVICIOS DEL DESEMBARCADERO PESQUERO ARTESANAL DE SUPE, REGION LIMA, PROVINCIA DE BARRANCA, DISTRITO DE SUPE PUERTO
 PROP: FONDERES
 CONT: CONSORCIO MARITIMO DEL NORTE
 SUP: CESEL

CUADRO DE REINTEGROS

FORMULA POLINOMICA N° 07:

IMPACTO AMBIENTAL

MES	VAL. N°	Valorización Programada	Valorización Programada Acumulada	PROGRAMADO				Resjesta V(K-1)	Resjesta Programado Acumulado	Valorización Ejecutada	Valorización Ejecutada Acumulada	EJECUTADO			
				"K" del Mes		Resjesta V(K-1)	Resjesta Programado Acumulado					"K" del Mes		Resjesta V(K-1)	Resjesta Ejecutado Acumulado
				Mes	K							Mes	K		
Sep-2017	01	S/. 12,168.70	S/. 12,168.70	Sep-2017	1.011	136.936	S/. 136.60	S/. 11,730.38	S/. 11,730.38	Sep-2017	1.011	131.676	S/. 131.68		
Oct-2017	02	S/. 19,043.31	S/. 22,212.21	Sep-2017	1.012	115.650	S/. 252.25	S/. 6,602.89	S/. 18,333.28	Sep-2017	1.012	76.031	S/. 207.71		
Nov-2017	03	S/. 3,728.72	S/. 25,938.93	Oct-2017	1.006	23,492	S/. 275.73	S/. 1,898.97	S/. 20,030.23	Oct-2017	1.006	10.693	S/. 218.40		
Dic-2017	04	S/. 3,850.95	S/. 29,789.88	Nov-2017	1.006	23,661	S/. 299.39	S/. 3,109.81	S/. 23,137.04	Nov-2017	1.006	10.282	S/. 228.68		
Ene-2018	05	S/. 3,850.95	S/. 33,640.83	Dic-2017	1.006	24,265	S/. 323.85	S/. 1,425.90	S/. 24,562.94	Dic-2017	1.006	13.206	S/. 247.99		
Feb-2018	06	S/. 3,478.27	S/. 37,119.10	Ene-2018	1.007	23,661	S/. 346.31	S/. 1,114.13	S/. 25,677.07	Ene-2018	1.007	7.579	S/. 255.57		
Mar-2018	07	S/. 3,850.99	S/. 40,970.09	Feb-2018	1.006	24,453	S/. 370.77	S/. 2,478.77	S/. 28,155.84	Feb-2018	1.006	9.802	S/. 264.49		
Abr-2018	08	S/. 3,728.72	S/. 44,698.77	Mar-2018	1.011	42,283	S/. 413.03	S/. 1,114.13	S/. 29,270.00	Mar-2018	1.011	12.643	S/. 277.09		
May-2018	09	S/. 5,520.94	S/. 50,197.71	Abr-2018	1.010	57,039	S/. 470.09	S/. 4,353.40	S/. 33,623.40	Abr-2018	1.010	45.141	S/. 322.23		
Jun-2018	10	S/. 3,759.91	S/. 53,957.61	May-2018	1.018	65,003	S/. 535.90	S/. 2,226.85	S/. 35,850.25	May-2018	1.018	39.849	S/. 365.09		
Jul-2018	11	S/. 53,957.61	S/. 53,957.61	Jun-2018	1.017	0.000	S/. 535.90	S/. 675.35	S/. 36,525.60	Jun-2018	1.017	11.661	S/. 373.74		
Ago-2018	12	S/. 53,957.61	S/. 53,957.61	Jul-2018	1.018	0.000	S/. 535.90	S/. 447.25	S/. 37,000.00	Jul-2018	1.018	7.923	S/. 381.67		
Sep-2018	13	S/. 53,957.61	S/. 53,957.61	Ago-2018	1.030	0.000	S/. 535.90	S/. 1,572.41	S/. 38,572.41	Ago-2018	1.030	46.574	S/. 428.25		
Oct-2018	14	S/. 53,957.61	S/. 53,957.61	Sep-2018	1.035	0.000	S/. 535.90	S/. 39.63	S/. 39,000.00	Sep-2018	1.035	2.099	S/. 430.35		
Nov-2018	15	S/. 53,957.61	S/. 53,957.61	Oct-2018	1.032	0.000	S/. 535.90	S/. 29.62	S/. 39,535.90	Oct-2018	1.032	0.967	S/. 431.31		
Dic-2018	16	S/. 53,957.61	S/. 53,957.61	Nov-2018	1.032	0.000	S/. 535.90	S/. 29.62	S/. 40,071.52	Nov-2018	1.032	0.967	S/. 432.28		
Ene-2019	17	S/. 53,957.61	S/. 53,957.61	Dic-2018	1.032	0.000	S/. 535.90	S/. 0.00	S/. 40,607.42	Dic-2018	1.032	0.000	S/. 432.28		
Feb-2019	18	S/. 53,957.61	S/. 53,957.61	Ene-2019	1.030	0.000	S/. 535.90	S/. 0.00	S/. 41,143.32	Ene-2019	1.030	0.000	S/. 432.28		
TOTAL		S/. 63,937.61					S/. 535.90	S/. 38,034.52				S/. 432.28			

Acumulado Total	432.28
Acumulado Anterior	432.28
Reintegro del mes	0.00

LUDWING CARRASCO BUSTAMANTE
 Ing. Supervisor - CIP 79040
 CESEL S.A.

0000022



VALORIZACIÓN N° 18 DEL 01 AL 28 DE FEBRERO DEL 2019
(PRECIOS UNITARIOS)



AMORTIZACIÓN Y DEDUCCION QUE NO CORRESPONDE POR EL ADELANTO DE MATERIALES

OBRA: MIOBAMBIENTO DE LOS SERVICIOS DEL DESARROLLO PESQUERO ARTESANAL DE SUPE, REGION LIMA, PROVINCIA DE BARRANCA, DISTRITO DE SUPE PUERTO
PROP: FONDEPES
CONTRAT: CONSORCIO MARITIMO DEL NORTE
SUPERV: CESEL

ITEM	DESCRIPCION	Una	Una	N° VALOR HIZADO ON	MIS	Imp	VALORIZACION EJECUTADA	ADELANTO OTORGADO	ADELANTO DEDUCTIVO A LA FECHA BASE	EFECTOS DE LA FORMULA PARACONSUMO A	MONTO UTILIZABLE EN LA VALORIZACION	MONTO UTILIZADO ACUMULADO	DEDUCCION
0202000008	ACERO DE CONSTRUCCION CORRUGADO	42.17	42.17	01	SET	42.17	-	-	-	0.25	10.5427	10.5427	74.43
				02	OCT	42.17	167.5071			0.25	160.2572	160.2572	74.43
				03	NOV	42.17	65.3105			0.25	179.8273	179.8273	1.00
				04	DEC	42.17	83.2173			0.25	198.3747	198.3747	61.72
				05	JAN	472.49	53.2073			1.251	55.5207	41.3561	5.2071
				06	FEB	472.49	252.2074			0.25	319.8005	421.2076	2.2572
				07	MAR	502.31	346.0449			0.25	690.075	421.2076	0.0000
				08	ABR	506.47	518.8121			0.229	690.075	421.2076	0.0000
				09	MAY	501.96	131.2964			0.229	658.314	421.2076	1.2017
				10	JUN	513.58	344.39126			0.229	17.2075	421.2076	1.2018
				11	JUL	506.61	159.6529			0.229	25.6737	568.8315	2.41129
				12	AUG	512.37	104.63740			0.229	64.8103	633.6418	4.11129
				13	SEP	575.48	102.07126			0.229	136.174	633.8171	86.21
				14	OCT	527.80	69.34483			0.229	8.26677	642.0838	127.20
				15	NOV	533.71	13.92726			0.229	1.27291	643.3567	220.03
				16	DEC	541.71	221.18275			0.229	34.9248	678.2815	423.619
				17	JAN	542.08	327.2145			0.229	429.19	680.0233	72.259
				18	FEB	517.48	112.20626			0.229	22.2153	692.2386	31.12
SUB TOTAL							2.574.302.08						24.675.20

0202000008	AGREGADO GRUESO	279.54	279.54	01	SET	279.54				0.25	70.8306	70.8306	5.21
				02	OCT <td>279.54 <td>121.1047 <td></td> <td></td> <td>0.25 <td>70.8306 <td>70.8306 <td>5.21 </td></td></td></td></td></td>	279.54 <td>121.1047 <td></td> <td></td> <td>0.25 <td>70.8306 <td>70.8306 <td>5.21 </td></td></td></td></td>	121.1047 <td></td> <td></td> <td>0.25 <td>70.8306 <td>70.8306 <td>5.21 </td></td></td></td>			0.25 <td>70.8306 <td>70.8306 <td>5.21 </td></td></td>	70.8306 <td>70.8306 <td>5.21 </td></td>	70.8306 <td>5.21 </td>	5.21
				03	NOV <td>279.54 <td>124.13126 <td></td> <td></td> <td>0.25 <td>26.1467 <td>94.4233 <td>8.82 </td></td></td></td></td></td>	279.54 <td>124.13126 <td></td> <td></td> <td>0.25 <td>26.1467 <td>94.4233 <td>8.82 </td></td></td></td></td>	124.13126 <td></td> <td></td> <td>0.25 <td>26.1467 <td>94.4233 <td>8.82 </td></td></td></td>			0.25 <td>26.1467 <td>94.4233 <td>8.82 </td></td></td>	26.1467 <td>94.4233 <td>8.82 </td></td>	94.4233 <td>8.82 </td>	8.82
				04	DEC <td>279.54 <td>159.6529 <td></td> <td></td> <td>0.25 <td>49.6772 <td>94.1005 <td>8.82 </td></td></td></td></td></td>	279.54 <td>159.6529 <td></td> <td></td> <td>0.25 <td>49.6772 <td>94.1005 <td>8.82 </td></td></td></td></td>	159.6529 <td></td> <td></td> <td>0.25 <td>49.6772 <td>94.1005 <td>8.82 </td></td></td></td>			0.25 <td>49.6772 <td>94.1005 <td>8.82 </td></td></td>	49.6772 <td>94.1005 <td>8.82 </td></td>	94.1005 <td>8.82 </td>	8.82
				05	JAN <td>279.54 <td>104.58740 <td></td> <td></td> <td>0.25 <td>21.0713 <td>119.2015 <td>3.42 </td></td></td></td></td></td>	279.54 <td>104.58740 <td></td> <td></td> <td>0.25 <td>21.0713 <td>119.2015 <td>3.42 </td></td></td></td></td>	104.58740 <td></td> <td></td> <td>0.25 <td>21.0713 <td>119.2015 <td>3.42 </td></td></td></td>			0.25 <td>21.0713 <td>119.2015 <td>3.42 </td></td></td>	21.0713 <td>119.2015 <td>3.42 </td></td>	119.2015 <td>3.42 </td>	3.42
				06	FEB <td>279.54 <td>16.25826 <td></td> <td></td> <td>0.25 <td>22.2143 <td>141.0222 <td>6.298 </td></td></td></td></td></td>	279.54 <td>16.25826 <td></td> <td></td> <td>0.25 <td>22.2143 <td>141.0222 <td>6.298 </td></td></td></td></td>	16.25826 <td></td> <td></td> <td>0.25 <td>22.2143 <td>141.0222 <td>6.298 </td></td></td></td>			0.25 <td>22.2143 <td>141.0222 <td>6.298 </td></td></td>	22.2143 <td>141.0222 <td>6.298 </td></td>	141.0222 <td>6.298 </td>	6.298
				07	MAR <td>279.54 <td>69.34483 <td></td> <td></td> <td>0.229 <td>14.0022 <td>155.2970 <td>48.00 </td></td></td></td></td></td>	279.54 <td>69.34483 <td></td> <td></td> <td>0.229 <td>14.0022 <td>155.2970 <td>48.00 </td></td></td></td></td>	69.34483 <td></td> <td></td> <td>0.229 <td>14.0022 <td>155.2970 <td>48.00 </td></td></td></td>			0.229 <td>14.0022 <td>155.2970 <td>48.00 </td></td></td>	14.0022 <td>155.2970 <td>48.00 </td></td>	155.2970 <td>48.00 </td>	48.00
				08	ABR <td>279.54 <td>13.92726 <td></td> <td></td> <td>0.229 <td>2.9410 <td>168.3071 <td>1.298 </td></td></td></td></td></td>	279.54 <td>13.92726 <td></td> <td></td> <td>0.229 <td>2.9410 <td>168.3071 <td>1.298 </td></td></td></td></td>	13.92726 <td></td> <td></td> <td>0.229 <td>2.9410 <td>168.3071 <td>1.298 </td></td></td></td>			0.229 <td>2.9410 <td>168.3071 <td>1.298 </td></td></td>	2.9410 <td>168.3071 <td>1.298 </td></td>	168.3071 <td>1.298 </td>	1.298
				09	MAY <td>279.54 <td>71.12923 <td></td> <td></td> <td>0.229 <td>67.4622 <td>168.3071 <td>27.63 </td></td></td></td></td></td>	279.54 <td>71.12923 <td></td> <td></td> <td>0.229 <td>67.4622 <td>168.3071 <td>27.63 </td></td></td></td></td>	71.12923 <td></td> <td></td> <td>0.229 <td>67.4622 <td>168.3071 <td>27.63 </td></td></td></td>			0.229 <td>67.4622 <td>168.3071 <td>27.63 </td></td></td>	67.4622 <td>168.3071 <td>27.63 </td></td>	168.3071 <td>27.63 </td>	27.63
				10	JUN <td>279.54 <td>34.2345 <td></td> <td></td> <td>0.229 <td>65.4034 <td>202.0134 <td>47.63 </td></td></td></td></td></td>	279.54 <td>34.2345 <td></td> <td></td> <td>0.229 <td>65.4034 <td>202.0134 <td>47.63 </td></td></td></td></td>	34.2345 <td></td> <td></td> <td>0.229 <td>65.4034 <td>202.0134 <td>47.63 </td></td></td></td>			0.229 <td>65.4034 <td>202.0134 <td>47.63 </td></td></td>	65.4034 <td>202.0134 <td>47.63 </td></td>	202.0134 <td>47.63 </td>	47.63
				11	JUL <td>215.27</td> <td>11.22626 <td></td> <td></td> <td>0.229 <td>3.6416 <td>202.0134 <td>47.63 </td></td></td></td></td>	215.27	11.22626 <td></td> <td></td> <td>0.229 <td>3.6416 <td>202.0134 <td>47.63 </td></td></td></td>			0.229 <td>3.6416 <td>202.0134 <td>47.63 </td></td></td>	3.6416 <td>202.0134 <td>47.63 </td></td>	202.0134 <td>47.63 </td>	47.63
SUB TOTAL							972.520.15						-360.59
SUB TOTAL							6.121.534.31						37.168.51

Acumulado Total	37,695.51
Acumulado Anterior	37,167.88
Deducción del mes	527.63

DEDUCCION DEL MES DE FEBRERO 2019 FORMULA POLINOMICA N°02 527.63

FORMULA POLINOMICA N° 03:													
MATERIALES													
0202000007	CEMENTO PORTLAND TIPO V	418.10	418.10	31	SET	418.10				0.146	61.2621	61.2621	64.48
				32	OCT	418.10 <td>67.26114 <td></td> <td></td> <td>0.146 <td>61.2621 <td>61.2621 <td>64.48 </td></td></td></td></td>	67.26114 <td></td> <td></td> <td>0.146 <td>61.2621 <td>61.2621 <td>64.48 </td></td></td></td>			0.146 <td>61.2621 <td>61.2621 <td>64.48 </td></td></td>	61.2621 <td>61.2621 <td>64.48 </td></td>	61.2621 <td>64.48 </td>	64.48
				33	NOV	418.10 <td>34.74813 <td></td> <td></td> <td>0.146 <td>67.0724 <td>171.8146 <td>29.03</td> </td></td></td></td>	34.74813 <td></td> <td></td> <td>0.146 <td>67.0724 <td>171.8146 <td>29.03</td> </td></td></td>			0.146 <td>67.0724 <td>171.8146 <td>29.03</td> </td></td>	67.0724 <td>171.8146 <td>29.03</td> </td>	171.8146 <td>29.03</td>	29.03
				34	DEC	418.10 <td>79.29816 <td></td> <td></td> <td>0.146 <td>102.6723 <td>261.6723 <td>57.69</td> </td></td></td></td>	79.29816 <td></td> <td></td> <td>0.146 <td>102.6723 <td>261.6723 <td>57.69</td> </td></td></td>			0.146 <td>102.6723 <td>261.6723 <td>57.69</td> </td></td>	102.6723 <td>261.6723 <td>57.69</td> </td>	261.6723 <td>57.69</td>	57.69
				35	JAN <td>429.25 <td>76.66879 <td></td> <td></td> <td>0.146 <td>11.62934 <td>92.487</td> <td>59.247</td> </td></td></td></td>	429.25 <td>76.66879 <td></td> <td></td> <td>0.146 <td>11.62934 <td>92.487</td> <td>59.247</td> </td></td></td>	76.66879 <td></td> <td></td> <td>0.146 <td>11.62934 <td>92.487</td> <td>59.247</td> </td></td>			0.146 <td>11.62934 <td>92.487</td> <td>59.247</td> </td>	11.62934 <td>92.487</td> <td>59.247</td>	92.487	59.247
				36	FEB <td>429.25 <td>5.91126 <td></td> <td></td> <td>0.146 <td>1.0294</td> <td>11.62934 <td>51.07</td> </td></td></td></td>	429.25 <td>5.91126 <td></td> <td></td> <td>0.146 <td>1.0294</td> <td>11.62934 <td>51.07</td> </td></td></td>	5.91126 <td></td> <td></td> <td>0.146 <td>1.0294</td> <td>11.62934 <td>51.07</td> </td></td>			0.146 <td>1.0294</td> <td>11.62934 <td>51.07</td> </td>	1.0294	11.62934 <td>51.07</td>	51.07
				37	MAR <td>420.25 <td>89.11677 <td></td> <td></td> <td>0.146 <td>13.21142 <td>63.2114</td> <td>64.201</td> </td></td></td></td>	420.25 <td>89.11677 <td></td> <td></td> <td>0.146 <td>13.21142 <td>63.2114</td> <td>64.201</td> </td></td></td>	89.11677 <td></td> <td></td> <td>0.146 <td>13.21142 <td>63.2114</td> <td>64.201</td> </td></td>			0.146 <td>13.21142 <td>63.2114</td> <td>64.201</td> </td>	13.21142 <td>63.2114</td> <td>64.201</td>	63.2114	64.201
				38	ABR <td>420.25 <td>77.18338 <td></td> <td></td> <td>0.146 <td>11.26791 <td>64.919</td> <td>69.48</td> </td></td></td></td>	420.25 <td>77.18338 <td></td> <td></td> <td>0.146 <td>11.26791 <td>64.919</td> <td>69.48</td> </td></td></td>	77.18338 <td></td> <td></td> <td>0.146 <td>11.26791 <td>64.919</td> <td>69.48</td> </td></td>			0.146 <td>11.26791 <td>64.919</td> <td>69.48</td> </td>	11.26791 <td>64.919</td> <td>69.48</td>	64.919	69.48
SUB TOTAL							441.911.79						3.263.78

Acumulado Total	3,263.78
Acumulado Anterior	2,694.31
Deducción del mes	569.46

DEDUCCION DEL MES DE FEBRERO 2019 FORMULA POLINOMICA N°03

569.46

LUDWIG CARRASCO BUSTAMANTE
Ing. Supervisor - CIP 79040
CESEL S.A.

000020



VALORIZACIÓN N° 18 DEL 01 AL 28 DE FEBRERO DEL 2019
(PRECIOS UNITARIOS)



AMORTIZACION Y DEDUCCION QUE NO CORRESPONDE POR EL ADELANTO DE MATERIALES

OBRA: MEJORAMIENTO DE LOS SERVICIOS DEL DESEMBARCADERO PESQUERO ARTESANAL DE SUPE REGION LIMA, PROVINCIA DE BARRANCA, DISTRITO DE SUPE PUERTO
 PROP. FONDEPES
 CONTRAT. CONSORCIO MARITIMO DEL NORTE
 SUPERV. CESEL

ITEM	DESCRIPCION	lma	lmo	N° VALORIZACION	MES	lmo	VALORIZACION EJECUTADA	ADELANTO OTORGADO	ADELANTO DEFLACTADO A LA FECHA BASE	INDICE DE LA FORMULA POLINOMICA	MONTO UTILIZABLE EN LA VALORIZACION	MONTO UTILIZADO ACUMULADO	DEDUCCION		
FORMULA POLINÓMICA N° 01:															
MATERIALES															
0202000007	CEMENTO PORTLAND TIPO V	418 10	418 10	01	SET	418 10	-	-	-	0 146	-	-	-		
23				02	OCT	418 10	844,367 40	-	-	-	0 146	123,276 16	123,276 16	-	-
				03	NOV	418 10	362,242 78	-	-	-	0 146	67,287 45	190,563 63	-	-
				04	DEC	418 10	1,197,259 40	-	-	-	0 146	173,339 95	363,903 51	-	-
				05	JAN	418 10	328,036 47	-	-	-	0 146	47,863 63	411,767 13	-	-
				06	FEB	418 10	153,293 00	-	-	-	0 146	22,260 75	434,027 88	-	-
				07	MAR	439 25	-75,269 47	-	-	-	0 146	-30,899 34	403,128 54	555 91	-
				08	ABR	439 25	29,558 99	-	-	-	0 146	4,315 61	407,444 17	240 51	-
				09	MAY	439 25	21,543 47	-	-	-	0 146	3,140 15	410,584 32	157 03	-
				10	JUN	439 25	87,013 77	-	-	-	0 146	12,704 01	423,288 33	642 84	-
				11	JUL	439 25	47,706 78	-	-	-	0 146	6,896 19	430,184 52	352 34	-
				12	AUG	439 25	20,567 19	-	-	-	0 146	3,022 81	433,207 33	61 00	-
				13	SEP	439 25	-	-	-	-	0 146	-	433,207 33	-	-
				14	OCT	439 25	-	-	-	-	0 146	-	433,207 33	-	-
				15	NOV	439 25	110,459 82	-	-	-	0 146	16,127 13	449,334 46	815 91	-
				16	DEC	439 25	22,978 88	-	-	-	0 146	3,254 92	452,589 38	169 71	-
				17	ENE	439 25	-	-	-	-	0 146	-	452,589 38	-	-
				18	FEB	439 25	178,769 65	-	-	-	0 146	28,100 37	480,689 75	1,330 31	-
SUB TOTAL							3,348,320.22	-	-	-	-	-	3,272.75		

0202000008	ACERO DE CONSTRUCCION CORRUGADO	467 17	431 87	01	SET	467 17	-	-	-	0 22	-	-	-		
03				02	OCT	467 17	844,367 40	-	-	-	0 22	184,914 27	184,914 27	-	-
				03	NOV	467 17	362,242 78	-	-	-	0 22	85,901 17	270,815 44	546 26	-
				04	DEC	467 17	1,197,259 40	-	-	-	0 22	200,009 69	470,825 13	1,490 97	-
				05	JAN	472 43	309,036 47	-	-	-	0 22	71,840 43	542,665 56	864 97	-
				06	FEB	475 87	153,293 00	-	-	-	0 22	39,871 17	582,536 73	1,319 29	-
				07	MAR	502 31	-75,269 47	-	-	-	0 22	-36,494 01	546,042 72	1,341 64	-
				08	ABR	506 47	29,558 99	-	-	-	0 22	8,473 42	554,566 14	599 09	-
				09	MAY	501 98	31,943 47	-	-	-	0 22	4,955 98	559,522 12	309 49	-
				10	JUN	513 58	87,013 77	-	-	-	0 22	16,143 09	575,665 21	2,057 17	-
				11	JUL	508 81	47,706 78	-	-	-	0 22	10,476 49	586,141 70	1,011 06	-
				12	AUG	512 37	20,567 19	-	-	-	0 22	4,524 78	590,666 48	473 67	-
				13	SEP	525 48	-	-	-	-	0 22	-	590,666 48	-	-
				14	OCT	527 89	-	-	-	-	0 22	-	590,666 48	-	-
				15	NOV	531 71	110,459 82	-	-	-	0 22	24,201 10	614,867 58	3,231 64	-
				16	DEC	531 71	22,978 88	-	-	-	0 22	5,055 35	619,922 93	759 49	-
				17	ENE	542 08	-	-	-	-	0 22	-	619,922 93	-	-
				18	FEB	537 43	178,769 65	-	-	-	0 22	39,339 30	659,262 23	6,399 40	-
SUB TOTAL							3,348,320.22	-	-	-	-	-	14,605.41		
SUB TOTAL							-	-	-	-	-	-	-	17,878.16	

Acumulado Total	17,878.16
Acumulado Anterior	10,159.45
Deducción del mes	7,718.72

DEDUCCION DEL MES DE FEBRERO 2019 FORMULA POLINÓMICA N°01 7,718.72

FORMULA POLINÓMICA N° 02:															
MATERIALES															
0202000007	CEMENTO PORTLAND TIPO V	418 10	418 10	01	SET	418 10	-	-	-	0 21	-	-	-		
23				02	OCT	418 10	-	-	-	-	0 21	-	-	-	-
				03	NOV	418 10	697,570 31	-	-	-	0 21	176,374 82	176,374 82	-	-
				04	DEC	418 10	138,517 05	-	-	-	0 21	28,911 56	205,286 38	-	-
				05	JAN	418 10	53,230 73	-	-	-	0 21	11,009 71	216,296 09	-	-
				06	FEB	418 10	253,267 84	-	-	-	0 21	52,899 67	269,195 76	-	-
				07	MAR	439 25	246,884 19	-	-	-	0 21	51,351 01	320,546 77	2,659 09	-
				08	ABR	439 25	51,812 01	-	-	-	0 21	10,770 90	331,317 67	545 16	-
				09	MAY	439 25	121,196 47	-	-	-	0 21	25,308 67	356,626 34	1,275 22	-
				10	JUN	439 25	134,191 85	-	-	-	0 21	27,911 91	384,538 25	1,411 05	-
				11	JUL	439 25	158,033 19	-	-	-	0 21	41,165 60	425,703 85	2,099 91	-
				12	AUG	439 25	104,581 60	-	-	-	0 21	21,782 97	447,486 82	1,600 40	-
				13	SEP	439 25	10,478 58	-	-	-	0 21	2,170 54	449,657 36	110 25	-
				14	OCT	439 25	69,354 83	-	-	-	0 21	14,425 80	464,083 16	759 71	-
				15	NOV	439 25	13,937 26	-	-	-	0 21	2,838 05	466,921 21	140 03	-
				16	DEC	439 25	271,189 75	-	-	-	0 21	66,467 42	533,388 63	2,663 43	-
				17	JAN	439 25	32,737 6 5	-	-	-	0 21	6,669 43	540,058 06	344 45	-
				18	FEB	439 25	17,206 85	-	-	-	0 21	3,579 03	543,637 09	811 05	-
SUB TOTAL							2,574,302.08	-	-	-	-	-	13,379.91		

[Handwritten Signature]
 LUDWIG CARRASCO BUSTAMANTE
 Ing. Supervisor - CIP 79040
 CESEL S.A.



VALORIZACIÓN N° 18 DEL 01 AL 28 DE FEBRERO DEL 2019 (PRECIOS UNITARIOS)



Contrato N° 823-2019- FONDERES Ejecución de la Obra: MEJORAMIENTO DE LOS SERVICIOS DEL DESEMBAICADERO PESQUERO ARTESANAL DE SUPE, REGION LIMA, PROVINCIA DE BARRANCA, DISTRITO DE PUERTO



Fórmula Polinómica

Presupuesto: MEJORAMIENTO DE LOS SERVICIOS DEL DESEMBAICADERO PESQUERO ARTESANAL DE SUPE, REGION LIMA, PROVINCIA DE BARRANCA, DISTRITO DE PUERTO

Fecha Presupuesto: 17/03/2017
Propietario: FONDERES
Contratista: CONSORCIO MARITIMO DEL NORTE
Supervisión: CESEL
Formula: EDIFICIO EN TIERRA INSTALACIONES SANITARIAS

$$K = 0.331^{*(M/Mo)} + 0.168^{*(C/Co)} + 0.211^{*(T/Tt)} + 0.167^{*(M/Mo)} + 0.123^{*(D/Do)}$$

Área Geográfica:

Monomio	Factor	(%)	Símbolo	Índice	Descripción	C.BASE		C. A.D		Val. 1		Val. 2		Val. 3		Val. 4		Val. 5		Val. 14		Val. 15		Val. 16		Val. 17		Val. 18			
						Mar-17		Ago-17		Ago-17		Set-17		Oct-17		Nov-17		Dic-17		Set-18		Oct-18		Nov-18		Dic-18		Ene-19			
						IU	COEFIC	IU	COEFIC	IU	COEFIC	IU	COEFIC	IU	COEFIC	IU	COEFIC	IU	COEFIC	IU	COEFIC	IU	COEFIC	IU	COEFIC	IU	COEFIC	IU	COEFIC	IU	COEFIC
1	0.331	100.00%	M	47	MANO DE OBRA INC. LIEVES SOCIALES	415.34	0.331	416.90	0.332	580.90	0.463	580.90	0.463	580.90	0.463	580.90	0.463	580.90	0.463	602.11	0.480	602.11	0.480	602.11	0.480	602.11	0.480	602.11	0.480	600.40	0.478
2	0.168	100.00%	C	23	CEMENTO PORTLAND TIPO V	563.25	0.168	580.90	0.173	418.10	0.125	418.10	0.125	418.10	0.125	418.10	0.125	418.10	0.125	439.25	0.131	439.25	0.131	439.25	0.131	439.25	0.131	439.25	0.131	439.25	0.131
3	0.211	100.00%	T	72	TUBERIA DE PVC PARA AGUA	408.62	0.211	410.19	0.212	416.90	0.215	418.93	0.215	428.35	0.220	425.95	0.220	428.06	0.220	436.21	0.225	437.54	0.226	437.54	0.226	437.54	0.226	437.54	0.226	437.54	0.226
4	0.167	100.00%	M	48	MASQUILLA Y EQUIPO PROTECTOR	293.92	0.167	292.38	0.166	366.02	0.209	366.18	0.209	363.30	0.206	363.07	0.206	363.24	0.206	372.23	0.211	370.70	0.211	370.70	0.211	370.70	0.211	370.70	0.211	369.95	0.210
5	0.123	100.00%	D	30	DOLAR GENERAL PERUANO	444.52	0.123	444.64	0.123	462.48	0.128	464.58	0.129	467.81	0.129	466.87	0.129	466.75	0.129	486.67	0.135	490.47	0.138	497.53	0.138	494.24	0.137	489.58	0.135		
K =						1.000		1.006		1.139		1.140		1.144		1.143		1.143		1.182		1.183		1.183		1.183		1.182		1.178	

Formula: EDIFICIO EN TIERRA EQUIPAMIENTO

$$K = 0.912^{*(M/Mo)} + 0.082^{*(D/Do)}$$

Área Geográfica:

Monomio	Factor	(%)	Símbolo	Índice	Descripción	C.BASE		C. A.D		Val. 1		Val. 2		Val. 3		Val. 4		Val. 5		Val. 14		Val. 15		Val. 16		Val. 17		Val. 18	
						Mar-17		Ago-17		Ago-17		Set-17		Oct-17		Nov-17		Dic-17		Set-18		Oct-18		Nov-18		Dic-18		Ene-19	
						IU	COEFIC	IU	COEFIC	IU	COEFIC	IU	COEFIC	IU	COEFIC	IU	COEFIC	IU	COEFIC	IU	COEFIC	IU	COEFIC	IU	COEFIC	IU	COEFIC	IU	COEFIC
1	0.912	100.00%	M	49	MAQUINARIA Y EQUIPO IMPORTADO	293.92	0.912	292.38	0.907	282.36	0.807	293.03	0.909	293.18	0.910	292.27	0.907	293.24	0.910	304.74	0.946	307.20	0.953	311.07	0.965	311.15	0.965	309.58	0.962
2	0.082	100.00%	D	30	DOLAR GENERAL PERUANO	463.36	0.082	462.48	0.088	462.48	0.088	464.53	0.088	467.81	0.089	466.87	0.088	466.75	0.089	486.67	0.092	490.47	0.093	497.53	0.094	494.24	0.094	489.58	0.093
K =						1.000		0.995		0.995		0.997		0.999		0.995		0.999		1.038		1.044		1.050		1.059		1.055	





Formula: IMPACTO AMBIENTAL

$$K = 0.338^{*(M/Mo)} + 0.662^{*(M/Mo)}$$

Área Geográfica:

Monomio	Factor	(%)	Símbolo	Índice	Descripción	C.BASE		C. A.D		Val. 1		Val. 2		Val. 3		Val. 4		Val. 5		Val. 14		Val. 15		Val. 16		Val. 17		Val. 18			
						Mar-17		Ago-17		Ago-17		Set-17		Oct-17		Nov-17		Dic-17		Set-18		Oct-18		Nov-18		Dic-18		Ene-19			
						IU	COEFIC	IU	COEFIC	IU	COEFIC	IU	COEFIC	IU	COEFIC	IU	COEFIC	IU	COEFIC	IU	COEFIC	IU	COEFIC	IU	COEFIC	IU	COEFIC	IU	COEFIC	IU	COEFIC
1	0.338	100.00%	M	47	MANO DE OBRA	563.25	0.338	580.90	0.349	580.90	0.349	580.90	0.349	580.90	0.349	580.90	0.349	580.90	0.349	602.11	0.361	602.11	0.361	602.11	0.361	602.11	0.361	602.11	0.361	600.40	0.360
2	0.662	100.00%	M	48	MAQUINARIA Y EQUIPO IMPORTADO	365.67	0.662	366.02	0.663	366.02	0.663	366.18	0.663	363.30	0.658	363.07	0.657	363.24	0.658	372.23	0.674	370.70	0.671	370.70	0.671	370.70	0.671	370.70	0.671	369.95	0.670
K =						1.000		1.011		1.011		1.012		1.006		1.006		1.006		1.035		1.032		1.032		1.032		1.030			

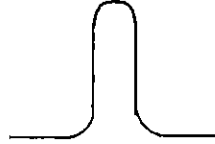
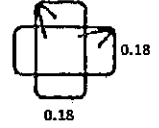
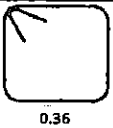
[Signature]
LUDWIG GARRASCO BUSTAMANTE
 Ing. Supervisor - CIP 79040
 CESEL S.A.

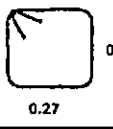
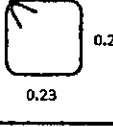
ELEMENTO		DISEÑO DE ACERO			CANTIDAD ELEMENTOS		LONGITUD SEGÚN DIÁMETRO					
DENOMINACIÓN	VECES	DETALLE	DIAM.	LONGITUD	PARCIAL	TOTAL	1/4	3/8	1/2	5/8	3/4	1
LONGITUDINALES	12		1	13	1	156						156
	4		3/4	13	1	52					52	
	8		1/2	1.3	1	10.4			10.4			
	2		3/4	1.4	1	2.8					2.8	
Estribos 1	190		1/2	1.38	1	262.2			262.2			
ESTRIBOS	95		1/2	1.67	1	158.65			158.65			
ESTRIBOS	1		1/2	1.5	1	1.5			1.5			
ESTRIBOS	1		1/2	1.38	1	1.38			1.38			
ESTRIBOS	1		1/2	1.22	1	1.22			1.22			
LONGITUD TOTAL (ML)							0.00	0.00	435.35	0.00	54.80	156.00
PESO UNITARIO (KG/ML)							0.25	0.56	0.99	1.55	2.24	3.97
PESO PARCIAL (KG)							0.00	0.00	431.00	0.00	122.48	619.32
N° de Pilotes					20		1172.79					
							23,455.89					



 LUDWIG CARRASCO BUSTAMANTE
 Ing. Supervisor - CIP 79040
 CESEL S.A.

000017

CODIGO	DESCRIPCIÓN	UND.	CANT.	LARGO	ALTO	ANCHO	SUB TOTAL	TOTAL
	ENCOFRADO DE PILOTE (L=13.00 m.)	m2	20					260.00
			2	13.00	-	0.50	13.00	

 LUDWING CARRASCO BUSTAMANTE
 Ing. Supervisor - CIP 79040
 CESEL S.A.

000013

CODIGO	DESCRIPCIÓN	UND.	CANT.	LARGO	ANCHO	ALTURA	SUB TOTAL	TOTAL
	CONCRETO DE PILOTE (L=13.00 m.) f'c=350 Kg/cm2	m3	20					65.00
	PILOTE		1	13.00	0.50	0.50	3.25	

 EDWING CALRASCO BUSTAMANTE
 Ing. Supervisor - CIP 79040
 S.A.

000015

PLANILLA DE METRADOS
ESTRUCTURAS
MESA DE OVALINES

DESCRIPCIÓN DEL ELEMENTO	CANTIDAD	CONCRETO				ENCOFRADO Y DESENCOFRADO			ACERO				LONGITUD ACERO						PROTOCOLO
		DIMENSIÓN (M)		TOTAL (M3)	MEDIDAS		TOTAL (M2)	Φ	CANT.	LONG.	1/4"	3/8"	1/2"	5/8"	3/4"	1"	1 3/8"		
		L	A		H	P												H	
ADMINISTRATIVAS																		6 & 8	
Mesa de Ovalin SSJH Varones																			
N° Mesas	1.00	3.35	0.55	0.0365	0.16	3.36	0.55	1.85	1/2"	2	1	4.6					9.20		
	1.00	0.885	0.55	0.075	0.04	0.885	1.1	0.97											
N° Ovalinas	4.00	0.5	0.35	0.085	-0.06	0.5	0.35	-0.70	3/8"	5	1	0.94		2.69					
									3/8"	8	1	0.61		2.73					
									3/8"	4	1	1.55		3.47					
									3/8"	4	4	0.14		1.23					
									3/8"	1	4	0.7		1.57					
									3/8"	2	4	0.42		1.88					
									3/8"	1	4	0.32		0.72					
									3/8"	15	1	0.70		5.65					
SUBTOTAL		0.14				2.12			LONGITUD TOTAL				0						
TOTAL									PESO DE VARILLAS				0.25						
ACUMULADO TOTAL ACTUAL									ACERO KG.				202						
									ACUMULADO TOTAL ACTUAL				29.59						

LUDWIG CARRASCO BUSTAMANTE
 Ing. Supervisor - CIP 79040
 CESEL S.A.

000017

PLANILLA DE METRADOS
ESTRUCTURAS
ZAPATAS

DESCRIPCIÓN DEL ELEMENTO UBICACIÓN	CANTIDAD	CONCRETO			ENCUADRADO Y DESENCUADRADO		ACERO			LONGITUD ACERO							PROTOCOLO								
		DIMENSIÓN (M)			MEDIDAS		φ	CANT.	LONG.	1/4"	5/8"	1/2"	5/8"	3/4"	1"	1 3/8"									
		L	A	H	TOTAL (M3)	P												H	TOTAL (M2)						
Feb-19 Casetas de Seguridad N° 02	4	1	1	0.5	2.00	9.47	0.5	4.74	1/2"	5	1.15													B09-04 (ENCUADRADO)	
									1/2"	5	1.15														B09-05 (ACERO)
																									B09-11 (CONCRETO)
SUBTOTAL					2.00			4.74	LONGITUD TOTAL PISO DE VARILLAS			0.25	0.56	46.00	0.99	1.53	2.235	3.973	7.907						
TOTAL					2.00			4.735	ACERO EN KG.					45.72	0.00										

 EDWIN CARRASCO BUSTAMANTE
 Ing. Supervisor - CIP 79040
 S.A.

000012

PLANILLA DE METRADOS										
MOVIMIENTO DE TIERRA										
02.03.01 - CORTE MASIVO M3 - CONTRACTUAL										
FEBRERO										
UBICACIÓN/DESCRIPCION	BLOQUE	UND	L	A	H	PARCIAL	TOTAL		PROTOCOLO	
Muro de cerco Eje: G	10	M3	11.9	0.9	2.3	24.63		Metrado Febrero 2019	B10-02	
Caseta de Seguridad 2 - Eje: G - F	9	M3	2.55	2.22	2.1	11.89		Metrado Febrero 2019	B09-02	
Muro de cerco - PIAR	11	M3	34.11	0.9	2.1	64.47		Metrado Febrero 2019	B11-02	
Cistema Frio	12	M3	8.00	3.3	2.82	74.45		Metrado Febrero 2019	B12-02	
							175.44			



LUDWIG CARRASCO BUSTAMANTE
 Ing. Supervisor - CIP 79040
 CESEL S.A.

111111

PLANILLA DE METRADOS ESTRUCTURAS CIMENTO CORRIDO																		
DESCRIPCIÓN		CONCRETO				ENCOFRADO Y DEENCOFRADO			ACERO			LONGITUD ACERO						
DESCRIPCIÓN DEL ELEMENTO	CANTIDAD	DIMENSIÓN (M)			TOTAL (M3)	MEDIDAS		TOTAL (M2)	φ	CANT.	LONG.	1/4"	3/8"	1/2"	5/8"	3/4"	1"	1 3/8"
UBICACIÓN		L	A	H		P	H											

CERCO PERIMÉTRICO FEBRERO 2019

ESTRUCTURAS CIMENTO CORRIDO FEBRERO											
CONCRETO M3							ENCOFRADO M2				
UBICACIÓN/DESCRIPCIÓN	BLOQUE	L	A	H	PARCIAL	TOTAL	VECES	L	H	PARCIAL	TOTAL
Muro de cerco Eje: G	10	12.53	0.9	0.95	10.71		2.00	12.53	1.00	25.06	
Caseta de Seguridad 2 - Eje: G - F	9	2.24	0.6	0.5	0.67						

Protocolos
B10-06 (ENCOFRADO)
B10-08 (CONCRETO)
B09-06 Y B09-10 (CONCRETO)

11.39

NO SE VALORIZÓ POR FALTA DE METRADO

25.06

02.04.02.02 ENCOFRADO Y DEENCOFRADO CIMENTO CERCO PERIMETRICO

LUDWING CARRASCO BUSTAMANTE
 Ing. Supervisor - CIP 79040
 CESEL S.A.

000010

**PLANILLA DE MÉTRADOS
ESTRUCTURAS
SOBRECIMENTOS**

DESCRIPCIÓN UBICACIÓN	CANTIDAD	CONCRETO			ENCOFRADO Y DESENCOFRADO		ACERO			LONGITUD ACERO						
		DIMENSIÓN (M)			TOTAL (M3)	MEDIDAS		♦	CANT.	LONG.	1/4"	3/8"	1/2"	3/4"	1"	1 1/8"
		L	A	H		L	H									

02.04.03 SOBRECIMENTOS - FEBRERO 2019
 02.04.03.01 CONCRETO SOBRECIMENTOS $f_c=175 \text{ kg/cm}^2$ m3
 02.04.03.02 ENCOFRADO Y DESENCOFRADO DE SOBRECIMIEN m2

ESTRUCTURAS SOBRE CIMIENTO CORRIDO FEBRERO																									
CONCRETO M3							ENCOFRADO M2					ACERO													
UBICACIÓN/DESCRIPCIÓN	BLOQUE	L	A	H	PARCIAL	TOTAL	VECES	L	H	PARCIAL	TOTAL	♦	CANT.	LONG.	0.39		0.58		1.00		3/8"	3/4"	1"	1 1/8"	
															3/8"	1/2"	3/8"	1/2"	3/8"	1/2"					
Muro de cerco Ept G	10	10.55	0.125	0.9	1.19		2	10.55	0.9	18.99			3/8"	43	2.1			60.57							
													3/8"	7	12.35			45.41							
Caseta de Seguridad 2 - Ept G - F	9	6.77	0.125	1.25	1.06		2	6.77	1.25	16.93			3/8"	27	1.95			29.43							
													3/8"	8	9.7			38.75							
2.24						35.92						167.44													

PROTOS
 810-05 (ACERO)
 810-06 (ENCOFRADO)
 810-09 (CONCRETO)
 809-05 (ACERO)
 809-04 (ENCOFRADO)
 809-12 (CONCRETO)

NO SE VALORIZO POR FALTA DE METRADO



LUDWING CARRASCO BUSTAMANTE
 Ing. Supervisor - CIP 79040
 CESEL S.A.

999999

ESTRUCTURAS
COLUMNETAS

FEBRERO

PROTOCOLO	UBICACIÓN/DESCRIPCIÓN	BLOQUE	CONCRETO M3							ENCOFRADO M2					ACERO											
			COLUMNA	VECES	L	A	H	PARCIAL	TOTAL	VECES	L	H	PARCIAL	TOTAL	φ	VECES	CANT.	LONG.	0.39			1.00				
																			1/4"	3/8"	1/2"	3/8"	1/2"	1"		
B02-03 (Concreto)	Muro de cerco Eje: A / 4-7	2	C1	3	0.3	0.15	3.4	0.48		1	0.65	3.4	2.210		1/2"	3	4	1.85								
B02-04 (Encofrado)										2	0.5	3.4	3.40		3/8"	3	32	0.85			45.70					
B02-05 (Acero)																										
B01-14 (Concreto)	Muro de cerco - Eje: 1	1	C1	9	0.3	0.15	3.4	1.28		4	0.475	3.4	6.46		1/2"	9	4	5.1							183.97	
B01-18 (Encofrado)										5	0.65	3.4	11.06		3/8"	9	27	0.8			108.26					
B01-19 (Acero)																										
B07-02 (Concreto)	Muro de cerco - Eje: F - B	7	C1	3.00	0.30	0.15	3.35	0.45		3	0.65	3.35	6.53		1/2"	5	4	5.1								107.00
B07-03 (Encofrado)				C1A	2.00	0.30	0.15	3.35	0.20		2	0.775	3.35	6.19		3/8"	5	27	0.8			60.48				
B07-04 (Acero)																										
B06-03 (Concreto)	Muro de cerco Eje: B - A	6	C1	4	0.30	0.15	3.35	0.20		4	0.65	3.35	8.71		1/2"	6	4	5.1								122.40
B06-04 (Encofrado)				C2	1	0.25	0.25	3.35	0.21		1	0.75	3.35	2.61		3/8"	4	27	0.8			48.38				
B06-05 (Acero)				C3	1	0.25	0.25	3.35	0.21		1	0.75	3.35	2.61			2	27	0.85			24.20				
B05-21 (Concreto)				C1a	1	0.30	0.15	3.35	0.15		1	0.75	3.35	2.61		1/2"	6	4	5.10							163.20
B05-20 (Encofrado)	Muro de cerco Eje: H - L	5	C1b	3	0.30	0.15	3.35	0.45		3	0.42	3.35	4.22			2	6	5.10							e1.20	
B05-20 (Encofrado)				C1c	3	0.30	0.15	3.35	0.45		3	0.48	3.35	6.63		3/8"	7	27	0.80			64.67				
B05-10 (Acero)				C2	1	0.25	0.25	3.35	0.21		1	0.75	3.35	2.61			1	27	0.85			17.55				
B05-10 (Acero)				C3	1	0.12	←Arco	3.35	0.40		1	1.25	3.35	4.19			2	27	1.40			42.34				
B03-03 (Concreto)				C4	1	0.50	0.25	3.35	0.42		1	1.25	3.35	4.19		1/2"	4	4	5.1							81.40
B03-04 (Encofrado)	Muro de cerco Eje: O - S	3	C1	4	0.30	0.15	3.35	0.60		4	0.65	3.35	8.71		3/8"	4	27	0.8			46.50					
B03-05 (Acero)																										
B04-03 (Concreto)	Muro de cerco - Eje: A	4	C1	3	0.30	0.15	3.35	0.45		3	0.65	3.35	6.53		1/2"	3	4	5.10								61.20
B04-04 (Encofrado)				C2	1	0.25	0.25	3.35	0.21		1	0.75	3.35	2.61			1	4	5.10							25.40
B04-05 (Acero)				C1a	1	0.25	0.15	3.35	0.13		1	0.43	3.35	1.42			1	4	5.10							20.40
															3/8"	3	27	0.80			36.20					
																1	27	0.85			12.65					
																1	27	0.66			9.98					
									7.00					91.91						535.49			874.20			
									NO SE VALORIZÓ POR FALTA DE METRADO					NO SE VALORIZÓ POR FALTA DE METRADO						SE VALORIZÓ EN LA PARTIDA DE VIGA DE CIMENTACIÓN						

LUDWIG CAFRASCO BUSTAMANTE
 Ing. Supervisor - CIP 78040
 CESEL S.A.

800008

ESTRUCTURAS
VIGUETAS

FEBRERO

PROTOCOLO	UBICACIÓN/DESCRIPCION	BLOQUE	CONCRETO M3						ENCOFRADO M2					ACERO						
			VECES	L	A	H	PARCIAL	TOTAL	VECES	L	H	PARCIAL	TOTAL	φ	VECES	CANT.	LONG.	1/4"	3/8"	1/2"
B02-08 (Concreto)	Muro de cerco Eje: A / 4-7	2	1	7.13	0.125	0.135	0.12		2	7.355	0.135	1.99		3/8"	1	2	7.33		8.21	
B02-07 (Encofrado)															1/4"	1	36	0.2	2.81	
B02-06 (Acero)																				
B01-18 (Concreto)	Muro de cerco - Eje: T	1	1	22.75	0.125	0.135	0.38		2	22.75	0.135	6.14		3/8"	1	2	23.96		26.84	
B01-17 (Encofrado)															1/4"	1	107	0.2	8.35	
B01-05 (Acero)																				
B07-07 (Concreto)	Muro de cerco - Eje: F - B	7	1	12.17	0.125	0.135	0.21		1	12.17	0.135	1.64		3/8"	1	2	13.1		14.67	
B07-06 (Encofrado)															1/4"	1	61	0.2	4.76	
B07-05 (Acero)																				
B06-08 (Concreto)	Muro de cerco Eje: B - A	6	1	15.02	0.13	0.14	0.25		2	15.02	0.135	4.06		3/8"	1	2	15.82		17.72	
B06-07 (Encofrado)															1/4"	1	68	0.2	5.30	
B06-06 (Acero)																				
B05-23 (Concreto)	Muro de cerco Eje: H - L	5	1	21.08	0.13	0.14	0.36		2	21.08	0.135	5.69		3/8"	1	2	22.48		25.18	
B05-22 (Encofrado)															1/4"	1	100	0.2	7.80	
B05-10 (Acero)																				
B04-08 (Concreto)	Muro de cerco - Eje: A	4	1	11.15	0.13	0.14	0.19		2	11.15	0.135	3.01		3/8"	1	2	12.16		13.62	
B04-07 (Encofrado)															1/4"	1	55	0.2	4.29	
B04-06 (Acero)																				
B03-08 (Concreto)	Muro de cerco Eje: O - S	3	1.00	8.05	0.13	0.14	0.14		2	8.05	0.135	2.17		3/8"	1	2	8.4		9.41	
B03-07 (Encofrado)															1/4"	1	42	0.2	3.28	
B03-06 (Acero)																				
								1.64					24.70				36.58	115.64	0.00	

 LUDWIG CARRASCO BUSTAMANTE
 Ing. Supervisor - CIP 79040
 CGEL S.A.

700007

ARQUITECTURA							
MURO LADRILLO							
FEBRERO DEL 2019							
ASENTADO DE LADRILLO KK= 0.15m							
PROTOCOLO	UBICACIÓN/DESCRIPCIÓN	BLOQUE	VECES	L	H	PARCIAL	TOTAL
B02-02	Muro de cerco Eje: A / 4'-7'	2	1	3.73	2.65	9.88	PATIO DE REDES
			1	3.4	2.65	9.01	
B01-13	Muro de cerco - Eje: T al N	1	4	3.05	2.7	32.94	ZONA DE PLAYA
			1	3.07	2.7	8.29	
			1	3.05	2.7	8.24	
			1	3.08	2.7	8.32	
			1	2.34	2.63	6.15	
B06-02	Muro de cerco Eje: B - A	6	1	2.89	2.63	7.60	ENAPU
			1	2.76	2.88	7.95	
			2	2.94	2.88	16.93	
			1	2.49	2.5	12.45	
B03-02	Muro de cerco Eje: O - S	3	1	2.47	2.5	6.18	POR CASETA 1
			1	3.11	2.73	8.49	
B04-02	Muro de cerco - Eje: A	4	1	3.07	2.73	8.38	ENAPU-PATIO DE GRAVA
			1	3.14	2.73	8.57	
			1	0.76	2.73	2.07	
			1	10.6	2.55	27.03	
B10-10	Muro de cerco Eje: G	10					CERCO DIVISORIO

188.49

 LUDWING CAJRASCÓ BUSTAMANTE
 Ing. Supervisor - CIP 79040
 CESEL S.A.

900000

ARQUITECTURA
TARRAJEO M2

FEBRERO

PROTOCOLO	UBICACIÓN/DESCRIPCIÓN	BLOQUE	TARRAJEO DE MUROS					TARRAJEO DE COLUMNAS / PLACAS								
			VECES	L	H	PARCIAL	TOTAL	VECES	AREA	L	H	PARCIAL	TOTAL			
802-09	CERCO PERIMETRICO															
	Muro de cerco - Eje: T	1	Interior	1	21.4	3.6	77.04				4		0.48	3.60	6.84	ZONA PLAYA
			Exterior	1	21.4	3.6	77.04				5		0.65	3.60	11.70	
	Muro de cerco - Eje: A	2	Interior	1	7.13	3.4	24.24				1		0.65	3.4	2.210	PATIO REDES
			Exterior	1	7.12	3.55	25.28				2		0.5	3.55	3.55	
			Interior	1	18.49	3.5	64.70				C1a	1	0.75	3.5	2.63	
			Exterior	1	18.49	3.5	64.70				C1b	3	0.42	3.5	4.41	
	Muro de cerco Eje: H - L	5									C1c	3	0.65	3.5	6.83	CASETA 2 A PUERTA 1
											C2	1	0.75	3.5	2.63	
											C3	1	1.25	3.5	4.38	
											C4	1	1.25	3.5	4.38	
	Muro de cerco Eje: O - S	3	Interior	1	7.45	3.5	26.08				4		0.65	3.50	9.10	CASETA 1 A TANQUE ELEVADO
			Exterior	1	7.45	3.5	26.08									
	Muro de cerco - Eje: F - B	7	Interior	1	12.2	3.5	42.70				C1	3	0.65	3.5	6.83	ESTACIONAMIENTO
			Exterior	1	12.2	3.5	42.70				C1A	2	0.775	3.5	5.43	
			Interior	1	13.87	3.73	51.74				C1	4	0.65	3.73	9.70	
	Muro de cerco Eje: B - A	6	Exterior	1	13.87	3.73	51.74				C2	1	0.75	3.73	2.80	ENAPU
											C3	1	0.75	3.73	2.80	
	Muro de cerco - Eje: A	4	Interior	1	10.08	3.73	37.60				C1	3	0.65	3.73	7.27	PATIO DE GRAVAS
			Exterior	1	10.08	3.73	37.60				C2	1	0.75	3.73	2.80	
										C1a	1	0.43	3.73	1.59		
							649.21								97.83	

LUDWING CARRASCO BUSTAMANTE
 Ing. Supervisor - CIP 79040
 CESEL S.A.

000005

DESCRIPCIÓN		TARRAJEO			
DESCRIPCIÓN DEL ELEMENTO	CANTIDAD	DIMENSIÓN (M)			TOTAL (M2)
UBICACIÓN		L	A	H	
Feb-19					
Feb-19	MURO EXTERIOR EJE 7	1.00	103.96		103.96

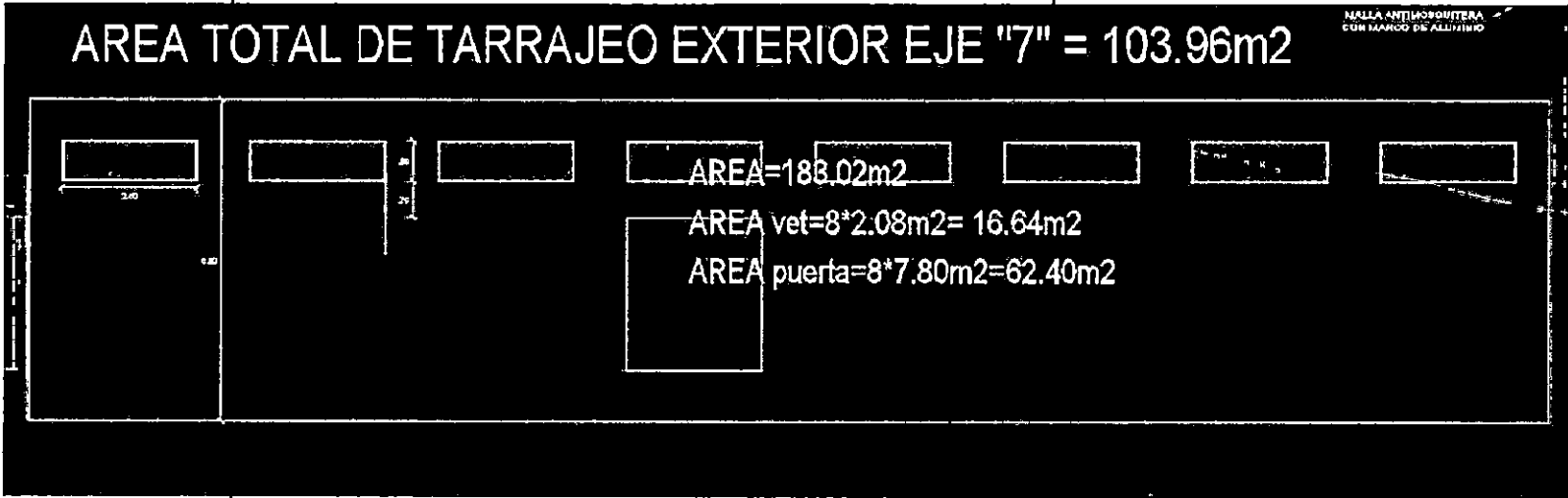

[Signature]
LUDWIG CARRASCO BUSTAMANTE
 Ing/Supervisor - CIP 79040
 CESEL S.A.

000007

**ARQUITECTURA
IMPRIMANTE 1º MANO**

FEBRERO

DESCRIPCION	Und	Veces	Cantidad	Area	Long.	Ancho	Altura	Parcial	Total
DESINFECCION									
Imprimante 1º Mano - CIELO RASO	m2								234.49
Pasillo		1	1	42.90				42.90	
Lavandería - Entrega de Uniforme		1	1	35.66				35.66	
Vestuario de hombre		1	1	17.00				17.00	
SS.HH Hombres		1	1	20.97				20.97	
SS.HH Mujeres		1	1	20.20				20.20	
Vestuario de Mujeres		1	1	17.00				17.00	
Grupo Electrogeno		1	1	19.39				19.39	
SubEstacion Electrica		1	1	20.01				20.01	
Maestranza		1	1	41.36				41.36	
Cuarto de Tableros									
Deposito de Limpieza									
Imprimante 1º Mano - Muro Exterior	m2								144.64
Eje: S (corte C-C)		1	1	18.58				18.58	
Eje: T / 2 - 17"		1	1	20.43	38.55		3.80	126.06	
ZONA DE AREAS SOCIALES									
Imprimante 1º Mano - CIELO RASO	m2								38.00
Taller de redes		1	1	38.00				38.00	
Imprimante 1º Mano - Muro Exterior	m2								65.30
Eje: 4' (corte 1-1)		1	1	18.93				18.93	
Eje: D/ 1 - 4		1	1	14.67				14.67	
Eje: 1'A-D		1	1	31.70				31.70	
ZONA DE FRIO									
Imprimante 1º Mano - CIELO RASO	m2								249.30
Cuarto de Maquinas									
Oficinas de Mantenimiento		1	1	216.11				216.11	
Pasillo									
Cuarto de hielo									
Guardiana		1	1	33.19				33.19	
Imprimante 1º Mano - Muro Interior	m2								113.56
Eje: G		1	6	13.94				83.64	
Eje: F		1	1		14.38		1.20	17.26	
		1	1		2.58		3.50	9.03	
		1	1		3.30		1.10	3.63	
									845.29
									169.06

Sólo el 50% por lijado y 1º mano de imprimante

Imprimante 1º Mano - CIELO RASO	521.79	260.895
Imprimante 1º Mano - Muro Exterior	209.94	104.97
Imprimante 1º Mano - Muro Interior	113.56	56.778
	845.29	

LUDWING CARRASCO BUSTAMANTE
 Ing. Supervisor - CIP 79040
 SEEL S.A.

000002

ARQUITECTURA

DERRAMES

FEBRERO

TARRAJEO DE MUROS

PROTOCOLO	UBICACIÓN/DESCRIPCIÓN	BLOQUE	e=	CANTIDAD	VECES	L	PARCIAL	TOTAL
B01-19	Muro de cerco - Eje: I	1	e= 0.15		1	21.04	21.04	
B02-19	Muro de cerco - Eje: A	2	e= 0.15		1	7.58	7.58	
B05-24	Muro de cerco Eje: H - L	5	e= 0.15		1	21.08	21.08	
B03-09	Muro de cerco Eje: O - S	3	e= 0.15		1	8.05	8.05	
B07-08	Muro de cerco - Eje: F - B	7	e= 0.15		1	12.17	12.17	
B06-09	Muro de cerco Eje: B - A	6	e= 0.15		1	15.02	15.02	
T1	Tareas Previas Eje: 7 y 2	Ventana alta	e= 0.25	1	8	6.00	48.00	
		Ventana alta	e= 0.25	1	8	6.80	54.40	
		Ventana Enro.	e= 0.15	1	8	7.40	59.20	
		Puerta Secc.	e= 0.15	1	8	8.60	68.80	
								315.34

PLAYA

PATIO DE GRAVA

INGRESO

COSTADO DE CASETA 1



LUDWIG CARRASCO BUSTAMANTE
 Ing. Supervisor - CIP 79040
 CESEL S.A.

PLANILLA DE METRADOS
ARQUITECTURA
TARRAJEO INTERIOR

	DESCRIPCIÓN		TARRAJEO			Protocolo	
	DESCRIPCIÓN DEL ELEMENTO	CANTIDAD	DIMENSIÓN (M)				TOTAL (M3)
	UBICACIÓN		L	A	H		
Feb-19	MUROS EJE H Y EJE P	2.00	44.82			186.02	
	MURO EJE 2	1.00	89.52				
	MURO EJE 7	1.00	51.68				

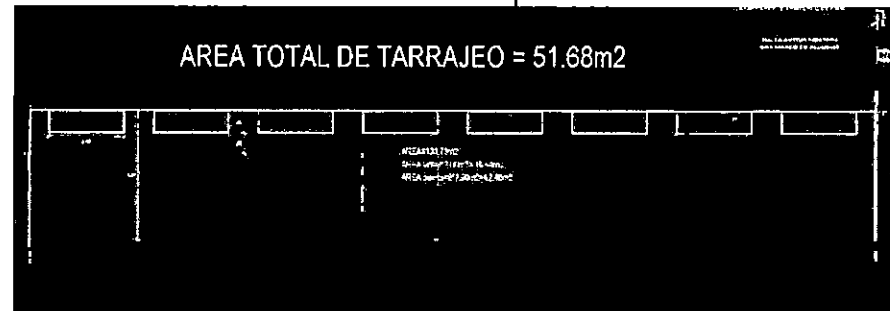

[Signature]
LUDWIG CAJASCO BUSTAMANTE
Ing. Supervisor - CIP 79040
OESEL S.A.

000001

CESEL INGENIEROS

CERTIFICADO EN: ISO 9001, ISO 14001, OHSAS 18001

Lima, 05 de marzo de 2019

CSL.174302.PU.DPA.S.320.19

Señores:

FONDO NACIONAL DE DESARROLLO PESQUERO - FONDEPES

Av. Petit Thouars N° 115 - Cercado de Lima

Lima.-

Atención : **Ing. Luis Alberto Barbieri Quino**

Director General de Inversión Pesquera Artesanal y Acuícola

Asunto : **Informe Mensual N°18 y Valorización N° 18 del Contratista CMN –
Febrero 2019**

Referencia : Contrato N° 30-2017- FONDEPES/OGA Supervisión de la Ejecución de la
Obra: "Mejoramiento y recuperación de los servicios del Desembarcadero
pesquero artesanal de Supe", Provincia de Barranca, Región de Lima.

a) C058-2019-CMN-SUPE (28-FEB-2019)

De mi consideración:

Es grato dirigimos a usted, para saludarlo y hacerle llegar el informe mensual N° 18 y la valorización N° 18 del contratista CMN entregada a la supervisión con el documento a) de la referencia, correspondiente al mes de febrero del 2019 de la Obra "Mejoramiento y recuperación de los servicios del Desembarcadero pesquero artesanal de Supe".

Agradeciendo la atención a la presente, nos despedimos.

Atentamente,

.....
LUDWING CARRASCO BUSTAMANTE
Ing. Supervisor - CIP 79040
CESEL S.A.

FONDO NACIONAL DE DESARROLLO PESQUERO	
	
2840842	
N° DOC:	00002094-2019
CLAVE:	0740
USUARIO:	usuario_alog69
FECHA Y HORA:	05/03/2019 17:03:00
TELEFONO:	2097700
www.fondepes.gob.pe	

Av. José Gálvez Barrenechea 646
San Isidro - Lima 27 - Perú
Telf: (51-1) 705-500
cesel@cesel.com.pe
www.cesel.com.pe



PERÚ

Ministerio de la Producción



FONDEPES

Fondo Nacional de Desarrollo Pesquero

Fecha: 06/03/19

MEMORANDO INTERNO N° 936 -2019-FONDEPES/DIGENIPAA/AOEM

Asunto : Memo Interno N° 1595-2019-DIGENIPAA

Referencia : _____ Registro: 2094

Destino	Indicación	Destino	Indicación

Observaciones: *Jug. Luis Tello*

Atentamente,



Indicaciones:

- | | | | |
|---------------------------|--------------------------|-----------------------------|--------------------------|
| 01. Autorizado/ Aprobado | 02. Calificar/ Evaluar | 03. Informe | 04. Proyectar resolución |
| 05. Atención/ Tramitación | 06. Conocimiento y fines | 07. Notificar al interesado | 08. Reformular |
| 09. Ayuda memoria | 10. Coordinar | 11. Opinión/ Recomend | 12. Consolidar |
| 13. Aclarar redacción | 14. Implementar/ Ejecut | 15. Preparar respuesta | 16. Visación |
| 17. Agregar a anteced | 18. Archivo | 19. Ampliar | 20. Seguimiento |



Fecha: 05/03/19

MEMORANDUM INTERNO N° 1595 -2019- FONDEPES/ DIGENIPAA

Asunto : CSL.174302.PU.OPA.S.320.19

Referencia : _____ Registro : 2094

Destino	Indicacion	Destino	Indicación
JEFATURA		DIGECADETA	
SG		OGA	
OCI		OGAJ	
DIGEPROFIN		OGPP	
DIGECADEPA		OTROS	ADEM

Observaciones: _____

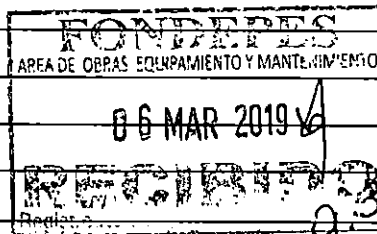
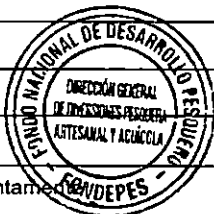

Atentamente

Indicaciones:

- | | | | |
|--------------------------------|--------------------------|-----------------------------|-----------------|
| 01. Autorizado/Aprobado | 02. Calificar/Evaluar | 03. Informe | 04. Proyectar |
| 05. Atención/Tramitación | 06. Conocimiento y fines | 07. Notificar al interesado | 08. Reformular |
| 09. Ayuda memoria | 10. Coordinar | 11. Opinión/Recomendación | 12. Consoliar |
| 13. Aclarar redacción | 14. Implementar/Ejecutar | 15. Preparar respuesta | 16. Visación |
| 17. Agregar a sus antecedentes | 18. Archivo | 19. Ampliar | 20. Seguimiento |

374

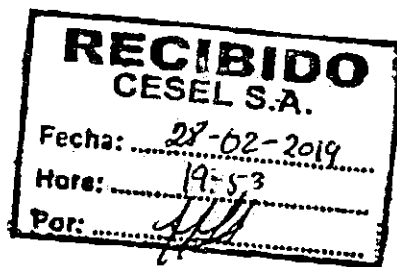

RECIBIDO, PERO NO DE CONFORMIDAD Y CMN, NO CONCLUIÓ METRANOS CON LA SUPERVISIÓN.

[Signature]
LUDWING CARRASCO EUSTAMANTE
Ing. Supervis. - CIP 79040
CESEL S.A.

C058-2019-CMN-SUPE

Supe, Febrero 28 del 2019

Señores
CESEL S.A.
Av. J. Gálvez Barrenechea N° 646 Urb. Corpac
San Isidro:

Atte : Ing. Ludwing Carrasco
Supervisión Cesel

Asunto: VALORIZACION E INFORME MENSUAL NRO 18 CORRESPONDIENTE AL MES DE FEBRERO 2019

Ref : MEJORAMIENTO Y RECUPERACION DE LOS SERVICIOS DEL DESEMBARCADERO PESQUERO ARTESANAL DE SUPE, DISTRITO DE SUPE PUERTO, PROVINCIA DE BARRANCA, REGIÓN LIMA

De nuestra consideración:

Es grato dirigimos a usted, para hacerles llegar adjunto a la presente, la valorización Nro 18 e informe mensual correspondiente al mes de Febrero del 2018.

Sin otro particular, quedamos de Uds:

Atentamente,

03 COPIAS
373 Folios

CONSORCIO MARITIMO DEL NORTE
DESEMBARCADERO ARTESANAL DE SUPE
[Signature]
DANIEL JOAQUIN MORALES VIVANCO
RESIDENTE DE OBRA
REG. CIP N° 98098

000373

VALORIZACIÓN N°18

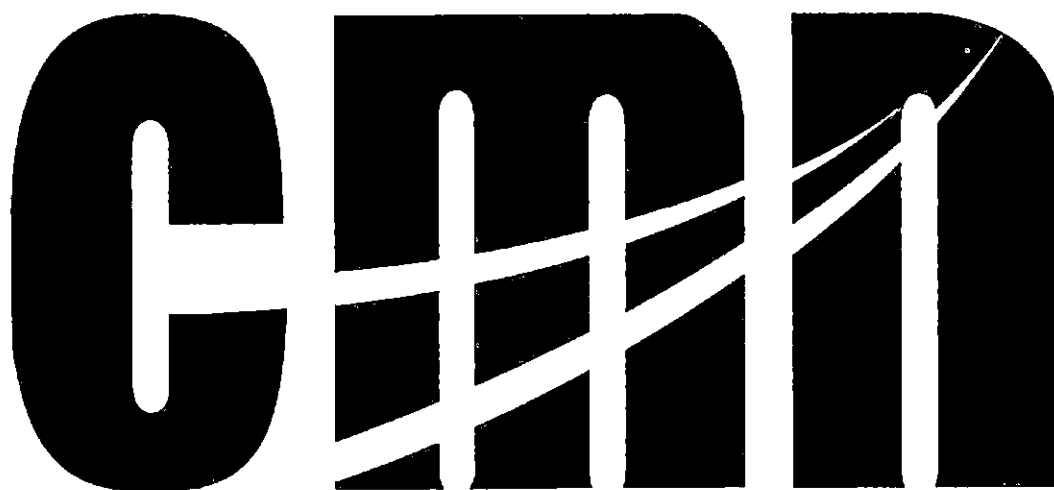

CONSORCIO MARITIMO DEL NORTE

**“Mejoramiento y Recuperación de los servicios del Desembarcadero
Pesquero Artesanal de Supe, Distrito de Supe Puerto, Provincia de
Barranca, Región Lima”**

FEBRERO

2019

CONSORCIO MARITIMO DEL NORTE
DESEMBARCADERO ARTESANAL DE SUPE
DANIEL JOAQUIN MORALES VIVA N°60
RESIDENTE DE OBRA
REG. CIP N° 98098



CONSORCIO MARÍTIMO DEL NORTE

MEJORAMIENTO Y RECUPERACION DE LOS SERVICIOS DEL
DESEMBARCADERO PESQUERO ARTESANAL DE SUPE, DISTRITO DE SUPE
PUERTO, PROVINCIA DE BARRANCA, REGIÓN LIMA

Tipo de Documento	N°	Mes	Fecha
Valorización	18	Febrero	28/02/2019

0003.2

VALORIZACIÓN N°18

- I. RESUMEN: VALORIZACIÓN N°18
- II. ANEXO N°1: OBRAS PORTUARIAS
- III. ANEXO N°2: ESTRUCTURAS EN TIERRA
- IV. ANEXO N°3: ARQUITECTURA
- V. ANEXO N°4: INSTALACIONES SANITARIAS
- VI. ANEXO N°4: COPIA DE RESOLUCIONES

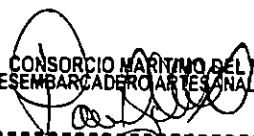
CONSORCIO MARITIMO DEL NORTE
DESEMBARCADERO ARTESANAL DE SUPE

DANIEL JOAQUÍN MORALES VIVANCO
RESIDENTE DE OBRA
REG. CIP N° 98098



CONSORCIO MARÍTIMO DEL NORTE

MEJORAMIENTO Y RECUPERACION DE LOS SERVICIOS DEL
DESEMBARCADERO PESQUERO ARTESANAL DE SUPE, DISTRITO DE SUPE
PUERTO, PROVINCIA DE BARRANCA, REGIÓN LIMA

Tipo de Documento	N°	Mes	Fecha
Valorización	18	Febrero	28/02/2019

000371

RESUMEN VALORIZACIÓN N°18



FEBRERO

2018

CONSORCIO MARITIMO DEL NORTE
DESEMBARCADERO ARTESANAL DE SUPE

DANIEL JOAQUÍN MORALES VIVANCO
RESIDENTE DE OBRA
REG. CIP N° 98098

000370



Hoja de Cálculo

RESUMEN DE VALORIZACIÓN N°18 DEL 01 AL 28 DE FEBRERO DE 2019



CESEL INGENIEROS

Obra	"Mejoramiento Integral del Desembarcadero Pesquero Artesanal de Supe"	Plazo	270 días
Contratista	Consortio Marítimo del Norte	Inicio	19 febrero 2017
Precios	via 17 mar 2017	Fin	15 de junio 2018
		Supervisión	CESEL E. A.
		Monto Inv. ICV	S/21,508,989.81

	CONTRATO	ACUMULADO ANTERIOR	MONTO MENSUAL	ACUMULADO ACTUAL	% DE AVANCE	SALDO
A	MONTOS CONTRACTUALES (V) - Sin I.G.V.					
	Presupuesto Expediente Técnico (Sin I.G.V.)	S/19,228,043.63	S/8,284,877.62	S/545,843.79	S/8,830,421.41	S/9,397,622.22
	Presupuesto Obras Portuarias	S/8,897,118.06	S/3,307,636.88	S/442,879.08	3,750,516.06	S/6,146,602.00
	Presupuesto Edificación en Tierra - Estructura	S/3,081,408.51	S/2,834,424.52	S/3,906.12	2,868,330.64	S/623,077.86
	Presupuesto Edificación en Tierra - Arquitectura	S/1,738,221.23	S/574,331.18	S/68,016.74	642,347.91	S/1,095,873.32
	Presupuesto Edificación en Tierra - Instalaciones Eléctricas	S/853,003.57	S/25,414.48	S/0.00	35,414.48	S/617,589.09
	Presupuesto Edificación en Tierra - Instalaciones Sanitarias	S/820,830.60	S/115,857.52	S/941.86	116,799.38	S/704,131.22
	Presupuesto Edificación en Tierra - Equipamiento	S/2,373,404.09	1378948.60	S/0.00	1,378,948.60	S/994,455.45
	Presupuesto Impacto Ambiental	S/63,957.61	S/38,064.34	S/0.00	38,064.34	S/15,893.28
	SUB TOTAL PRESUPUESTO	S/19,228,043.63	S/8,284,877.62	S/545,843.79	S/8,830,421.41	S/9,397,622.22
	I.G.V.	S/3,281,047.85	S/1,491,223.97	S/68,251.88	S/1,589,476.65	S/1,691,672.00
	PRESUPUESTO TOTAL Con I.G.V.	S/21,509,091.48	S/9,776,101.59	S/614,095.67	S/10,419,898.06	S/11,089,294.22
B	REAJUSTES y REGULARIZACION REAJUSTES (S) - Sin I.G.V.					
	Reajuste Fórmula Polinómica Val. 17 - Indices Diciembre 2018 Obras Portuarias		S/91,372.66	S/37,795.89	S/129,168.67	
	Reajuste Fórmula Polinómica Val. 17 - Indices Diciembre 2018 Estructuras		S/76,151.75	S/148.32	S/76,300.07	
	Reajuste Fórmula Polinómica Val. 17 - Indices Diciembre 2018 Arquitectura		S/93,417.37	S/5,106.36	S/42,623.72	
	Reajuste Fórmula Polinómica Val. 17 - Indices Diciembre 2018 Eléctricas		-S/21,937.84	S/0.00	-S/21,937.84	
	Reajuste Fórmula Polinómica Val. 17 - Indices Diciembre 2018 Sanitarias		S/20,140.45	S/167.74	S/20,308.19	
	Reajuste Fórmula Polinómica Val. 17 - Indices Diciembre 2018 Equipamiento		S/29,404.78	S/0.00	S/29,404.78	
	Reajuste Fórmula Polinómica Val. 17 - Indices Diciembre 2018 Impacto Ambiental		S/442.34	S/0.00	S/442.34	
	TOTAL REAJUSTES		S/232,991.52	S/43,218.30	S/276,209.82	
C	VALORIZACION BRUTA (VB = V+S)					
		S/8,517,569.14	S/589,062.09	S/9,106,631.23		
D	DEDUCCIONES (D) - Sin I.G.V.					
	Deducciones del Adelanto Directo					
	Deducciones del Adelanto Directo Obras Portuarias		S/2,437.80	S/3,432.97	587.17	
	Deducciones del Adelanto Directo Edif. en Tierra Estructuras		S/6,447.30	S/211.44	5663.74	
	Deducciones del Adelanto Directo Edif. en Tierra Arquitectura		S/9,029.81	S/451.28	3479.10	
	Deducciones del Adelanto Directo Edif. en Tierra Instalaciones Eléctricas		-S/242.97	S/0.00	-242.97	
	Deducciones del Adelanto Directo Edif. en Tierra Instalaciones Sanitarias		S/2,309.67	S/20.04	2289.71	
	Deducciones del Adelanto Directo Edif. en Tierra Equipamiento		S/4,101.78	S/0.00	4101.78	
	Deducciones del Adelanto Directo Impacto Ambiental		S/1.04	S/0.00	1.04	
	Deducciones del Adelanto de Materiales					
	Deducciones del Adelanto de materiales Obras Portuarias		S/11,596.42	S/19,126.45	S/30,722.87	
	Deducciones del Adelanto de materiales Edif. en Tierra Estructuras		S/37,167.88	S/1,039.69	S/38,207.57	
	Deducciones del Adelanto de materiales Edif. en Tierra Arquitectura		S/2,755.52	S/502.34	S/3,257.86	
	Deducciones del Adelanto de materiales Edif. en Tierra Instalaciones Eléctricas		S/0.00	S/0.00	S/0.00	
	Deducciones del Adelanto de materiales Edif. en Tierra Instalaciones Sanitarias		S/0.00	S/0.00	S/0.00	
	Deducciones del Adelanto de materiales Edif. en Tierra Equipamiento		S/0.00	S/0.00	S/0.00	
	Deducciones del Adelanto de materiales Impacto Ambiental		S/0.00	S/0.00	S/0.00	
	TOTAL DEDUCCIONES		68,604.27	24,794.22	93,398.49	
E	AMORTIZACIONES (A)					
	Amortización de Adelanto Directo (12.40%)	1,822,804.37	891,033.78	67,884.63	958,918.41	
	Amortización del Adelanto Directo Obras Portuarias	889,711.81	S/341,718.22	S/64,929.41	396847.63	
	Amortización del Adelanto Directo Edif. en Tierra Estructuras	369,140.85	S/305,630.78	S/4,204.36	309935.14	
	Amortización del Adelanto Directo Edif. en Tierra Arquitectura	173,822.12	S/66,810.79	S/8,434.08	75244.86	
	Amortización del Adelanto Directo Edif. en Tierra Instalaciones Eléctricas	65,300.36	S/4,117.75	S/0.00	4117.75	
	Amortización del Adelanto Directo Edif. en Tierra Instalaciones Sanitarias	82,093.06	S/13,761.94	S/116.72	13878.73	
	Amortización del Adelanto Directo Edif. en Tierra Equipamiento	237,340.41	S/154,993.82	S/0.00	164993.82	
	Amortización del Adelanto Directo Impacto Ambiental	5,395.76	S/4,000.49	S/0.00	4000.49	
	Amortización de Adelanto de materiales					
	Amortización del Adelanto de Materiales Obras Portuarias N°01	1,000,000.00	1,785,165.88	197,896.57	1,983,062.56	
	Amortización del Adelanto de Materiales Obras Portuarias N°02		S/764,067.67	S/0.00	764,067.67	
	Amortización del Adelanto de Materiales Obras Portuarias N°03		S/285,717.62	S/178,094.30	463,811.92	
	Amortización del Adelanto de Materiales Edif. en Tierra Estructuras N°01		S/208,766.47	S/0.00	208,766.47	
	Amortización del Adelanto de Materiales Edif. en Tierra Estructuras N°02		S/126,915.18	S/0.00	126,915.18	
	Amortización del Adelanto de Materiales Edif. en Tierra Estructuras N°03		S/344,930.09	S/13,853.73	358,783.82	
	Amortización del Adelanto de Materiales Edif. en Tierra Arquitectura N°01		S/20,889.64	S/1,447.94	22,337.58	
	Amortización del Adelanto de Materiales Edif. en Tierra Arquitectura N°02		S/0.00	S/0.00	0.00	
	Amortización del Adelanto de Materiales Edif. en Tierra Arquitectura N°03		S/34,878.42	S/4,600.60	39,479.02	
	Amortización del Adelanto de Materiales Edif. en Tierra Instalaciones Eléctricas		S/0.00	S/0.00	0.00	
	Amortización del Adelanto de Materiales Edif. en Tierra Instalaciones Sanitarias		S/0.00	S/0.00	0.00	
	Amortización del Adelanto de Materiales Edif. en Tierra Equipamiento		S/0.00	S/0.00	0.00	
	Amortización del Adelanto de Materiales Impacto Ambiental		S/0.00	S/0.00	0.00	
	TOTAL AMORTIZACIONES		2,677,219.77	265,581.20	2,942,800.97	
F	VALORIZACION NETA (VN = VB-D-A)					
		5,771,745.11	298,686.66	6,070,431.77		
G	MONTOS A PAGAR AL CONTRATISTA					
	En Efectivo (VN)	5,771,745.11	298,686.66	6,070,431.77		
	I.G.V. (=VN x 18%)	1,038,914.12	53,763.80	1,092,677.92		
H	MONTO TOTAL DE LA VALORIZACION CON I.G.V. EN NUEVOS SOLES					
		6,810,659.23	352,450.26	7,163,109.60		
I	CALENDARIO DE COMPROMISO A SOLICITAR EN NUEVOS SOLES					
			352,450.26			

CONSORCIO MARITIMO DEL NORTE
 DESEMBARCADERO ARTESANAL DE SUPE
 DANIEL JOAQUIN MORALES VIVANCO
 RESIDENTE DE OBRA
 REG. CIP N° 98098



Hoja de Cálculo

RESUMEN DE VALORIZACIÓN N°17 DEL 01 AL 31 DE ENERO DE 2019



Obra	"Mejoramiento Integral del Desembarcadero Pesquero Artesanal de Supe"	Plazo	300 días
		Inicio	19 setiembre 2017
		Fin	15 de julio 2018
Contratista	Consorcio Marítimo del Norte	Supervisión	CESEL S.A.
Precios	vie 17 Mar 2017	Monto IGV	S/21,509,089.81

A	MONTOS CONTRACTUALES (V) - Sin I.G.V.	Contrato	ACUMULADO MES ANTERIOR		MES ACTUAL		AVANCE ACUMULADO ACTUAL		SALDO
			Monto Acumulado Anterior	% de Avance	Monto Mensual	% de Avance	Monto Acumulado Actual	% de Avance	
	Presupuesto Obras Portuarias	S/8,897,118.06	S/3,275,988.88	36.82%	S/442,979.08	4.98%	S/3,750,516.04	42.15%	S/5,146,602.01
	Presupuesto Edificación en Tierra - Estructura	S/3,691,408.51	S/2,801,688.88	75.90%	S/33,906.12	0.92%	S/2,868,330.63	77.70%	S/823,077.87
	Presupuesto Edificación en Tierra - Arquitectura	S/1,738,221.23	S/476,922.76	27.44%	S/68,016.74	3.91%	S/642,347.90	36.95%	S/1,095,873.33
	Presupuesto Edificación en Tierra - Instalaciones Electricas	S/653,003.57	S/32,650.19	5.00%	S/0.00	0.00%	S/35,414.46	5.42%	S/617,589.09
	Presupuesto Edificación en Tierra - Instalaciones Sanitarias	S/820,930.60	S/106,332.75	12.95%	S/941.86	0.11%	S/116,799.38	14.23%	S/704,131.22
	Presupuesto Edificación en Tierra - Equipamiento	S/2,373,404.06	S/1,378,948.60	58.10%	S/0.00	0.00%	S/1,378,948.60	58.10%	S/994,455.45
	Presupuesto Impacto Ambiental	S/53,957.61	S/38,034.52	70.49%	S/0.00	0.00%	S/38,064.34	70.54%	S/15,893.28
	SUB TOTAL PRESUPUESTO	S/18,228,043.63	S/8,110,662.68		S/645,843.79		S/8,630,421.38		S/8,397,622.26
	I.G.V.	S/3,281,047.85	S/1,459,901.26		S/98,251.88		S/1,589,475.84		S/1,691,572.01
	PRESUPUESTO TOTAL con IGV	S/21,609,091.48	S/9,670,463.84	44.49%	S/644,095.67	2.99%	S/10,419,897.22	48.44%	S/11,089,194.27

CONSORCIO MARITIMO DEL NORTE
DESEMBARCADERO ARTESANAL DE SUPE

DANIEL JOAQUIN MORALES VIVA VCO
RESIDENTE DE OBRA
REG. CIP N° 98098

000366

000368



Contrato N° 025-2017- FONDEPES Ejecución de la
Obra: MEJORAMIENTO DE LOS SERVICIOS DEL
DESEMBARCADERO PESQUERO ARTESANAL DE
SUPE, REGION LIMA, PROVINCIA DE BARRANCA,
DISTRITO DE SUPE PUERTO



RESUMEN

VALORIZACIÓN N° 18 DEL 01 AL 28 DE FEBRERO DE 2019

OBRA: MEJORAMIENTO DE LOS SERVICIOS DEL DESEMBARCADERO PESQUERO ARTESANAL DE SUPE ,REGION LIMA, PROVINCIA DE BARRANCA, DISTRITO DE SUPE PUERTO
PROP: FONDEPES
CONTRAT: CONSORCIO MARITIMO DEL NORTE
SERV: CESEL
mlé 27 feb 2019

CONCEPTOS		VALORIZACION ACTUAL	VALORIZACION ACUMULADA ANTERIOR	VALORIZACION ACUMULADA ACTUAL
1.1	MONTO VALORIZADO	545,843.79	8,284,577.62	8,830,421.41
1.2	REAJUSTE DE VALORIZACIÓN	43,218.30	232,991.52	276,209.82
A.	TOTAL VALORIZACION REAJUSTADA	589,062.09	8,517,569.14	9,106,631.23
2.0	AMORTIZACIONES			
2.1	ADELANTO DIRECTO (12.40%)	67,684.63	869,455.92	937,140.55
2.2	ADELANTO DE MATERIALES	197,896.57	1,753,429.11	1,951,325.68
B.	TOTAL AMORTIZACIONES	265,581.20	2,622,885.03	2,888,466.23
3.0	DEDUCCIONES			
3.1	POR EL ADELANTO DIRECTO	4,125.74	15,706.29	19,832.03
3.3	POR EL ADELANTO POR MATERIALES	20,668.48	48,314.11	68,982.59
C.	TOTAL DEDUCCIONES	24,794.22	64,020.40	88,814.62
4.0	IGV 18% DE (A-B-C)	53,763.60	1,049,519.47	1,103,283.07
5.0	LIQUIDO A PAGAR AL CONTRATISTA (A-B-C+IGV)	352,450.26	6,880,183.19	7,232,633.46
	A FAVOR DEL CONTRATISTA	298,686.66	5,830,663.72	6,129,350.39
	POR CONCEPTO DE I.G.V	53,763.60	1,049,519.47	1,103,283.07

CONSORCIO MARITIMO DEL NORTE
DESEMBARCADERO ARTESANAL DE SUPE

DANIEL JOAQUÍN MORALES VIVA NCO
RESIDENTE DE OBRA
REG. CIP N° 98098



Contrato N° 025-2017- FONDEPES Ejecucion de la Obra:
MEJORAMIENTO DE LOS SERVICIOS DEL DESEMBARCADERO
PESQUERO ARTESANAL DE SUPE, REGION LIMA, PROVINCIA
DE BARRANCA, DISTRITO DE SUPE PUERTO



RESUMEN

VALORIZACIÓN N° 18 DEL 01 AL 28 DE FEBRERO DE 2019

000307

OBRA: MEJORAMIENTO DE LOS SERVICIOS DEL DESEMBARCADERO PESQUERO ARTESANAL DE SUPE ,REGION LIMA, PROVINCIA DE BARRANCA, DISTRITO DE SUPE
PROP: FONDEPES
CONTRAT: CONSORCIO MARITIMO DEL NORTE
SUPERV: CESEL

CONCEPTOS	VALORIZACION ACTUAL	VALORIZACION ACUMULADA ANTERIOR	VALORIZACION ACUMULADA ACTUAL
1.1 MONTO VAL. OBRAS PORTUARIAS	442,979.08	3,307,536.98	3,750,516.06
1.2 REAJUSTE DE VAL. OBRAS PORTUARIAS	37,795.89	91,372.68	129,168.57
2.1 MONTO VAL. EDIFICIO EN TIERRA ESTRUCTURA	33,906.12	2,834,424.52	2,868,330.64
2.2 REAJUSTE DE VAL. EDIFICIO EN TIERRA ESTRUCTURA	148.32	76,151.75	76,300.07
3.1 MONTO VAL. EDIFICIO EN TIERRA ARQUITECTURA	68,016.74	574,331.18	642,347.91
3.2 REAJUSTE DE VAL. EDIFICIO EN TIERRA ARQUITECTURA	5,106.36	37,417.37	42,523.72
4.1 MONTO VAL. EDIF. EN TIERRA INSTALACIONES ELECTRICAS	-	35,414.48	35,414.48
4.2 REAJUSTE DE VAL. EDIF. EN TIERRA INSTALACIONES ELECTRICAS	-	-21,937.84	-21,937.84
5.1 MONTO VAL. EDIF. EN TIERRA INSTALACIONES SANITARIAS	941.86	115,857.52	116,799.38
5.2 REAJUSTE DE VAL. EDIF. EN TIERRA INSTALACIONES SANITARIAS	167.74	20,140.45	20,308.19
6.1 MONTO VAL. EDIFICIO EN TIERRA EQUIPAMIENTO	-	1,378,948.60	1,378,948.60
6.2 REAJUSTE DE VAL. EDIFICIO EN TIERRA EQUIPAMIENTO	-	29,404.78	29,404.78
7.1 MONTO VAL. IMPACTO AMBIENTAL	-	38,064.34	38,064.34
7.2 REAJUSTE DE VAL. IMPACTO AMBIENTAL	-	442.34	442.34
A. TOTAL VALORIZACION REAJUSTADA	589,062.09	8,517,569.15	9,106,631.23
2.0 AMORTIZACIONES			
2.0 OBRAS PORTUARIAS			
2.1 ADELANTO DIRECTO	54,929.41	341,718.22	396,647.63
2.2 ADELANTO DE MATERIALES N°01	-	764,067.67	764,067.67
2.3 ADELANTO DE MATERIALES N°02	178,094.30	285,717.52	463,811.82
2.4 ADELANTO DE MATERIALES N°03	-	-	-
2 EDIFICIO EN TIERRA ESTRUCTURA			
2.1 ADELANTO DIRECTO	4,204.36	305,630.78	309,835.14
2.2 ADELANTO DE MATERIALES N°01	-	208,786.47	208,786.47
2.3 ADELANTO DE MATERIALES N°02	13,853.73	471,845.27	485,699.00
2.4 ADELANTO DE MATERIALES N°03	1,447.94	20,889.64	22,337.58
2 EDIFICIO EN TIERRA ARQUITECTURA			
2.1 ADELANTO DIRECTO	8,434.08	66,810.79	75,244.86
2.2 ADELANTO DE MATERIALES N°01	-	-	-
2.3 ADELANTO DE MATERIALES N°02	4,500.60	34,879.42	39,380.02
2.4 ADELANTO DE MATERIALES N°03	-	-	-
2 EDIF. EN TIERRA INSTALACIONES ELECTRICAS			
2.1 ADELANTO DIRECTO	-	4,117.75	4,117.75
2.2 ADELANTO DE MATERIALES	-	-	-
2 EDIF. EN TIERRA INSTALACIONES SANITARIAS			
2.1 ADELANTO DIRECTO	116.79	13,761.94	13,878.73
2.2 ADELANTO DE MATERIALES	-	-	-
2 EDIFICIO EN TIERRA EQUIPAMIENTO			

CONSORCIO MARITIMO DEL NORTE
DESEMBARCADERO ARTESANAL DE SUPE
DANIEL JOAQUIN MORALES VIVA NCO
RESIDENTE DE OBRA
REG. CIP N° 98098



Contrato N° 025-2017- FONDEPES Ejecución de la Obra:
MEJORAMIENTO DE LOS SERVICIOS DEL DESEMBARCADERO
PESQUERO ARTESANAL DE SUPE, REGION LIMA, PROVINCIA
DE BARRANCA, DISTRITO DE SUPE PUERTO



RESUMEN

VALORIZACIÓN N° 18 DEL 01 AL 28 DE FEBRERO DE 2019

000006

OBRA: MEJORAMIENTO DE LOS SERVICIOS DEL DESEMBARCADERO PESQUERO ARTESANAL DE SUPE, REGION LIMA, PROVINCIA DE BARRANCA, DISTRITO DE SUPE
PROP: FONDEPES
CONTRAT: CONSORCIO MARITIMO DEL NORTE
SUPERV: CESEL

CONCEPTOS	VALORIZACION ACTUAL	VALORIZACION ACUMULADA ANTERIOR	VALORIZACION ACUMULADA ACTUAL
2.1 ADELANTO DIRECTO	-	154,993.82	154,993.82
2.2 ADELANTO DE MATERIALES	-	-	-
2 IMPACTO AMBIENTAL			
2.1 ADELANTO DIRECTO	-	4,000.49	4,000.49
2.2 ADELANTO DE MATERIALES	-	-	-
B. TOTAL AMORTIZACIONES	265,581.20	2,677,219.76	2,942,800.97
3.0 DEDUCCIONES			
2.0 OBRAS PORTUARIAS			
3.1 POR EL ADELANTO DIRECTO	3,432.97	2,437.80	5,870.77
3.3 POR EL ADELANTO POR MATERIALES	19,126.45	11,596.42	30,722.87
2 EDIFICIO EN TIERRA ESTRUCTURA			
3.1 POR EL ADELANTO DIRECTO	211.44	5,447.30	5,658.74
3.3 POR EL ADELANTO POR MATERIALES	1,039.69	37,167.88	38,207.57
2 EDIFICIO EN TIERRA ARQUITECTURA			
3.1 POR EL ADELANTO DIRECTO	461.29	3,029.81	3,491.10
3.3 POR EL ADELANTO POR MATERIALES	502.34	2,755.52	3,257.86
2 EDIF. EN TIERRA INSTALACIONES ELECTRICAS			
3.1 POR EL ADELANTO DIRECTO	-	-242.97	-242.97
3.3 POR EL ADELANTO POR MATERIALES	-	-	-
2 EDIF. EN TIERRA INSTALACIONES SANITARIAS			
3.1 POR EL ADELANTO DIRECTO	20.04	2,309.67	2,329.71
3.3 POR EL ADELANTO POR MATERIALES	-	-	-
2 EDIFICIO EN TIERRA EQUIPAMIENTO			
3.1 POR EL ADELANTO DIRECTO	-	4,101.79	4,101.79
3.3 POR EL ADELANTO POR MATERIALES	-	-	-
2 IMPACTO AMBIENTAL			
3.1 POR EL ADELANTO DIRECTO	-	1.04	1.04
3.3 POR EL ADELANTO POR MATERIALES	-	-	-
C. TOTAL DEDUCCIONES	24,794.22	68,604.27	93,398.49
4.0 IGV 18% DE (A-B-C)	53,763.60	1,038,914.12	1,092,677.72
5.0 LIQUIDO A PAGAR AL CONTRATISTA (A-B-C+IGV)	352,450.26	6,810,659.24	7,163,109.50
A FAVOR DEL CONTRATISTA	298,686.66	5,771,745.12	6,070,431.78
POR CONCEPTO DE I.G.V	53,763.60		53,763.60

CONSORCIO MARITIMO DEL NORTE
DESEMBARCADERO ARTESANAL DE SUPE
DANIEL JOAQUIN MORALES VIVAYCO
RESIDENTE DE OBRA
REG. CIP N° 98098



VALORIZACIÓN N° 18 DEL 01 AL 28 DE FEBRERO DE 2019 (PRECIOS UNITARIOS)

Contrato N° 025-2017- FONDEPES Ejecución de la Obra: MEJORAMIENTO DE LOS SERVICIOS DEL DESEMBARCADERO PESQUERO ARTESANAL DE SUPE, REGION LIMA, PROVINCIA DE BARRANCA, DISTRITO DE SUPE PUERTO



OBRA: MEJORAMIENTO DE LOS SERVICIOS DEL DESEMBARCADERO PESQUERO ARTESANAL DE SUPE, REGION LIMA, PROVINCIA DE BARRANCA, DISTRITO DE SUPE PUERTO
 SUB PRES OBRAS PORTUARIAS
 PROP. FONDEPES
 CONT. CONSORCIO MARITIMO DEL NORTE
 SUP. CESEL

FECHA: mlé 27 Feb 2019

ITEM	DESCRIPCION	PRESUPUESTO			VAL. ACUM. ANTERIOR			VAL. ACTUAL			VAL. ACUM. ACTUAL			SALDOS			
		Und.	Metrado	Precio (S/.)	Parcial (S/.)	Metrado	Parcial (S/.)	%	Metrado	Parcial (S/.)	%	Metrado	Parcial (S/.)	%	Metrado	Parcial (S/.)	%
01	OBRAS PORTUARIAS																
01.01	OBRAS PROVISIONALES																
01.01.01	MOVILIZACION Y DESMOVILIZACION DE EQUIPOS	pb	1.00	42,963.69	42,963.69	1.00	42,963.69	100.00%	0.00	0.00	0.00%	1.00	42,963.69	100.00%	0.0000	0.00	0.00%
01.01.02	FLETE TERRESTRE DE MATERIALES	tm	3,056.63	85.92	262,625.65	3,056.63	262,625.65	100.00%	0.00	0.00	0.00%	3,056.63	262,625.65	100.00%	0.0000	0.00	0.00%
01.01.03	TRAZO Y REPLANTEO DE OBRA	mes	9.00	2,287.15	20,584.35	9.00	20,584.35	100.00%	0.00	0.00	0.00%	9.00	20,584.35	100.00%	0.0000	0.00	0.00%
01.01.04	AGUA PARA OBRA	mes	9.00	297.14	2,674.26	9.00	2,674.26	100.00%	0.00	0.00	0.00%	9.00	2,674.26	100.00%	0.0000	0.00	0.00%
01.01.05	ENERGIA PARA OBRA	mes	9.00	1,452.65	13,073.85	9.00	13,073.85	100.00%	0.00	0.00	0.00%	9.00	13,073.85	100.00%	0.0000	0.00	0.00%
01.01.06	CARTEL DE OBRA	und	2.00	2,767.23	5,534.46	2.00	5,534.46	100.00%	0.00	0.00	0.00%	2.00	5,534.46	100.00%	0.0000	0.00	0.00%
01.01.07	LOSAS PARA PREFABRICADOS (Concreto f'c=210 kg/cm2)	m2	240.00	141.92	34,060.80	240.00	34,060.80	100.00%	0.00	0.00	0.00%	240.00	34,060.80	100.00%	0.0000	0.00	0.00%
01.01.08	LIMPIEZA FINAL DE OBRA	pb	1.00	3,448.35	3,448.35	0.00	0.00	0.00%	0.00	0.00	0.00%	0.00	0.00	0.00%	1.0000	3,448.35	100.00%
01.01.09	CASETA PARA CONTRATISTA Y SUPERVISIÓN	m2	120.00	182.41	21,889.20	120.00	21,889.20	100.00%	0.00	0.00	0.00%	120.00	21,889.20	100.00%	0.0000	0.00	0.00%
01.01.10	PRUEBA DE CARGA	und	4.00	16,884.27	67,537.08	1.00	16,884.27	25.00%	0.00	0.00	0.00%	1.00	16,884.27	25.00%	3.0000	50,652.81	75.00%
01.01.11	DEMOLICIÓN DE LOSAS Y VIGAS (PUENTE Y CABEZO)	m3	291.45	381.67	111,237.72	18.47	7,049.44	6.34%	0.00	0.00	0.00%	18.47	7,049.44	6.34%	272.9800	104,188.28	93.66%
01.01.12	ALMACEN DE OBRA	m2	120.00	182.41	21,889.20	120.00	21,889.20	100.00%	0.00	0.00	0.00%	120.00	21,889.20	100.00%	0.0000	0.00	0.00%
01.01.13	EQUIPOS E IMPLEMENTOS DE SEGURIDAD	und	3.00	17,918.25	53,754.75	2.00	35,836.50	66.67%	0.00	0.00	0.00%	2.00	35,836.50	66.67%	1.0000	17,918.25	33.33%
01.02	MUELLE TIPO ESPIGÓN																
01.02.01	FABRICACIÓN DE PILOTOS DE CONCRETO																
01.02.01.01	CONCRETO EN PILOTOS Fc=350 kg/cm2	m3	576.32	552.49	318,411.04	400.37	221,200.42	69.47%	175.95	97,210.62	30.53%	576.32	318,411.04	100.00%	0.0000	0.00	0.00%
01.02.01.02	ENCOFRADO Y DESENCOFRADO	m2	4,610.52	44.69	206,044.14	2,508.70	112,113.80	54.41%	2,101.82	93,930.34	45.59%	4,610.52	206,044.14	100.00%	0.0000	0.00	0.00%
01.02.01.03	ACERO CORRUGADO FY= 4200 kg/cm2	kg	181,053.38	4.20	760,424.20	149,289.07	627,014.09	62.46%	31,764.31	133,410.10	17.54%	181,053.38	760,424.20	100.00%	0.0000	0.00	0.00%
01.02.02	FABRICACIÓN DE VIGAS TRANSVERSALES																
01.02.02.01	CONCRETO VIGAS TRANSVERSALES Fc=280 kg/cm2	m3	132.45	520.19	68,899.17	130.38	67,822.37	98.44%	0.00	0.00	0.00%	130.38	67,822.37	98.44%	2.0700	1,076.80	1.56%
01.02.02.02	ENCOFRADO Y DESENCOFRADO DE VIGAS TRANSVERSALES	m2	1,005.66	55.45	55,761.85	944.68	52,382.51	93.93%	0.00	0.00	0.00%	944.68	52,382.51	93.93%	60.9800	3,381.34	6.06%
01.02.02.03	ACERO CORRUGADO VIGAS TRANSVERSALES FY= 4200 kg/cm2	kg	33,940.52	4.52	153,411.15	33,940.52	153,411.15	100.00%	0.00	0.00	0.00%	33,940.52	153,411.15	100.00%	0.0000	0.00	0.00%
01.02.03	FABRICACIÓN DE LOSAS NERVADAS EN MUELLE																
01.02.03.01	CONCRETO LOSAS NERVADAS Fc= 280 kg/cm2	m3	201.46	438.44	88,328.12	189.76	83,198.37	94.19%	0.00	0.00	0.00%	189.76	83,198.37	94.19%	11.7000	5,129.75	5.81%
01.02.03.02	ENCOFRADO Y DESENCOFRADO LOSAS NERVADAS	m2	1,176.31	50.07	58,897.84	1,044.38	52,292.11	88.78%	0.00	0.00	0.00%	1,044.38	52,292.11	88.78%	131.9300	6,605.73	11.22%
01.02.03.03	ACERO CORRUGADO LOSAS NERVADAS FY= 4200 kg/cm2	kg	50,952.59	4.20	214,000.88	50,952.59	214,000.88	100.00%	0.00	0.00	0.00%	50,952.59	214,000.88	100.00%	0.0000	0.00	0.00%
01.02.04	NUCLEOS LLENADOS EN SITU																
01.02.04.01	CONCRETO EN NÚCLEOS Fc=280 kg/cm2	m3	149.11	465.68	69,437.54		0.00	0.00%	0.00	0.00	0.00%		0.00	0.00%	149.1100	69,437.54	100.00%
01.02.04.02	ENCOFRADO Y DESENCOFRADO NÚCLEOS	m2	290.85	50.07	14,562.86		0.00	0.00%	0.00	0.00	0.00%		0.00	0.00%	290.8500	14,562.86	100.00%
01.02.04.03	ACERO CORRUGADO NÚCLEOS FY= 4200 kg/cm2	kg	15,991.25	4.20	67,163.25		0.00	0.00%	0.00	0.00	0.00%		0.00	0.00%	15,991.2500	67,163.25	100.00%
01.02.05	JUNTAS LONGITUDINALES Y TRANSVERSALES																
01.02.05.01	CONCRETO EN JUNTAS LONGITUDINALES Y TRANSVERSALES	m3	45.43	465.68	21,155.84		0.00	0.00%	0.00	0.00	0.00%		0.00	0.00%	45.4300	21,155.84	100.00%
01.02.05.02	ENCOFRADO Y DESENCOFRADO EN JUNTAS LONGITUDINALES Y	m2	85.14	50.07	4,262.96		0.00	0.00%	0.00	0.00	0.00%		0.00	0.00%	85.1400	4,262.96	100.00%
01.02.05.03	ACERO CORRUGADO JUNTAS LONG Y TRANSV FY= 4200 kg/cm2	kg	1,956.86	4.20	8,218.81		0.00	0.00%	0.00	0.00	0.00%		0.00	0.00%	1,956.8600	8,218.81	100.00%
01.02.06	SARDINEL LLENADO EN SITU																
01.02.06.01	CONCRETO EN SARDINEL Fc=280 kg/cm2.	m3	18.29	460.20	8,417.06		0.00	0.00%	0.00	0.00	0.00%		0.00	0.00%	18.2900	8,417.06	100.00%
01.02.06.02	ENCOFRADO Y DESENCOFRADO SARDINELES	m2	162.61	44.69	7,267.04		0.00	0.00%	0.00	0.00	0.00%		0.00	0.00%	162.6100	7,267.04	100.00%
01.02.06.03	ACERO CORRUGADO SARDINELES FY= 4200 kg/cm2	kg	3,979.02	4.20	16,711.88		0.00	0.00%	0.00	0.00	0.00%		0.00	0.00%	3,979.0200	16,711.88	100.00%
01.02.07	LOSAS VACIADAS EN SITU																
01.02.07.01	CONCRETO LOSAS IN SITU Fc=280 kg/cm2	m3	170.74	465.68	79,510.20		0.00	0.00%	0.00	0.00	0.00%		0.00	0.00%	170.7400	79,510.20	100.00%

CONSORCIO MARITIMO DEL NORTE
 DESEMBARCADERO ARTESANAL DE SUPE
 DANIEL JOAQUIN MORALES VIVA NCO
 RESIDENTE DE OBRA
 REG. CIP N° 98098



VALORIZACIÓN N° 18 DEL 01 AL 28 DE FEBRERO DE 2019 (PRECIOS UNITARIOS)

Contrato N° 025-2017- FONDEPES Ejecucion de la Obra: MEJORAMIENTO DE LOS SERVICIOS DEL DESEMBARCADERO PESQUERO ARTESANAL DE SUPE, REGION LIMA, PROVINCIA DE BARRANCA, DISTRITO DE SUPE PUERTO



OBRA: MEJORAMIENTO DE LOS SERVICIOS DEL DESEMBARCADERO PESQUERO ARTESANAL DE SUPE .REGION LIMA. PROVINCIA DE BARRANCA. DISTRITO DE SUPE PUERTO
 SUB PRES OBRAS PORTUARIAS
 PROP. FONDEPES
 CONT. CONSORCIO MARITIMO DEL NORTE
 SUP. CESEL

FECHA: mié 27 Feb 2019

ITEM	DESCRIPCION	PRESUPUESTO			VAL. ACUM. ANTERIOR			VAL. ACTUAL			VAL. ACUM. ACTUAL			SALDOS			
		Und.	Metrado	Precio (S/.)	Parcial (S/.)	Metrado	Parcial (S/.)	%	Metrado	Parcial (S/.)	%	Metrado	Parcial (S/.)	%	Metrado	Parcial (S/.)	%
01.03.07.06	DESCABEZADO DE PILOTE	und	47.00	72.02	3,384.94												
01.03.07.07	COLOCACIÓN DE VIGAS TRANSVERSALES	und	9.00	2,790.36	25,113.24		0.00	0.00%	0.00	0.00	0.00%	0.00	0.00	0.00%	47.0000	3,384.94	100.00%
01.03.07.08	COLOCACIÓN DE LOSA NERVADA	und	33.00	1,457.83	48,108.39		0.00	0.00%	0.00	0.00	0.00%	0.00	0.00	0.00%	33.0000	48,108.39	100.00%
01.04	OBRAS COMPLEMENTARIAS EN PUENTE Y CABEZO																
01.04.01	SUMINISTRO Y COLOCACION SARDINELES DE MADERA 8"X8"	und	82.60	121.26	10,016.08		0.00	0.00%	0.00	0.00	0.00%	0.00	0.00	0.00%	82.6000	10,016.08	100.00%
01.04.02	SUMINISTRO Y COLOCACION BITAS METÁLICAS 30 BRT	und	8.00	533.23	4,265.84		0.00	0.00%	0.00	0.00	0.00%	0.00	0.00	0.00%	8.0000	4,265.84	100.00%
01.04.03	SUMINISTRO Y MONTAJE PESCANTE CAP. W=500kg	und	3.00	1,633.81	4,901.43		0.00	0.00%	0.00	0.00	0.00%	0.00	0.00	0.00%	3.0000	4,901.43	100.00%
01.04.04	FABRICACIÓN DE PILOTES METÁLICOS H, PARANTES DE	m	768.80	415.10	318,796.80		0.00	0.00%	0.00	0.00	0.00%	0.00	0.00	0.00%	768.0000	318,796.80	100.00%
01.04.05	FABRICACIÓN DE VIGAS METÁLICOS (LARGEROS DE DEFENSA)	m	246.80	430.63	106,279.48		0.00	0.00%	0.00	0.00	0.00%	0.00	0.00	0.00%	246.8000	106,279.48	100.00%
01.04.06	SUMINISTRO Y COLOCACION DE BLOCS DE JEBE HUECO 6"X6"	und	60.00	175.36	10,521.60		0.00	0.00%	0.00	0.00	0.00%	0.00	0.00	0.00%	60.0000	10,521.60	100.00%
01.04.07	HINCADO DE PARANTES METÁLICOS SECCIÓN H 8"X8"X6mm	und	64.00	752.53	48,161.92		0.00	0.00%	0.00	0.00	0.00%	0.00	0.00	0.00%	64.0000	48,161.92	100.00%
01.04.08	MONTAJE DE VIGAS H (6"X6"), LONG. C/PARANTES, INC.	und	246.80	123.34	30,440.31		0.00	0.00%	0.00	0.00	0.00%	0.00	0.00	0.00%	246.8000	30,440.31	100.00%
01.04.09	SUMINISTRO Y COLOCACION DE DEFENSAS TIPO D	m	224.00	752.50	168,560.00		0.00	0.00%	0.00	0.00	0.00%	0.00	0.00	0.00%	224.0000	168,560.00	100.00%
01.04.10	BARANDA DE TUBERIA DE ACERO, EN PUENTE Y ESCALINATA DE	m	258.40	151.46	39,137.26		0.00	0.00%	0.00	0.00	0.00%	0.00	0.00	0.00%	258.4000	39,137.26	100.00%
01.04.11	PINTURA DE PARANTES Y VIGAS LONGITUDINALES EN DEFENSA	m ²	1,014.00	49.92	50,618.88		0.00	0.00%	0.00	0.00	0.00%	0.00	0.00	0.00%	1,014.0000	50,618.88	100.00%
01.05	ENROCADO DE PROTECCIÓN Y TERRAPLEN																
01.05.01	CORTE DE MATERIAL ARENA, EN UÑA DE ENROCADO	m ³	1,092.15	2.71	2,959.73		0.00	0.00%	0.00	0.00	0.00%	0.00	0.00	0.00%	1,092.1500	2,959.73	100.00%
01.05.02	ELIMINACION DE MATERIAL ARENA EN UÑA DE ENROCADO	m ³	1,638.23	8.30	13,597.31		0.00	0.00%	0.00	0.00	0.00%	0.00	0.00	0.00%	1,638.2300	13,597.31	100.00%
01.05.03	SUMINISTRO Y COLOCACION DE ROCA FILTRO > A 50kg.	m ³	3,003.42	154.21	463,157.40		0.00	0.00%	0.00	0.00	0.00%	0.00	0.00	0.00%	3,003.4200	463,157.40	100.00%
01.05.04	SUMINISTRO Y COLOCACION DE ROCA INTERMEDIA DE 0.3T A	m ³	2,784.99	185.05	515,362.40		0.00	0.00%	0.00	0.00	0.00%	0.00	0.00	0.00%	2,784.9900	515,362.40	100.00%
01.05.05	SUMINISTRO Y COLOCACION DE ROCA CORAZA DE 3.0T A 4.0T	m ³	2,784.99	154.21	429,473.31		0.00	0.00%	0.00	0.00	0.00%	0.00	0.00	0.00%	2,784.9900	429,473.31	100.00%
01.05.11	CONFORMACIÓN DE TERRAPLENES R=1.010 m3/día	m ³	19,384.99	6.56	127,165.53		0.00	0.00%	0.00	0.00	0.00%	0.00	0.00	0.00%	19,384.9900	127,165.53	100.00%
01.05.12	CORTE DE MATERIAL GRAVA, EN ARENA DE OPERACIONES	m ³	1,176.00	2.71	3,186.96		0.00	0.00%	0.00	0.00	0.00%	0.00	0.00	0.00%	1,176.0000	3,186.96	100.00%
01.05.13	ELIMINACION DE MATERIAL GRAVA, EN ARENA DE OPERACIONES	m ³	186.30	8.33	1,551.88		0.00	0.00%	0.00	0.00	0.00%	0.00	0.00	0.00%	186.3000	1,551.88	100.00%
	COSTO DIRECTO				7,268,506.65		2,702,094.58	0.21%		361,892.06	4.98%		3,063,986.63	42.15%		4,204,520.02	57.85%
	GASTOS GENERALES				1,459,801.84		542,686.80			72,682.15			615,368.95			844,432.89	
	UTILIDAD				168,809.56		62,755.59			8,404.87			71,160.46			97,649.11	
	SUB TOTAL				8,897,118.06		3,307,536.97			442,979.08			3,750,516.04			5,146,602.02	
	IGV 18%		18.00%		1,601,481.25		595,356.65			79,736.23			675,092.89			926,388.36	
	PRESUPUESTO TOTAL				10,498,599.31		3,902,893.62			522,715.31			4,425,608.93			6,072,990.38	

CONSORCIO MARITIMO DEL NORTE
 DESEMBARCADERO ARTESANAL DE SUPE

 DANIEL JOAQUIN MORALES VIVANCO
 RESIDENTE DE OBRA
 REG. CIP N° 98098

0
0
0
0
0
0



VALORIZACIÓN N° 18 DEL 01 AL 28 DE FEBRERO DE 2019 (PRECIOS UNITARIOS)

Contrato N° 025-2017- FONDEPES Ejecución de la Obra: MEJORAMIENTO DE LOS SERVICIOS DEL DESEMBARCADERO PESQUERO ARTESANAL DE SUPE, REGION LIMA, PROVINCIA DE BARRANCA, DISTRITO DE SUPE PUERTO



OBRA: MEJORAMIENTO DE LOS SERVICIOS DEL DESEMBARCADERO PESQUERO ARTESANAL DE SUPE .REGION LIMA, PROVINCIA DE BARRANCA, DISTRITO DE SUPE PUERTO
 SUB PRES: OBRAS EN TIERRA - ESTRUCTURA
 PROP. PRES: FONDEPES
 CONT. PRES: CONSORCIO MARITIMO DEL NORTE
 SUP. PRES: CESEL

FECHA: mié 27 Feb 2019

ITEM	DESCRIPCION	PRESUPUESTO			VAL. ACUM. ANTERIOR			VAL. ACTUAL			VAL. ACUM. ACTUAL			SALDOS			
		Und.	Metrado	Precio (S/.)	Parcial (S/.)	Metrado	Parcial (S/.)	%	Metrado	Parcial (S/.)	%	Metrado	Parcial (S/.)	%	Metrado	Parcial (S/.)	%
02	ESTRUCTURAS EN TIERRA																
02.01	OBRAS PRELIMINARES																
02.01.01	LIMPIEZA DEL TERRENO	m ²	3,919.14	1.78	6,976.07	3,919.14	S/6,976.07	100.00%	0.00	0.00%	3,919.14	6,976.07	100.00%	0.00	0.00	0.00%	
02.01.02	TRAZO Y REPLANTEO EDIFICACIONES	m ²	3,919.14	1.48	5,800.33	3,879.95	S/5,742.32	99.00%	0.00	0.00%	3,879.95	5,742.32	99.00%	39.19	58.00	1.00%	
02.02	DEMOLICIONES																
02.02.01	DEMOLICIÓN DE VIGAS Y LOSAS MATERIAL NOBLE	m ³	113.59	70.76	8,037.63	113.59	S/8,037.63	100.00%	0.00	0.00%	113.59	8,037.63	100.00%	0.00	0.00	0.00%	
02.02.02	DEMOLICIÓN DE COLUMNAS Y MUROS	m ³	136.46	53.07	7,241.93	136.46	S/7,241.93	100.00%	0.00	0.00%	136.46	7,241.93	100.00%	0.00	0.00	0.00%	
02.02.03	DEMOLICION DE PISO DE CONCRETO	m ²	3,698.88	24.16	89,364.94	3,698.88	S/89,364.94	100.00%	0.00	0.00%	3,698.88	89,364.94	100.00%	0.00	0.00	0.00%	
02.02.04	DEMOLICIÓN DE CIMENTACIONES	m ³	240.00	88.48	21,235.20	240	S/21,235.20	100.00%	0.00	0.00%	240	21,235.20	100.00%	0.00	0.00	0.00%	
02.02.05	DESMONTAJE Y DEMOLICION DE INFRAESTRUCTURA SANITARIA Y ELECTRICA MENORES	m ²	260.00	5.76	1,502.80	260	S/1,502.80	100.00%	0.00	0.00%	260	1,502.80	100.00%	0.00	0.00	0.00%	
02.02.06	ELIMINACION MATERIAL PROCEDENTE DE DEMOLICIÓN	m ³	1,070.88	23.27	24,919.38	1,070.88	S/24,919.38	100.00%	0.00	0.00%	1,070.88	24,919.38	100.00%	0.00	0.00	0.00%	
02.03	MOVIMIENTO DE TIERRAS																
02.03.01	CORTE MASIVO	m ³	7,838.24	6.37	49,929.59	7,196.17	S/45,839.60	91.81%	61.17	389.55	0.78%	7,257.34	46,229.26	92.59%	580.90	3,700.33	7.41%
02.03.02	RELLENO MASIVO CON MATERIAL DE PRESTAMO	m ³	8,104.56	86.18	698,450.98	7,139.61	S/615,291.70	88.09%	0.00	0.00%	7,139.61	615,291.70	88.09%	964.95	83,159.28	11.91%	
02.03.03	ELIMINACION DE MATERIAL EXCEDENTE CON EQUIPO	m ³	7,935.91	10.00	79,359.10	7,355.00	S/73,550.01	92.68%	0.00	0.00%	7,355.00	73,550.01	92.68%	580.91	5,809.09	7.32%	
02.03.04	NIVELACION Y APISONADO PARA FALSO PISO, PATIO Y VEREDAS.	m ²	3,919.14	8.28	32,450.48	0.00	S/0.00	0.00%	0.00	0.00%	0.00	0.00	0.00%	3,919.14	32,450.48	100.00%	
02.03.05	AFIRMADO PARA FALSO PISO Y VEREDAS	m ²	1,242.59	27.52	34,196.08	0.00	S/0.00	0.00%	0.00	0.00%	0.00	0.00	0.00%	1,242.59	34,196.08	100.00%	
02.03.06	AFIRMADO PARA PATIO DE MANIOBRAS Y PASTILLOS	m ²	2,475.23	26.91	66,608.44	0.00	S/0.00	0.00%	0.00	0.00%	0.00	0.00	0.00%	2,475.23	66,608.44	100.00%	
02.04	CONCRETO SIMPLE																
02.04.01	CIMIENTO CORRIDO																
02.04.01.01	CONCRETO CICLOPEO f'c=210 kg/cm2 + 30% P.G.	m ³	22.30	360.79	8,045.62	20.59	S/7,428.67	92.33%	0.00	0.00%	20.59	7,428.67	92.33%	1.71	616.95	7.67%	
02.04.01.02	ENCOFRADO Y DESENCOFRADO CIMIENTO CORRIDO	m ²	130.06	55.45	7,211.83	58.18	S/3,226.08	44.73%	0.00	0.00%	58.18	3,226.08	44.73%	71.88	3,985.75	55.27%	
02.04.02	CIMIENOS																
02.04.02.01	CONCRETO f'c=175 kg/cm2 CIMIENOS CERCO PERIMETRICO	m ³	41.81	390.84	16,341.02	41.81	S/16,341.02	100.00%	0.00	0.00%	41.81	16,341.02	100.00%	0.00	0.00	0.00%	
02.04.02.02	ENCOFRADO Y DESENCOFRADO CIMIENTO CERCO	m ²	348.38	55.45	19,317.67	177.79	S/9,858.46	51.03%	27.51	1,525.43	7.90%	205.3	11,383.89	58.93%	143.08	7,933.79	41.07%
02.04.03	SOBRECIMIENOS																
02.04.03.01	CONCRETO SOBRECIMIENOS f'c=175 kg/cm2	m ³	27.87	419.43	11,689.51	14.47	S/6,069.30	51.92%	0.00	0.00%	14.47	6,069.30	51.92%	13.40	5,620.22	48.08%	
02.04.03.02	ENCOFRADO Y DESENCOFRADO DE SOBRECIMIENTO	m ²	278.70	55.87	15,570.97	227.90	S/12,732.77	81.77%	0.00	0.00%	227.90	12,732.77	81.77%	50.80	2,838.20	18.23%	
02.05	CONCRETO ARMADO																
02.05.01	ZAPATAS																
02.05.01.01	CONCRETO f'c=280 kg/cm2 ZAPATAS	m ³	213.74	422.82	90,373.55	206.23	S/87,198.17	96.49%	2.00	845.64	0.94%	208.23	88,043.81	97.53%	5.51	2,329.74	2.58%
02.05.01.02	ENCOFRADO Y DESENCOFRADO DE ZAPATAS	m ²	614.39	64.53	39,646.59	492.95	S/31,810.06	80.23%	8.00	516.24	1.30%	500.95	32,326.30	81.54%	113.44	7,320.28	18.46%
02.05.01.03	ACERO CORRUGADO ZAPATAS FY= 4200 kg/cm2	kg	5,809.38	4.22	24,515.58	5,809.38	S/24,515.58	100.00%	0.00	0.00%	5,809.38	24,515.58	100.00%	0.00	0.00	0.00%	
02.05.01.04	SOLO PARA ZAPATAS DE CONCRETO Fc=280 MPa A 1'2	m ²	472.88	44.64	19,082.71	0.00	S/0.00	0.00%	0.00	0.00%	0.00	0.00	0.00%	472.88	19,082.71	100.00%	
02.05.01.05	ENCOFRADO Y DESENCOFRADO SOLADOS DE ZAPATAS	m ²	122.88	64.53	7,929.43	0.00	S/0.00	0.00%	0.00	0.00%	0.00	0.00	0.00%	122.88	7,929.43	100.00%	
02.05.02	VIGAS DE CIMENTACIÓN																
02.05.02.01	CONCRETO f'c=280 kg/cm2 VIGAS DE CIMENTACIÓN	m ³	193.34	463.24	89,562.82	125.03	S/57,918.90	64.67%	0.00	0.00%	125.03	57,918.90	64.67%	68.31	31,643.92	95.33%	
02.05.02.02	ENCOFRADO Y DESENCOFRADO DE VIGAS DE CIMENTACIÓN	m ²	1,128.33	55.45	62,565.90	857.14	S/47,528.41	75.97%	0.00	0.00%	857.14	47,528.41	75.97%	271.19	15,037.49	24.03%	

CONSORCIO MARITIMO DEL NORTE
 DESEMBARCADERO ARTESANAL DE SUPE
 DANIEL JOAQUIN MORALES VIVANCO
 RESIDENTE DE OBRA
 REG. CIP N° 98088



VALORIZACIÓN N° 18 DEL 01 AL 28 DE FEBRERO DE 2019 (PRECIOS UNITARIOS)

Contrato N° 025-2017- FONDEPES Ejecución de la Obra: MEJORAMIENTO DE LOS SERVICIOS DEL DESEMBARCADERO PESQUERO ARTESANAL DE SUPE, REGION LIMA, PROVINCIA DE BARRANCA, DISTRITO DE SUPE PUERTO



OBRA: MEJORAMIENTO DE LOS SERVICIOS DEL DESEMBARCADERO PESQUERO ARTESANAL DE SUPE ,REGION LIMA, PROVINCIA DE BARRANCA, DISTRITO DE SUPE PUERTO
 SUB PRES OBRAS EN TIERRA - ESTRUCTURA
 PROP. FONDEPES
 CONT. CONSORCIO MARITIMO DEL NORTE
 SUP. CESEL

FECHA: mié 27 Feb 2019

ITEM	DESCRIPCION	PRESUPUESTO			VAL. ACUM. ANTERIOR			VAL. ACTUAL			VAL. ACUM. ACTUAL			SALDOS			
		Und.	Metrado	Precio (S./.)	Parcial (S./.)	Metrado	Parcial (S./.)	%	Metrado	Parcial (S./.)	%	Metrado	Parcial (S./.)	%	Metrado	Parcial (S./.)	%
02.05.02.03	ACERO CORRUGADO VIGAS DE CIMENTACION FY= 4200	m	18,632.99	4.22	78,631.22	14843.8134	S/62,640.89	79.66%		0.00	0.00%	14843.813	62,640.89	79.66%	3,789.18	15,990.33	20.34%
02.05.03	SOBRECIMENTOS REFORZADOS																0.00
02.05.03.01	CONCRETO Fc=280 kg/cm2 SOBRECIMENTOS	m3	62.54	415.72	25,999.13	62.54	S/25,999.13	100.00%	0.00	0.00	0.00%	62.54	25,999.13	100.00%	0.00	0.00	0.00%
02.05.03.02	ENCOFRADO Y DESENCOFRADO DE SOBRECIMIENTO REFORZADO	m2	611.27	43.78	26,761.40	611.27	S/26,761.40	100.00%	34.95	1,529.89	5.72%	646.22	28,291.29	105.72%	0.00	0.00	0.00%
02.05.03.03	ACERO CORRUGADO SOBRECIMIENTO FY= 4200 kg/cm2	m	3,279.53	4.22	13,839.62	3,279.53	S/13,839.62	100.00%	0.00	0.00	0.00%	3,279.53	13,839.62	100.00%	0.00	0.00	0.00%
02.05.04	COLUMNAS Y PLACAS																0.00
02.05.04.01	CONCRETO Fc=210 kg/cm2 COLUMNAS	m3	178.49	534.42	95,388.63	178.49	S/95,388.63	100.00%	0.00	0.00	0.00%	178.49	95,388.63	100.00%	0.00	0.00	0.00%
02.05.04.02	ENCOFRADO Y DESENCOFRADO COLUMNAS	m2	1,784.90	58.69	104,755.78	1,784.90	S/104,755.78	100.00%	0.00	0.00	0.00%	1,784.90	104,755.78	100.00%	0.00	0.00	0.00%
02.05.04.03	ACERO CORRUGADO FY= 4200 kg/cm2 COLUMNAS Y PLACAS	m	29,933.86	4.22	126,320.89	29,933.86	S/126,320.89	100.00%	0.00	0.00	0.00%	29,933.86	126,320.89	100.00%	0.00	0.00	0.00%
02.05.05	LOSAS ARMADAS Y RAMPAS																0.00
02.05.05.01	CONCRETO Fc= 210 kg/cm2, LOSAS ARMADAS Y RAMPAS	m3	658.45	398.20	262,194.79	322.64	S/128,474.65	49.00%	47.31	18,837.25	7.18%	369.94	147,311.90	56.18%	288.51	114,882.89	43.82%
02.05.05.02	ACERO CORRUGADO LOSAS ARMADAS Y RAMPAS FY= 4200	m	23,980.12	4.22	101,196.11	23,192.58	S/97,872.68	96.72%	787.54	3,323.42	3.28%	23,980.12	101,196.10	100.00%	0.00	0.01	0.00%
02.05.06	VIGAS																0.00
02.05.06.01	CONCRETO Fc=210 kg/cm2 EN VIGAS	m3	143.10	412.74	59,063.09	138.07	S/56,987.01	96.48%	1.77	732.11	1.24%	139.84	57,719.12	97.72%	3.26	1,343.98	2.28%
02.05.06.02	ENCOFRADO Y DESENCOFRADO NORMAL EN VIGAS	m2	912.92	67.27	61,412.13	912.92	S/61,412.13	100.00%	0.00	0.00	0.00%	912.92	61,412.13	100.00%	0.00	0.00	0.00%
02.05.06.03	ACERO fy=4200 kg/cm2 GRADO 60 en VIGAS	m	14,857.17	4.22	62,697.26	14,857.17	S/62,697.26	100.00%	0.00	0.00	0.00%	14,857.17	62,697.26	100.00%	0.00	0.00	0.00%
02.05.07	LOSAS ALIGERADAS																0.00
02.05.07.01	LADRILLO HUECO DE ARCILLA h=15 cm PARA TECHO	m3	10,691.86	3.07	32,824.01	10,691.86	S/32,824.01	100.00%	0.00	0.00	0.00%	10,691.86	32,824.01	100.00%	0.00	0.00	0.00%
02.05.07.02	CONCRETO Fc= 210 kg/cm2, LOSA ALIGERADA	m3	115.52	401.61	46,393.99	115.52	S/46,393.99	100.00%	0.00	0.00	0.00%	115.52	46,393.99	100.00%	0.00	0.00	0.00%
02.05.07.03	ENCOFRADO Y DESENCOFRADO NORMAL EN LOSAS	m2	1,389.39	42.72	59,354.74	1,389.39	S/59,354.74	100.00%	0.00	0.00	0.00%	1,389.39	59,354.74	100.00%	0.00	0.00	0.00%
02.05.07.04	ACERO fy=4200 kg/cm2 GRADO 60 en LOSAS ALIGERADAS	m	7,212.92	4.22	30,438.52	7,212.92	S/30,438.52	100.00%	0.00	0.00	0.00%	7,212.92	30,438.52	100.00%	0.00	0.00	0.00%
02.05.08	ESCALERAS																0.00
02.05.08.01	CONCRETO EN ESCALERAS Fc=210 kg/cm2	m3	7.64	412.74	3,153.33	6.13	S/2,530.10	80.24%		0.00	0.00%	6.13	2,530.10	80.24%	1.51	623.24	19.76%
02.05.08.02	ENCOFRADO Y DESENCOFRADO NORMAL EN ESCALERAS	m2	45.66	67.27	3,071.55	38.11	S/2,563.66	83.46%		0.00	0.00%	38.11	2,563.66	83.46%	7.55	507.89	16.54%
02.05.08.03	ACERO fy=4200 kg/cm2 GRADO 60 en ESCALERAS	m	1,416.81	4.22	5,978.94	757.40	S/3,196.23	53.46%		0.00	0.00%	757.40	3,196.23	53.46%	659.41	2,782.71	46.54%
02.06	ESTRUCTURAS SANITARIAS																0.00
02.06.01	CISTERNA																0.00
02.06.01.01	CONCRETO CISTENA Fc=210 kg/cm2	m3	40.83	546.13	22,298.49	0	S/0.00	0.00%		0.00	0.00%	0	0.00	0.00%	40.83	22,298.49	100.00%
02.06.01.02	ENCOFRADO Y DESENCOFRADO EN CISTERNA	m2	336.09	58.62	19,701.60	0.00	S/0.00	0.00%		0.00	0.00%	0.00	0.00	0.00%	336.09	19,701.60	100.00%
02.06.01.03	ACERO CORRUGADO CISTERNA FY= 4200 kg/cm2	m	3,543.64	4.20	14,883.29	0	S/0.00	0.00%		0.00	0.00%	0.00	0.00	0.00%	3,543.64	14,883.29	100.00%
02.06.02	TANQUE ELEVADO																0.00
02.06.02.01	CONCRETO Fc=280 kg/cm2 TANQUE ELEVADO	m3	52.95	590.94	31,290.27		S/0.00	0.00%		0.00	0.00%	0.00	0.00	0.00%	52.95	31,290.27	100.00%
02.06.02.02	ENCOFRADO Y DESENCOFRADO TANQUE ELEVADO	m2	150.33	49.90	7,501.47		S/0.00	0.00%		0.00	0.00%	0.00	0.00	0.00%	150.33	7,501.47	100.00%
02.06.02.03	ACERO CORRUGADO FY= 4200 kg/cm2 TANQUE ELEVADO	m	1,878.59	4.20	7,890.08		S/0.00	0.00%		0.00	0.00%	0.00	0.00	0.00%	1,878.59	7,890.08	100.00%
02.06.03	TANQUE SÉPTICO																0.00
02.06.03.01	CONCRETO Fc=280 kg/cm2 TANQUE SÉPTICO	m3	20.18	589.76	11,901.36		S/0.00	0.00%		0.00	0.00%	0	0.00	0.00%	20.18	11,901.36	100.00%
02.06.03.02	ENCOFRADO Y DESENCOFRADO EN TANQUE SÉPTICO	m2	128.75	49.90	6,424.63		S/0.00	0.00%		0.00	0.00%	0.00	0.00	0.00%	128.75	6,424.63	100.00%

CONSORCIO MARITIMO DEL NORTE
 DESEMBARCADERO ARTESANAL DE SUPE
 DANIEL JOAQUIN MORALES-VIVANCO
 RESIDENTE DE OBRA
 REG. CIP N° 98098

C
 O
 A



VALORIZACIÓN N° 18 DEL 01 AL 28 DE FEBRERO DE 2019 (PRECIOS UNITARIOS)

Contrato N° 025-2017- FONDEPES Ejecucion de la Obra: MEJORAMIENTO DE LOS SERVICIOS DEL DESEMBARCADERO PESQUERO ARTESANAL DE SUPE, REGION LIMA, PROVINCIA DE BARRANCA, DISTRITO DE SUPE PUERTO



OBRA: MEJORAMIENTO DE LOS SERVICIOS DEL DESEMBARCADERO PESQUERO ARTESANAL DE SUPE .REGION LIMA. PROVINCIA DE BARRANCA. DISTRITO DE SUPE PUERTO
 SUB PRES OBRAS EN TIERRA - ESTRUCTURA
 PROP. FONDEPES
 CONT. CONSORCIO MARITIMO DEL NORTE
 SUP. CESEL

FECHA: mié 27 Feb 2019

ITEM	DESCRIPCION	PRESUPUESTO			VAL. ACUM. ANTERIOR			VAL. ACTUAL			VAL. ACUM. ACTUAL			SALDOS			
		Und.	Metrado	Precio (\$/.)	Parcial (\$/.)	Metrado	Parcial (\$/.)	%	Metrado	Parcial (\$/.)	%	Metrado	Parcial (\$/.)	%	Metrado	Parcial (\$/.)	%
02.06.03.03	ACERO CORRUGADO TANQUE SÉPTICO FY= 4200 kg/cm2	kg	1,027.85	4.20	4,316.97		S/0.00	0.00%		0.00	0.00%	0	0.00	0.00%	1,027.85	4,316.97	100.00%
02.06.04	ESTRUCTURAS SANITARIAS MENORES									0.00	0.00%					0.00	
02.06.04.01	TRAMPA DE GRASAS	und	1.00	1,036.44	1,036.44		S/0.00	0.00%		0.00	0.00%	0	0.00	0.00%	1.00	1,036.44	100.00%
02.06.04.02	TRAMPA DE SOLIDOS	und	1.00	885.76	885.76		S/0.00	0.00%		0.00	0.00%	0	0.00	0.00%	1.00	885.76	100.00%
02.06.04.03	CÁMARA DE REUNIÓN	und	1.00	1,803.54	1,803.54		S/0.00	0.00%		0.00	0.00%	0	0.00	0.00%	1.00	1,803.54	100.00%
02.07	ESTRUCTURA METÁLICA Y COBERTURAS									0.00						0.00	
02.07.01	COBERTURA EN TIERRA									0.00						0.00	
02.07.01.01	ARRIOSTRE DE TIJERALES	m	80.00	244.97	19,597.60		S/0.00	0.00%		0.00	0.00%	0.00	0.00	0.00%	80.00	19,597.60	100.00%
02.07.01.02	TIJERAL METÁLICO SEGÚN DETALLE	und	20.00	602.48	12,049.60		S/0.00	0.00%		0.00	0.00%	0	0.00	0.00%	20.00	12,049.60	100.00%
02.07.01.03	ANCLAJE DE TIJERAL CON LOSA SEGÚN DETALLE CORREAS METÁLICAS	und	20.00	585.02	11,700.40	9.00	S/5,265.18	45.00%		0.00	0.00%	9.00	5,265.18	45.00%	11.00	6,435.22	55.00%
02.07.01.04	CORREAS METÁLICAS	m	120.00	1.57	188.40		S/0.00	0.00%		0.00	0.00%	0	0.00	0.00%	120.00	188.40	100.00%
02.07.02	COBERTURA EN CABEZO									0.00						0.00	
02.07.02.01	POSTE METÁLICO	und	80.00	348.29	27,863.20		S/0.00	0.00%		0.00	0.00%	0	0.00	0.00%	80.00	27,863.20	100.00%
02.07.02.02	ARCO PRINCIPAL TUB 1 1/2" E=3mm	m	50.00	27.53	1,376.50		S/0.00	0.00%		0.00	0.00%	0.00	0.00	0.00%	50.00	1,376.50	100.00%
02.07.02.03	LARGUERO METÁLICO EN ARCO	m	110.00	43.35	4,768.50		S/0.00	0.00%		0.00	0.00%	0	0.00	0.00%	110.00	4,768.50	100.00%
02.07.02.04	CORREAS METÁLICAS	m	500.00	1.57	785.00		S/0.00	0.00%		0.00	0.00%	0.00	0.00	0.00%	500.00	785.00	100.00%
02.07.03	ARMADURAS PARA TUBERIA COLGADA EN TAREAS									0.00						0.00	
02.07.03.01	ARMADURA METÁLICA TIPO 1 TUBERIA COLGADA	und	7.00	304.16	2,129.12		S/0.00	0.00%		0.00	0.00%	0.00	0.00	0.00%	7.00	2,129.12	100.00%
02.07.03.02	ARMADURA METÁLICA TIPO 2 TUBERIA COLGADA	und	7.00	216.52	1,515.64		S/0.00	0.00%		0.00	0.00%	0	0.00	0.00%	7.00	1,515.64	100.00%
02.08	VARIOS									0.00						0.00	
02.08.01	LIMPIEZA DURANTE LA EJECUCION DE OBRA	mes	10.00	849.99	8,499.90	9	S/7,649.91	90.00%		0.00	0.00%	9	7,649.91	90.00%	1.00	849.99	10.00%
02.08.02	DESMONTAJE DE EQUIPOS DE FRIO EXISTENTES	op	1.00	38,517.63	38,517.63	1.00	S/38,517.63	100.00%		0.00	0.00%	1.00	38,517.63	100.00%	0.00	0.00	0.00%
02.08.03	TOMA DE MUESTRAS PARA ENSAYO DE COMPRESIÓN	und	200.00	51.35	10,270.00	200	S/10,270.00	100.00%		0.00	0.00%	200	10,270.00	100.00%	0.00	0.00	0.00%
02.08.04	ROTURA DE PROBETA- ENSAYO DE COMPRESIÓN	und	200.00	45.51	9,102.00	200.00	S/9,102.00	100.00%		0.00	0.00%	200.00	9,102.00	100.00%	0.00	0.00	0.00%
	COSTO DIRECTO				3,015,698.69		2,315,585.04	76.78%		27,699.63	0.92%		2,343,284.66	77.70%		673,943.87	22.39%
	GASTOS GENERALES		20.083931%		605,670.84		465,060.50			5,583.17			470,623.67			135,354.42	
	UTILIDAD		2.32247929%		70,038.98		53,778.98			643.32			54,422.30			15,652.21	
	SUB TOTAL				3,691,408.51		2,834,424.52			33,906.12			2,868,330.63			824,950.49	
	IGY 18%		18.00%		664,453.53		510,196.41			6,102.10			516,299.51			148,491.09	
	PRESUPUESTO TOTAL				4,355,862.04		3,344,620.93			40,009.22			3,384,630.15			973,441.58	

CONSORCIO MARITIMO DEL NORTE
 DESEMBARCADERO ARTESANAL DE SUPE

DANIEL JOAQUIN MORALES VIVACO
 RESIDENTE DE OBRA
 REG. CIP N° 98098

000000

OBRA: MEJORAMIENTO DE LOS SERVICIOS DEL DESEMBARCADERO PESQUERO ARTESANAL DE SUPE, REGION LIMA, PROVINCIA DE BARRANCA, DISTRITO DE SUPE PUERTO
 SUB PRES: OBRAS EN TIERRA - AROQUITECTURA
 PROP: FONDEPES
 CONT: CONSORCIO MARITIMO DEL NORTE
 SUP: CESEL

FECHA: mié 27 Feb 2019

ITEM	DESCRIPCION	PRESUPUESTO			VAL. ACUM. ANTERIOR			VAL ACTUAL			VAL. ACUM. ACTUAL			SALDOS			
		Und.	Metrado	Precio (S./.)	Parcial (S./.)	Metrado	Parcial (S./.)	%	Metrado	Parcial (S./.)	%	Metrado	Parcial (S./.)	%	Metrado	Parcial (S./.)	%
03	ARQUITECTURA																
03.01	ALBAÑILERIA																
03.01.01	MURO DE LADRILLO KING KONG E=0.15m.	m2	1,296.96	60.33	78,245.60	760.70	45,893.03	0.00%	178.05	10,741.97	13.73%	938.75	56,635.00	72.38%	358.21	21,610.60	27.62%
03.01.02	MURO DE LADRILLO KING KONG E=0.25m	m2	749.28	95.84	71,811.00	749.28	71,811.00	0.00%		0.00	0.00%	749.28	71,811.00	100.00%	0.00	0.00	0.00%
03.01.03	MURO LADRILLO KING KONG E=0.10m.	m2	17.70	49.54	876.86	6.72	332.91	0.00%		0.00	0.00%	6.72	332.91	37.97%	10.98	543.95	62.03%
03.02	REVOQUES ENLUCIDOS Y MOLDURAS				0.00												
03.02.01	TARRAJEO EN INTERIORES ACABADO CON CEMENTO-ARENA	m2	2,735.63	33.24	90,932.34	2,503.15	83,204.71	0.00%	232.48	7,727.50	8.50%	2,735.63	90,932.21	100.00%	0.00	0.13	0.00%
03.02.02	TARRAJEO EN EXTERIORES ACABADO CEMENTO- ARENA	m2	3,183.98	42.66	135,828.59	1,670.76	71,274.62	0.00%	638.69	27,246.48	20.06%	2,309.45	98,521.11	72.53%	874.53	37,307.48	27.47%
03.02.03	TARRAJEO CON IMPERMEABILIZANTES	m2	270.07	34.88	9,420.04	0.00	0.00	0.00%		0.00	0.00%	0.00	0.00	0.00%	270.07	9,420.04	100.00%
03.02.04	TARRAJEO DEL TIPO RAYADO O PRIMARIO C/MORTERO 1:5	m2	276.72	26.91	7,446.54	276.72	7,446.54	0.00%		0.00	0.00%	276.72	7,446.54	100.00%	0.00	0.00	0.00%
03.02.05	VESTIDURA DE DERRAMES ANCHO = 15cm	m	662.75	12.72	8,430.18	539.52	6,862.69	0.00%	123.23	1,567.49	18.59%	662.75	8,430.18	100.00%	0.00	0.00	0.00%
03.03	CIELORRASOS				0.0000												
03.03.01	CIELORRASOS CON MEZCLA DE CEMENTO ARENA	m2	1,760.09	48.76	85,821.99	1,570.66	76,585.19	0.00%		0.00	0.00%	1,570.66	76,585.19	89.24%	189.43	9,236.80	10.76%
03.04	PISOS Y PAVIMENTOS				0.0000												
03.04.01	FALSO PISO DE CONCRETO E=2"	m2	1,308.33	25.95	33,951.16	0.0000	0.00	0.00%		0.00	0.00%	0.00	0.00	0.00%	1,308.33	33,951.16	100.00%
03.04.02	CONTRAPISO DE 25mm	m2	447.90	17.29	7,744.19	0.0000	0.00	0.00%		0.00	0.00%	0.00	0.00	0.00%	447.90	7,744.19	100.00%
03.04.03	PISO DE CEMENTO PULIDO CON IMPERMEABILIZANTE	m2	3,144.88	54.37	170,987.13	0.0000	0.00	0.00%	0.00	0.00	0.00%	0.00	0.00	0.00%	3,144.88	170,987.13	100.00%
03.04.04	PISO DE CERAMICO ANTIDESLIZANTE ALTO TRAFICO	m2	366.75	65.34	23,963.45	209.2600	13,673.05	0.00%		0.00	0.00%	209.26	13,673.05	57.06%	157.49	10,290.40	42.94%
03.04.05	PISO DE VINILICO ALTO TRAFICO VEREDA	m2	116.80	34.47	4,026.10	0.0000	0.00	0.00%		0.00	0.00%	0.00	0.00	0.00%	116.80	4,026.10	100.00%
03.04.06	VEREDA	m2	468.00	67.73	31,697.64	0.0000	0.00	0.00%		0.00	0.00%	0.00	0.00	0.00%	468.00	31,697.64	100.00%
03.05	ZOCALOS Y CONTRAZOCALOS				0.0000												
03.05.01	ZOCALO DE CERAMICA COLOR 0.40 X 0.40m	m2	331.60	54.79	18,179.32	127.35	6,977.51	0.00%		0.00	0.00%	127.35	6,977.51	38.38%	204.45	11,201.82	61.62%
03.05.02	CONTRAZOCALO DE CERAMICA H=0.10 m.	m	294.60	10.81	3,184.63	66.40	717.78	0.00%		0.00	0.00%	66.40	717.78	22.54%	228.20	2,466.84	77.46%
03.05.03	CONTRAZOCALO DE CEMENTO DISEÑO SANITARIO H=10 cm	m	546.00	12.19	6,655.74	0.0000	0.00	0.00%		0.00	0.00%	0.00	0.00	0.00%	546.00	6,655.74	100.00%
03.05.04	CONTRAZOCALO DE CEDRO DE E=1", H=0.10m	m	98.20	21.91	2,151.56	0.0000	0.00	0.00%		0.00	0.00%	0.00	0.00	0.00%	98.20	2,151.56	100.00%
03.06	COBERTURAS				0.0000												
03.06.01	CUBIERTA LADRILLO PASTELERO 24x24 ASENTADO C/MEZCLA	m2	1,295.40	65.17	84,421.22	1,295.40	84,421.22	0.00%		0.00	0.00%	1,295.40	84,421.22	100.00%	0.00	0.00	0.00%
03.06.02	POLICARBONATO COLOR BLANCO, E=16mm (INC. ACCESORIO,	m2	520.00	192.79	100,250.80	0.0000	0.00	0.00%		0.00	0.00%	0.00	0.00	0.00%	520.00	100,250.80	100.00%
03.07	CARPINTERIA DE MADERA				0.0000												
03.07.01	PUERTA APANELADA DE MADERA, CON MARCO DE MAD. CEDRO	m2	65.04	291.13	18,935.10	0.0000	0.00	0.00%		0.00	0.00%	0.00	0.00	0.00%	65.04	18,935.10	100.00%
03.07.02	PUERTA CONTRA PLACADA E=45mm, TRIPLAY LUPUNA 6mm,	m2	13.20	230.98	3,048.94	0.0000	0.00	0.00%		0.00	0.00%	0.00	0.00	0.00%	13.20	3,048.94	100.00%
03.07.03	TABIQUE DE MELAMINE PARA BAÑOS Y VESTIDORES, E=15mm	m2	68.60	183.75	12,605.25	0.0000	0.00	0.00%		0.00	0.00%	0.00	0.00	0.00%	68.60	12,605.25	100.00%
03.08	CARPINTERIA METALICA				0.0000												
03.08.01	PUERTA DE ALTO IMPACTO BARRA ANTIPANICO	m2	15.84	1,129.74	17,895.08	0.0000	0.00	0.00%		0.00	0.00%	0.00	0.00	0.00%	15.84	17,895.08	100.00%
03.08.02	PUERTA DE ALTO IMPACTO, TIPO VAIVEN	m2	30.24	1,007.87	30,477.99	0.0000	0.00	0.00%		0.00	0.00%	0.00	0.00	0.00%	30.24	30,477.99	100.00%
03.08.03	PUERTA METALICA, PLANCHA 1/16", MARCO 3"X3"X3mm Y	m2	80.40	262.04	21,068.02	0.0000	0.00	0.00%		0.00	0.00%	0.00	0.00	0.00%	80.40	21,068.02	100.00%
03.08.04	PUERTA METALICA, TUBO GALVANIZADO 2", MALLA	m2	69.77	174.07	12,144.86	0.0000	0.00	0.00%		0.00	0.00%	0.00	0.00	0.00%	69.77	12,144.86	100.00%
03.08.05	PUERTA SECCIONABLE PS 2.60X3.00	und	8.00	4,347.63	34,781.04	0.0000	0.00	0.00%		0.00	0.00%	0.00	0.00	0.00%	8.00	34,781.04	100.00%
03.08.06	SUMINISTRO E INSTALACIÓN DE ABRIGO RETRACTIL	und	8.00	4,820.93	38,567.44	0.0000	0.00	0.00%		0.00	0.00%	0.00	0.00	0.00%	8.00	38,567.44	100.00%
03.08.07	BARANDA DE TUBO FIERRO GALVANIZADO PASAMANO 1 1/2"	m	82.30	136.00	11,192.80	0.0000	0.00	0.00%		0.00	0.00%	0.00	0.00	0.00%	82.30	11,192.80	100.00%
03.09	CARPINTERIA DE ALUMINIO				0.0000												
03.09.01	VENTANA DE ALUMINIO, C/VIDRIO TEMPLADO	m2	227.37	197.68	44,946.50	0.0000	0.00	0.00%		0.00	0.00%	0.00	0.00	0.00%	227.37	44,946.50	100.00%
03.09.02	VENTANA DE ALUMINIO CON MALLA MOSQUITERA	m2	128.86	114.84	14,798.28	0.0000	0.00	0.00%		0.00	0.00%	0.00	0.00	0.00%	128.86	14,798.28	100.00%
03.09.03	PUERTA ENROLLABLE DE ALUMINIO	m2	29.70	483.43	14,357.87	0.0000	0.00	0.00%		0.00	0.00%	0.00	0.00	0.00%	29.70	14,357.87	100.00%

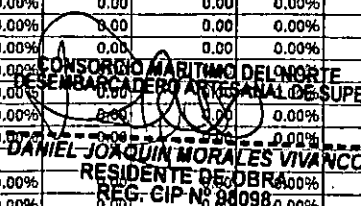

CONSORCIO MARITIMO DEL NORTE
DESEMBARCADERO ARTESANAL DE SUPE
DANIEL JOAQUIN MORALES VIVANCO
 RESIDENTE DE OBRA
 REG. CIP N° 88098



VALORIZACIÓN N° 18 DEL 01 AL 28 DE FEBRERO DE 2019
(PRECIOS UNITARIOS)

Contrato N° 025-2017- FONDEPES Ejecución de la Obra: MEJORAMIENTO DE LOS SERVICIOS DEL DESEMBARCADERO PESQUERO ARTESANAL DE SUPE, REGION LIMA, PROVINCIA DE BARRANCA, DISTRITO DE SUPE PUERTO



OBRA: MEJORAMIENTO DE LOS SERVICIOS DEL DESEMBARCADERO PESQUERO ARTESANAL DE SUPE ,REGION LIMA, PROVINCIA DE BARRANCA, DISTRITO DE SUPE PUERTO
 SUB PRES OBRAS EN TIERRA - AROUITECTURA
 PROP. FONDEPES
 CONT. CONSORCIO MARITIMO DEL NORTE
 SUP. CESEL

FECHA: mié 27 Feb 2019

ITEM	DESCRIPCION	PRESUPUESTO				VAL. ACUM. ANTERIOR			VAL. ACTUAL			VAL. ACUM. ACTUAL			SALDOS		
		Und.	Metrado	Precio (S/.)	Parcial (S/.)	Metrado	Parcial (S/.)	%	Metrado	Parcial (S/.)	%	Metrado	Parcial (S/.)	%	Metrado	Parcial (S/.)	%
03.10	CERRAJERIA					0.0000											
03.10.01	CERRADURA DOS GOLPES EN PUERTA CON TIRADOR	und	15.00	95.99	1,438.95	0.0000	0.00	0.00%		0.00	0.00%	0.00	0.00	0.00%	15.00	1,438.95	100.00%
03.10.02	CERRADURA DE PERILLA PARA PUERTAS INTERIORES	und	33.00	64.53	2,129.49	0.0000	0.00	0.00%		0.00	0.00%	0.00	0.00	0.00%	33.00	2,129.49	100.00%
03.10.03	BISAGRA CAPUCHINA DE 3"	pca	235.00	12.35	2,902.25	0.0000	0.00	0.00%		0.00	0.00%	0.00	0.00	0.00%	235.00	2,902.25	100.00%
03.11	PINTURA					0.0000											
03.11.01	PINTURA EN MUROS Y COLUMNAS INTERIORES CON EPOXICO	m2	1,892.61	18.51	35,032.21	0.0000	0.00	0.00%		0.00	0.00%	0.00	0.00	0.00%	1,892.61	35,032.21	100.00%
03.11.02	PINTURA EN MUROS Y COLUMNAS INTERIORES CON LATEX	m2	843.02	16.40	13,825.63	0.0000	0.00	0.00%	73.81	1,210.51	8.76%	73.81	1,210.51	8.76%	769.21	12,615.02	91.24%
03.11.03	PINTURA EN PISO CON EPOXICO	m2	868.73	19.38	16,835.99	0.0000	0.00	0.00%		0.00	0.00%	0.00	0.00	0.00%	868.73	16,835.99	100.00%
03.11.04	PINTURA EN MUROS, COLUMNAS Y VIGAS EXTERIORES CON	m2	3,183.98	16.91	53,841.10	0.0000	0.00	0.00%		0.00	0.00%	0.00	0.00	0.00%			
03.11.05	PINTURA EN CIELO RASO CON EPOXICO	m2	879.29	20.73	18,227.68	0.0000	0.00	0.00%	44.78	757.15	1.41%	44.78	757.15	1.41%	3,139.21	53,083.96	98.59%
03.11.06	PINTURA EN CIELO RASO CON LATEX	m2	880.80	18.62	16,400.50	0.0000	0.00	0.00%		0.00	0.00%	0.00	0.00	0.00%	879.29	18,227.68	100.00%
03.12	OTROS					0.0000											
03.12.01	CORTINA DE TRASLAPE DE PVC (PROVISION Y COLOCACIÓN)	m2	59.52	61.95	3,687.26	0.0000	0.00	0.00%		0.00	0.00%	0.00	0.00	0.00%	59.52	3,687.26	100.00%
03.12.02	PROTECCION DE MADERA DE BORDE DE PLATRAFORMA	m	29.40	165.81	4,874.81	0.0000	0.00	0.00%		0.00	0.00%	0.00	0.00	0.00%	29.40	4,874.81	100.00%
	COSTO DIRECTO				1,420,041.02		469,200.24			55,566.32	3.91%		524,766.55	36.95%		895,274.44	63.05%
	GASTOS GENERALES		20.083931%		285,200.06		94,233.85			11,159.90			105,393.75			179,806.30	
	UTILIDAD		232247929%		32,980.16		10,897.08			1,290.52			12,187.60			20,792.56	
	SUB TOTAL				1,738,221.23		574,331.16			68,016.74			642,347.90			1,095,873.30	
	IGV 18%		18.00%		312,879.82		103,379.61			12,243.01			115,622.62			192,257.19	
	PRESUPUESTO TOTAL				2,051,101.06		677,710.77			80,259.75			757,970.52			1,293,130.50	

CONSORCIO MARITIMO DEL NORTE
 DESEMBARCADERO ARTESANAL DE SUPE
 DANIEL JOAQUIN MORALES VIVANCO
 RESIDENTE DE OBRA
 REG. CIP N° 98098

000315



VALORIZACIÓN N° 12 DEL 01 AL 31 DE AGOSTO DEL 2018
(PRECIOS UNITARIOS)

Contrato N° 025-2017- FONDEPES Ejecución de la Obra: MEJORAMIENTO DE
LOS SERVICIOS DEL DESEMBARCADERO PESQUERO ARTESANAL DE
SUPE, REGION LIMA, PROVINCIA DE BARRANCA, DISTRITO DE SUPE PUERTO



OBRA: MEJORAMIENTO DE LOS SERVICIOS DEL DESEMBARCADERO PESQUERO ARTESANAL DE SUPE .REGION LIMA, PROVINCIA DE BARRANCA, DISTRITO DE SUPE PUERTO
SUB PRES: INSTALACIONES SANITARIAS
PROP: FONDEPES
CONT: CONSORCIO MARITIMO DEL NORTE
SUP: CESEL

FECHA: mar 02 Oct 2016

ITEM	DESCRIPCION	PRESUPUESTO			VAL. ACUM. ANTERIOR			VAL. ACTUAL			VAL. ACUM. ACTUAL			SALDOS			
		Und.	Metrado	Precio (S/.)	Parcial (S/.)	Metrado	Parcial (S/.)	%	Metrado	Parcial (S/.)	%	Metrado	Parcial (S/.)	%	Metrado	Parcial (S/.)	%
05	INSTALACIONES SANITARIAS																
05.01	RED DE AGUA POTABLE																
05.01.01	RED DE DISTRIBUCION																
05.01.01.01	TRAZO Y REPLANTEO DE RED	m	658.40	3.64	2,396.58	130.4600	S/ 474.87	19.81%	0.00	S/ -	0.00%	130.4600	S/ 474.87	19.81%	527.9400	1,921.71	80.19%
05.01.01.02	EXCAVACION DE ZANJA P/TUBERIA	m	642.40	35.88	23,049.31	62.7100	S/ 2,250.03	9.76%	0.00	S/ -	0.00%	62.7100	S/ 2,250.03	9.76%	579.6900	20,799.28	90.24%
05.01.01.03	REFINE Y NIVELACION DE ZANJAS	m	642.40	5.26	3,379.02	82.5600	S/ 434.27	12.85%	0.00	S/ -	0.00%	82.5600	S/ 434.27	12.85%	559.8400	2,944.75	87.15%
05.01.01.04	PREP. D/CAMA DE APOYO (E=10cm)	m	642.40	20.70	13,297.68	82.5600	S/ 1,708.99	12.85%	0.00	S/ -	0.00%	82.5600	S/ 1,708.99	12.85%	559.8400	11,588.69	87.15%
05.01.01.05	RELL. COMP. C.PL VIBRADOR/MANUAL E/T, N	m	642.40	16.30	10,471.12	87.1900	S/ 1,421.20	13.57%	0.00	S/ -	0.00%	87.1900	S/ 1,421.20	13.57%	555.2100	9,049.92	86.43%
05.01.02	SALIDAS																
05.01.02.01	SALIDA DE AGUA FRIA CON TUBERIA PVC SAP 1/2"	pie	71.00	87.23	6,193.33	71.0000	S/ 6,193.33	100.00%	0.00	S/ -	0.00%	71.0000	S/ 6,193.33	100.00%	0.0000	0.00	0.00%
05.01.02.02	SALIDA DE AGUA FRIA CON TUBERIA PVC SAP 3/4"	pie	8.00	94.42	755.36	0.0000	S/ -	0.00%	0.00	S/ -	0.00%	0.0000	S/ -	0.00%	8.0000	755.36	100.00%
05.01.03	VALVULAS																
05.01.03.01	VALVULA COMPUERTA DE BRONCE DE UNION ROSCADA DE 3/4"	und	18.00	46.70	840.60	0.0000	S/ -	0.00%	0.00	S/ -	0.00%	0.0000	S/ -	0.00%	18.0000	840.60	100.00%
05.01.04	TUBERIAS																
05.01.04.01	SUM. /INST. T/PRUEBA HIDRA/TUB PVC D=1/2" C-5	m	174.65	13.36	2,333.32	0.0000	S/ -	0.00%	0.00	S/ -	0.00%	0.0000	S/ -	0.00%	174.6500	2,333.32	100.00%
05.01.04.02	SUM. /INST. T/PRUEBA HIDRA/TUB PVC D=3/4" C-5	m	145.05	16.33	2,368.67	0.0000	S/ -	0.00%	0.00	S/ -	0.00%	0.0000	S/ -	0.00%	145.0500	2,368.67	100.00%
05.01.04.03	SUM. /INST. T/PRUEBA HIDRA/TUB PVC D=1" C-5	m	13.85	20.55	284.62	0.0000	S/ -	0.00%	0.00	S/ -	0.00%	0.0000	S/ -	0.00%	13.8500	284.62	100.00%
05.01.04.04	SUM. /INST. T/PRUEBA HIDRA/TUB PVC D=1 1/2" C-5	m	95.85	22.09	2,117.33	0.0000	S/ -	0.00%	0.00	S/ -	0.00%	0.0000	S/ -	0.00%	95.8500	2,117.33	100.00%
05.01.04.05	SUM. /INST. T/PRUEBA HIDRA/TUB PVC D=2" C-5	m	88.00	22.14	1,948.32	0.0000	S/ -	0.00%	0.00	S/ -	0.00%	0.0000	S/ -	0.00%	88.0000	1,948.32	100.00%
05.01.05	VARIOS																
05.01.05.01	NICHO Y TAPA DE MADERA PARA VALVULA EN PARED	und	18.00	60.20	1,083.60	0.0000	S/ -	0.00%	0.00	S/ -	0.00%	0.0000	S/ -	0.00%	18.0000	1,083.60	100.00%
05.01.06	ACCESORIOS																
05.01.06.01	VALVULA Y ACCESORIOS PARA CISTERNA Y TANQUE	und	2.00	1,224.52	2,449.04	0.0000	S/ -	0.00%	0.00	S/ -	0.00%	0.0000	S/ -	0.00%	2.0000	2,449.04	100.00%
05.01.07	PRUEBA HIDRAULICA																
05.01.07.01	PRUEBA HIDRAULICA PARA TUBERIA DE AGUA FRIA	m	562.00	6.86	3,855.32	107.4800	S/ 737.31	19.12%	0.00	S/ -	0.00%	107.4800	S/ 737.31	19.12%	454.5200	3,118.01	80.88%
05.01.08	EQUIPO DE BOMBEO																
05.01.08.01	ADQUISICION /INST. /02 ELECTROBOMBAS	und	2.00	4,431.81	8,863.62	0.0000	S/ -	0.00%	0.00	S/ -	0.00%	0.0000	S/ -	0.00%	2.0000	8,863.62	100.00%
05.01.08.02	ACCESORIOS PARA CASETA T/ELEVADO	und	1.00	1,076.21	1,076.21	0.0000	S/ -	0.00%	0.00	S/ -	0.00%	0.0000	S/ -	0.00%	1.0000	1,076.21	100.00%
05.01.08.03	ACCESORIOS PARA LA BOMBA	und	2.00	1,385.84	2,771.68	0.0000	S/ -	0.00%	0.00	S/ -	0.00%	0.0000	S/ -	0.00%	2.0000	2,771.68	100.00%
05.01.09	LINEA DE IMPULSION																
05.01.09.01	TUBERIA FIERRO GALVANIZADO AGUA FRIA D=2"	m	32.75	60.81	1,991.53	0.0000	S/ -	0.00%	0.00	S/ -	0.00%	0.0000	S/ -	0.00%	32.7500	1,991.53	100.00%
05.01.10	PUESTA A SERVICIO																
05.01.10.01	CONEXION DE AGUA POTABLE	est	1.00	1,296.00	1,296.00	0.0000	S/ -	0.00%	0.00	S/ -	0.00%	0.0000	S/ -	0.00%	1.0000	1,296.00	100.00%
05.02	RED DE ALCANTARILLADO																
05.02.01	SANEAMIENTO																
05.02.01.01	EXCAVACION DE ZANJA P/TUBERIA	m	55.54	35.88	1,992.78	55.5400	S/ 1,992.78	100.00%	0.00	S/ -	0.00%	55.5400	S/ 1,992.78	100.00%	0.0000	0.00%	100.00%
05.02.01.02	REFINE Y NIVELACION DE ZANJAS	m	55.54	5.26	292.14	55.5400	S/ 292.14	100.00%	0.00	S/ -	0.00%	55.5400	S/ 292.14	100.00%	0.0000	0.00%	100.00%
05.02.01.03	PREP. D/CAMA DE APOYO (E=10cm)	m	55.54	20.70	1,149.68	55.5400	S/ 1,149.68	100.00%	0.00	S/ -	0.00%	55.5400	S/ 1,149.68	100.00%	0.0000	0.00%	100.00%
05.02.01.04	RELL. COMP. C.PL VIBRADOR/MANUAL E/T, N	m	55.54	16.30	905.30	55.5400	S/ 905.30	100.00%	0.00	S/ -	0.00%	55.5400	S/ 905.30	100.00%	0.0000	0.00%	100.00%
05.02.01.05	ELIMINACION DE MATERIAL EXCEDENTE EXCAV. ZANJAS	m3	15.33	12.99	199.14	15.3300	S/ 199.14	100.00%	0.00	S/ -	0.00%	15.3300	S/ 199.14	100.00%	0.0000	0.00%	100.00%
05.02.02	CAJA DE REGISTRO																
05.02.02.01	CAJA DE REGISTRO DE 12"X24"	und	15.00	216.35	3,245.25	6.0000	S/ 1,298.10	40.00%	3.00	S/ 649.05	20.00%	9.0000	S/ 1,947.15	60.00%	6.0000	1,298.10	40.00%
05.02.02.02	CAJA DE REGISTRO DE 24"X24"	und	1.00	263.77	263.77	0.0000	S/ -	0.00%	0.00	S/ -	0.00%	0.0000	S/ -	0.00%	1.0000	263.77	100.00%
05.02.03	BUZONES DE INSPECCION																
05.02.03.01	CONSTRUCCION DE BUZON H=1.50m	und	1.00	2,146.96	2,146.96	0.0000	S/ -	0.00%	0.00	S/ -	0.00%	0.0000	S/ -	0.00%	1.0000	2,146.96	100.00%
05.02.04	TUBERIAS																

CONSORCIO MARITIMO DEL NORTE
DESEMBARCADERO ARTESANAL DE SUPE
DANIEL JOAQUIN MORALES VIVANCO
RESIDENTE DE OBRA
REG. CIP. N° 98098



VALORIZACIÓN N° 12 DEL 01 AL 31 DE AGOSTO DEL 2018
(PRECIOS UNITARIOS)

Contrato N° 025-2017- FONDEPES Ejecucion de la Obra: MEJORAMIENTO DE LOS SERVICIOS DEL DESEMBARCADERO PESQUERO ARTESANAL DE SUPE, REGION LIMA, PROVINCIA DE BARRANCA, DISTRITO DE SUPE PUERTO



OBRA: MEJORAMIENTO DE LOS SERVICIOS DEL DESEMBARCADERO PESQUERO ARTESANAL DE SUPE .REGION LIMA, PROVINCIA DE BARRANCA, DISTRITO DE SUPE PUERTO
SUB PRES: INSTALACIONES SANITARIAS
PROP: FONDEPES
CONT: CONSORCIO MARITIMO DEL NORTE
SUP: CESEL

FECHA: mar 02 Oct 2018

ITEM	DESCRIPCION	PRESUPUESTO			VAL. ACUM. ANTERIOR			VAL. ACTUAL			VAL. ACUM. ACTUAL			SALDOS			
		Und.	Metrado	Preco (S/.)	Parcial (S/.)	Metrado	Parcial (S/.)	%	Metrado	Parcial (S/.)	%	Metrado	Parcial (S/.)	%	Metrado	Parcial (S/.)	%
05.02.04.01	INSTALACION DE TUBERIA PVC SAL D=2"	m	169.65	7.01	1,189.25	0.0000	S/ -	0.00%	0.00	S/ -	0.00%	0.0000	S/ -	0.00%	169.6500	1,189.25	100.00%
05.02.04.02	INSTALACION DE TUBERIA PVC SAL D=4"	m	115.05	11.40	1,311.57	0.0000	S/ -	0.00%	0.00	S/ -	0.00%	0.0000	S/ -	0.00%	115.0500	1,311.57	100.00%
05.02.04.03	INSTALACION DE VENTILACION PVC D=6"	m	150.15	29.75	4,466.96	0.0000	S/ -	0.00%	0.00	S/ -	0.00%	0.0000	S/ -	0.00%	150.1500	4,466.96	100.00%
05.02.05	SALIDAS DE DESAGUE Y VENTILACION																
05.02.05.01	SALIDA DE DESAGUE PVC SAL 2"	pto	57.00	16.54	942.78	52.0000	S/ 860.08	91.23%	0.00	S/ -	0.00%	52.0000	S/ 860.08	91.23%	5.0000	82.70	8.77%
05.02.05.02	SALIDA DE DESAGUE PVC SAL 4"	pto	17.00	22.27	378.59	17.0000	S/ 378.59	100.00%	0.00	S/ -	0.00%	17.0000	S/ 378.59	100.00%	0.0000	0.00	0.00%
05.02.05.03	SALIDA DE VENTILACION PVC SAL D=2"	pto	6.00	64.64	387.84	6.0000	S/ 387.84	100.00%	0.00	S/ -	0.00%	6.0000	S/ 387.84	100.00%	0.0000	0.00	0.00%
05.02.05.04	SALIDA DE BAJADA DE LLUVIA PVC SAL D=3"	pto	15.00	86.33	1,294.95	0.0000	S/ -	0.00%	0.00	S/ -	0.00%	0.0000	S/ -	0.00%	15.0000	1,294.95	100.00%
05.02.06	ADITAMENTOS VARIOS																
05.02.06.01	ACCESORIOS PARA DESAGUE	und	1.00	965.86	965.86	0.5000	S/ 482.93	50.00%	0.00	S/ -	0.00%	0.5000	S/ 482.93	50.00%	0.5000	482.93	50.00%
05.02.07	REGISTROS																
05.02.07.01	REGISTRO DE BRONCE DE 2"	und	2.00	41.17	82.34	2.0000	S/ 82.34	100.00%	0.00	S/ -	0.00%	2.0000	S/ 82.34	100.00%	0.0000	0.00	0.00%
05.02.07.02	REGISTRO DE BRONCE DE 4"	und	22.00	32.26	709.72	2.0000	S/ 64.52	9.09%	0.00	S/ -	0.00%	2.0000	S/ 64.52	9.09%	20.0000	645.20	90.91%
05.02.08	SUMINEROS																
05.02.08.01	SUMIDERO DE 2"	und	23.00	37.67	866.41	14.0000	S/ 527.38	60.87%	0.00	S/ -	0.00%	14.0000	S/ 527.38	60.87%	9.0000	339.03	39.13%
05.02.09	CAMARA DE BOMBEO, CUARTO DE BOMBAS																
05.02.09.01	SUMINISTRO E INSTALACION DE EQUIPO DE BOMBEO	und	2.00	4,705.84	9,411.68	0.0000	S/ -	0.00%	0.00	S/ -	0.00%	0.0000	S/ -	0.00%	2.0000	9,411.68	100.00%
05.02.09.02	ACCESORIOS PARA BOMBAS SUMERGIBLES	und	1.00	1,385.84	1,385.84	0.0000	S/ -	0.00%	0.00	S/ -	0.00%	0.0000	S/ -	0.00%	1.0000	1,385.84	100.00%
05.02.09.03	ACCESORIOS PARA CASETA DE BOMBEO	und	1.00	1,164.49	1,164.49	0.0000	S/ -	0.00%	0.00	S/ -	0.00%	0.0000	S/ -	0.00%	1.0000	1,164.49	100.00%
05.02.09.04	CONSTRUCCION DE CASETA DE BOMBAS	und	1.00	8,273.24	8,273.24	0.0000	S/ -	0.00%	0.00	S/ -	0.00%	0.0000	S/ -	0.00%	1.0000	8,273.24	100.00%
05.02.10	LINEA DE IMPULSION																
05.02.10.01	SUM. /INST. T/PRUEBA HIDRA/TUB PVC D=2" C-10	m	20.00	33.76	675.20	0.0000	S/ -	0.00%	0.00	S/ -	0.00%	0.0000	S/ -	0.00%	20.0000	675.20	100.00%
05.02.11	PRUEBA DE NIVELACION																
05.02.11.01	PRUEBA DE NIVELACION P/DESAGUE	m	549.15	3.91	2,147.18	104.7000	S/ 409.38	19.07%	0.00	S/ -	0.00%	104.7000	S/ 409.38	19.07%	444.4500	1,737.80	80.93%
05.02.12	PRUEBA HIDRAULICA																
05.02.12.01	PRUEBA HIDRAULICA P/DESAGUE	m	549.15	3.91	2,147.18	137.3500	S/ 537.04	25.01%	0.00	S/ -	0.00%	137.3500	S/ 537.04	25.01%	411.8000	1,610.14	74.99%
05.02.13	TRAMPA DE GRASAS																
05.02.13.01	TRAMPA DE GRASAS Y SOLIDOS	und	1.00	1,300.18	1,300.18	0.0000	S/ -	0.00%	0.00	S/ -	0.00%	0.0000	S/ -	0.00%	1.0000	1,300.18	100.00%
05.02.14	CANALETAS																
05.02.14.01	EXCAVACION DE CANALETAS	m	204.00	35.32	7,205.28	0.0000	S/ -	0.00%	0.00	S/ -	0.00%	0.0000	S/ -	0.00%	204.0000	7,205.28	100.00%
05.02.14.02	ENCOFRADO DE CANALETAS	m2	326.40	116.10	37,895.04	0.0000	S/ -	0.00%	0.00	S/ -	0.00%	0.0000	S/ -	0.00%	326.4000	37,895.04	100.00%
05.02.14.03	CONCRETO Fc=210 kg/cm2 EN CANALETAS	m3	23.04	386.99	8,916.25	0.0000	S/ -	0.00%	0.00	S/ -	0.00%	0.0000	S/ -	0.00%	23.0400	8,916.25	100.00%
05.02.14.04	COLOCACION DE REJILLA EN CANALETAS DE FIBRA DE VIDRIO	m2	76.80	294.78	22,639.10	0.0000	S/ -	0.00%	0.00	S/ -	0.00%	0.0000	S/ -	0.00%	76.8000	22,639.10	100.00%
05.03	RED DE AGUA DE MAR																
05.03.01	CASETA DE CAPTACION																
05.03.01.01	ACCESORIOS PARA EQUIPO DE SUCCION	und	1.00	3,690.94	3,690.94	0.0000	S/ -	0.00%	0.00	S/ -	0.00%	0.0000	S/ -	0.00%	1.0000	3,690.94	100.00%
05.03.02	EQUIPO DE BOMBEO A CISTERNA																
05.03.02.01	ADQUISICION /INST. /02 ELECTROBOMBAS Q=6.5LT P=2.5HP	und	2.00	5,305.62	10,611.24	0.0000	S/ -	0.00%	0.00	S/ -	0.00%	0.0000	S/ -	0.00%	2.0000	10,611.24	100.00%
05.03.02.02	ACCESORIOS PARA LA BOMBA	und	1.00	1,385.84	1,385.84	0.0000	S/ -	0.00%	0.00	S/ -	0.00%	0.0000	S/ -	0.00%	1.0000	1,385.84	100.00%
05.03.03	SISTEMA DE FILTRADO Y DESINFECCION																
05.03.03.01	EQUIPO DE FILTRADO Y DESINFECCION	und	2.00	5,250.48	10,500.96	0.0000	S/ -	0.00%	0.00	S/ -	0.00%	0.0000	S/ -	0.00%	2.0000	10,500.96	100.00%
05.03.03.02	ACCESORIOS PARA EL SISTEMA DE FILTRADO	und	1.00	1,978.25	1,978.25	0.0000	S/ -	0.00%	0.00	S/ -	0.00%	0.0000	S/ -	0.00%	1.0000	1,978.25	100.00%
05.03.04	LINEA DE IMPULSION A CISTERNA																
05.03.04.01	EXCAVACION DE ZANJA P/TUBERIA	m	42.25	35.88	1,515.93	7.6700	S/ 275.20	18.15%	0.00	S/ -	0.00%	7.6700	S/ 275.20	18.15%	3.5900	1,240.73	81.85%
05.03.04.02	REFINE Y NIVELACION DE ZANJAS	m	42.50	5.26	223.55	0.0000	S/ -	0.00%	0.00	S/ -	0.00%	0.0000	S/ -	0.00%	42.5000	223.55	100.00%
05.03.04.03	PREP. D/CAMA DE APOYO (E=10cm)	m	42.50	20.70	879.75	0.0000	S/ -	0.00%	0.00	S/ -	0.00%	0.0000	S/ -	0.00%	42.5000	879.75	100.00%
05.03.04.04	RELL. COMP. C.PL VIBRADOR/MANUAL E/T. N	m	42.50	16.30	692.75	4.6020	S/ 75.01	10.83%	0.00	S/ -	0.00%	4.6020	S/ 75.01	10.83%	37.8980	617.74	89.17%
05.03.04.05	SUM. /INST. T/PRUEBA HIDRA/TUB PVC D=2 1/2" C-10	m	273.98	23.30	6,383.73	0.0000	S/ -	0.00%	0.00	S/ -	0.00%	0.0000	S/ -	0.00%	273.9800	6,383.73	100.00%

CONSORCIO MARITIMO DEL NORTE
DESEMBARCADERO ARTESANAL DE SUPE
DANIEL JOAQUIN MORALES VIVANCO
RESIDENTE DE GUARA
REG. CIP. N° 98088

OBRA: MEJORAMIENTO DE LOS SERVICIOS DEL DESEMBARCADERO PESQUERO ARTESANAL DE SUPE .REGION LIMA, PROVINCIA DE BARRANCA, DISTRITO DE SUPE PUERTO
SUB PRES: INSTALACIONES SANITARIAS
PROP: FONDEPES
CONT: CONSORCIO MARITIMO DEL NORTE
SUP: CESEL

FECHA: mar 02 Oct 2018

ITEM	DESCRIPCION	PRESUPUESTO			VAL. ACUM. ANTERIOR			VAL. ACTUAL			VAL. ACUM. ACTUAL			SALDOS				
		Und.	Metrado	Precio (S/.)	Parcial (S/.)	Metrado	Parcial (S/.)	%	Metrado	Parcial (S/.)	%	Metrado	Parcial (S/.)	%	Metrado	Parcial (S/.)	%	
05.04.07.04	SUMINISTRO DE ACCESORIOS DE TUBERIA HDPE LASTRE DE	m	1.00	3,783.24	3,783.24	0.0000	S/ -	0.00%	0.00	S/ -	0.00%	0.0000	S/ -	0.00%	1.0000	3,783.24	100.00%	
05.04.07.05	LASTRE DE CONCRETO DE 50KG APROX. TIPO 2 SEPARACION	nd	500.00	162.54	81,270.00	0.0000	S/ -	0.00%	0.00	S/ -	0.00%	0.0000	S/ -	0.00%	500.0000	81,270.00	100.00%	
05.04.07.06	LASTRE DE CONCRETO DE 50KG APROX. TIPO 2 SEPARACION	nd	10.00	162.54	1,625.40	0.0000	S/ -	0.00%	0.00	S/ -	0.00%	0.0000	S/ -	0.00%	10.0000	1,625.40	100.00%	
05.04.08	TERMOFUSION																	
05.04.08.01	SERVICIOS DE TERMOFUSION DE TUBERIAS DE 160MM PN-10	p	1.00	9,639.27	9,639.27	0.0000	S/ -	0.00%	0.00	S/ -	0.00%	0.0000	S/ -	0.00%	1.0000	9,639.27	100.00%	
05.04.09	ULTRASONIDO- CONTROL DE CALIDAD																	
05.04.09.01	INSPECCION ULTRASONICA DE JUNTA	p	1.00	7,005.77	7,005.77	0.0000	S/ -	0.00%	0.00	S/ -	0.00%	0.0000	S/ -	0.00%	1.0000	7,005.77	100.00%	
05.04.10	LANZAMIENTO Y HUNDIMIENTO																	
05.04.10.01	LANZAMIENTO Y HUNDIMIENTO DE LINEA	p	1.00	15,828.55	15,828.55	0.0000	S/ -	0.00%	0.00	S/ -	0.00%	0.0000	S/ -	0.00%	1.0000	15,828.55	100.00%	
05.04.10.02	FIJACION PRIMEROS METROS DE TUBERIA CONCRETO	p	8.00	903.86	7,230.88	0.0000	S/ -	0.00%	0.00	S/ -	0.00%	0.0000	S/ -	0.00%	8.0000	7,230.88	100.00%	
05.04.10.03	PRUEBAS Y PUESTA EN MARCHA DE EMISOR SUBMARINO	p	1.00	11,398.52	11,398.52	0.0000	S/ -	0.00%	0.00	S/ -	0.00%	0.0000	S/ -	0.00%	1.0000	11,398.52	100.00%	
05.05	APARATOS Y ACCESORIOS SANITARIOS																	
05.05.01	APARATOS SANITARIOS																	
05.05.01.01	INODORO COLOR BLANCO CON ASIEN TO	nd	18.00	356.80	6,422.40	0.0000	S/ -	0.00%	0.00	S/ -	0.00%	0.0000	S/ -	0.00%	18.0000	6,422.40	100.00%	
05.05.01.02	URINARIO	nd	7.00	406.29	2,844.03	0.0000	S/ -	0.00%	0.00	S/ -	0.00%	0.0000	S/ -	0.00%	7.0000	2,844.03	100.00%	
05.05.02	LAVATORIOS																	
05.05.02.01	LAVATORIO DE PARED	nd	19.00	203.51	3,866.69	0.0000	S/ -	0.00%	0.00	S/ -	0.00%	0.0000	S/ -	0.00%	19.0000	3,866.69	100.00%	
05.05.02.02	LAVADERO DE COCINA DE ACERO INOXIDABLE	nd	2.00	432.79	865.58	0.0000	S/ -	0.00%	0.00	S/ -	0.00%	0.0000	S/ -	0.00%	2.0000	865.58	100.00%	
05.05.02.03	DUCHA CROMADA DE CABEZA GIRATORIA Y LLAVE	nd	9.00	241.54	2,173.86	0.0000	S/ -	0.00%	0.00	S/ -	0.00%	0.0000	S/ -	0.00%	9.0000	2,173.86	100.00%	
05.05.02.04	GRIFERIA PARA LAVADERO	nd	19.00	221.35	4,205.65	0.0000	S/ -	0.00%	0.00	S/ -	0.00%	0.0000	S/ -	0.00%	19.0000	4,205.65	100.00%	
05.05.02.05	PAPELERA CON EJE ADHESIVO C/SILICONA BLANCO	nd	18.00	155.82	2,804.76	0.0000	S/ -	0.00%	0.00	S/ -	0.00%	0.0000	S/ -	0.00%	18.0000	2,804.76	100.00%	
05.05.02.06	TOALLERO DE BARRA	nd	9.00	161.37	1,452.33	0.0000	S/ -	0.00%	0.00	S/ -	0.00%	0.0000	S/ -	0.00%	9.0000	1,452.33	100.00%	
05.05.02.07	MANILUVIOS/GRIFOS	nd	2.00	325.94	651.88	0.0000	S/ -	0.00%	0.00	S/ -	0.00%	0.0000	S/ -	0.00%	2.0000	651.88	100.00%	
	COSTO DIRECTO				670,659.81			94,649.88			769.45			95,419.33	14.23%		575,240.47	85.77%
	GASTOS GENERALES				134,694.85			19,009.42			154.54			19,163.96			115,530.90	
	UTILIDAD				15,575.94			2,198.22			17.87			2,216.09			13,359.84	
	SUB TOTAL				820,930.60			115,857.52			941.86			116,799.38			704,131.21	
	IGV 18%		18.00%		147,767.51			20,854.35			169.53			21,023.89			126,743.62	
	PRESUPUESTO TOTAL				968,698.10			136,711.87			1,111.39			137,823.27			830,874.83	

CONSORCIO MARITIMO DEL NORTE
DESEMBARCADERO ARTESANAL DE SUPE

DANIEL JOAQUIN MORALES VIVAS
RESIDENTE DE OBRA
REG. CIP N° 98098

000301



VALORIZACIÓN Nº 18 DEL 01 AL 28 DE FEBRERO DE 2019 (PRECIOS UNITARIOS)

Contrato Nº 025-2017- FONDEPES Ejecución de la Obra: MEJORAMIENTO DE LOS SERVICIOS DEL DESEMBARCADERO PESQUERO ARTESANAL DE SUPE, REGION LIMA, PROVINCIA DE BARRANCA, DISTRITO DE SUPE PUERTO



OBRA: MEJORAMIENTO DE LOS SERVICIOS DEL DESEMBARCADERO PESQUERO ARTESANAL DE SUPE, REGION LIMA, PROVINCIA DE BARRANCA, DISTRITO DE SUPE PUERTO
SUB PRES: OBRAS EN TIERRA - EQUIPAMIENTO
PROP: FONDEPES
CONT: CONSORCIO MARITIMO DEL NORTE
SUP: CESEL

FECHA: má 27 Feb 2019

Table with columns: ITEM, DESCRIPCION, PRESUPUESTO (Und, Metrado, Precio (\$/.), Parcial (\$/.)), VAL. ACUM. ANTERIOR (Metrado, Parcial (\$/.), %), VAL. ACTUAL (Metrado, Parcial (\$/.), %), VAL. ACUM. ACTUAL (Metrado, Parcial (\$/.), %), SALDOS (Metrado, Parcial (\$/.), %). Includes sub-totals for COSTO DIRECTO, GASTOS GENERALES, UTILIDAD, SUB TOTAL, IGV 18%, and PRESUPUESTO TOTAL.

CONSORCIO MARITIMO DEL NORTE
DESEMBARCADERO ARTESANAL DE SUPE
DANIEL JOAQUIN MORALES VIVANCO
RESIDENTE DE OBRA
REG. CHP Nº 98098

000350



VALORIZACIÓN N° 18 DEL 01 AL 28 DE FEBRERO DE 2019
(PRECIOS UNITARIOS)

Contrato N° 025-2017- FONDEPES Ejecución de la Obra:
MEJORAMIENTO DE LOS SERVICIOS DEL DESEMBARCADERO
PESQUERO ARTESANAL DE SUPE, REGION LIMA, PROVINCIA DE
BARRANCA, DISTRITO DE SUPE PUERTO



OBRA: MEJORAMIENTO DE LOS SERVICIOS DEL DESEMBARCADERO PESQUERO ARTESANAL DE SUPE, REGION LIMA, PROVINCIA DE BARRANCA, DISTRITO DE SUPE PUERTO
SUB PRES IMPACTO AMBIENTAL
PROP. FONDEPES
CONT. CONSORCIO MARITIMO DEL NORTE
SUP. CESEL

FECHA: mié 27 Feb 2019

ITEM	DESCRIPCION	PRESUPUESTO				VAL. ACUM. ANTERIOR			VAL. ACTUAL			VAL. ACUM. ACTUAL			SALDO		
		Und.	Metrado	Precio (S/.)	Parcial (S/.)	Metrado	Parcial (S/.)	%	Metrado	Parcial (S/.)	%	Metrado	Parcial (S/.)	%	Metrado	Parcial (S/.)	%
07	IMPACTO AMBIENTAL																
07.01	MANEJO DE RESIDUOS SOLIDOS Y EFLUENTES																
07.01.2001	SUMINISTRO E INSTALACION DE CONTENEDOR DE BASURA	und	20.00	S/ 243.59	S/ 4,871.80	19.50	S/ 4,750.01	97.50%	0.00	0.00	0.00%	19.50	S/4,750.01	97.50%	0.50	121.80	2.50%
07.01.2002	AREA DE ALMACENAMIENTO TEMPORAL	glb	1.00	S/ 1,328.71	S/ 1,328.71	1	S/ 1,328.71	100.00%	0.00	0.00	0.00%	1	S/1,328.71	100.00%	0.00	0.00	0.00%
07.01.2003	CILINDRO METALICOS PARA ALMACENAMIENTO DE EFLUENTES INDUSTRIALES	und	5.00	S/ 422.87	S/ 2,114.35	5.00	S/ 2,114.35	100.00%	0.00	0.00	0.00%	5.00	S/2,114.35	100.00%	0.00	0.00	0.00%
07.01.2004	ALQUILER BAÑOS QUIMICOS 8 UNIDADES INC. INSTALACION Y OPERACION	mes	9.00	S/ 910.19	S/ 8,191.71	9	S/ 8,191.71	100.00%	0.00	0.00	0.00%	9	S/8,191.71	100.00%	0.00	0.00	0.00%
07.01.2005	TRANSPORTE Y DISPOSICION DE RESIDUOS PELIGROSOS	und	9.00	S/ 348.84	S/ 3,139.56	8.00	S/ 2,790.72	88.89%	0.00	0.00	0.00%	8.00	S/2,790.72	88.89%	1.00	348.84	11.11%
07.02	SEÑALIZACION AMBIENTAL Y SEGURIDAD																
07.02.2001	SEÑALIZACION TEMPORAL	und	30.00	S/ 65.45	S/ 1,963.50	30.00	S/ 1,963.50	100.00%	0.00	0.00	0.00%	30.00	S/1,963.50	100.00%	0.00	0.00	0.00%
07.02.2002	SEÑALIZACION PERMANENTE	und	20.00	S/ 100.69	S/ 2,013.80	20	S/ 2,013.80	100.00%	0.00	0.00	0.00%	20.00	S/2,013.80	100.00%	0.00	0.00	0.00%
07.03	CAPACITACION EN TEMAS AMBIENTALES Y SEGURIDAD																
07.03.2001	CHARLA DE SEGURIDAD EN OBRA PARA PERSONAL	und	9.00	S/ 232.56	S/ 2,093.04	9.00	S/ 2,093.04	100.00%	0.00	0.00	0.00%	9.00	S/2,093.04	100.00%	0.00	0.00	0.00%
07.03.2002	CHARLA SOBRE TEMAS AMBIENTALES - PESCADORES	und	2.00	S/ 872.09	S/ 1,744.18	1.4	S/ 1,220.93	70.00%	0.00	0.00	0.00%	1.4	S/1,220.93	70.00%	0.60	523.25	30.00%
07.04	MITIGACION IMPACTOS EN MEDIO AMBIENTE																
07.04.2001	SERV. MONITOREO AMBIENTAL, CALIDAD AIRE, AGUA, RUIDO	und	1.00	S/ 1,395.34	S/ 1,395.34	0.50	S/ 697.67	50.00%	0.00	0.00	0.00%	0.50	S/697.67	50.00%	0.50	697.67	50.00%
07.04.2002	MEDIDAS MITIGACION EMISION DE POLVO	glb	1.00	S/ 2,906.96	S/ 2,906.96	0.25	S/ 726.74	25.00%	0.00	0.00	0.00%	0.25	S/726.74	25.00%	0.75	2,180.22	75.00%
07.04.2003	MEDIDAS MITIGACION RUIDO	und	1.00	S/ 2,768.48	S/ 2,768.48	0.25	S/ 692.12	25.00%	0.00	0.00	0.00%	0.25	S/692.12	25.00%	0.75	2,076.36	75.00%
07.04.2004	MEDIDAS MITIGACION CONTAMINACION DE AGUA	glb	1.00	S/ 2,844.34	S/ 2,844.34	0.25	S/ 711.09	25.00%	0.00	0.00	0.00%	0.25	S/711.09	25.00%	0.75	2,133.26	75.00%
07.05	PROGRAMA DE CONTINGENCIAS																
07.05.2001	PRIMEROS AUXILIOS	glb	1.00	S/ 1,744.18	S/ 1,744.18	0.50	S/ 872.09	50.00%	0.00	0.00	0.00%	0.50	S/872.09	50.00%	0.50	872.09	50.00%
07.05.2002	CONTRA INCENDIO	est	1.00	S/ 1,860.44	S/ 1,860.44	0.50	S/ 930.22	50.00%	0.00	0.00	0.00%	0.50	S/930.22	50.00%	0.50	930.22	50.00%
07.06	PROGRAMA DE CIERRE DE OBRA																
07.06.2001	DESMANTELAMIENTO DE ESTRUCTURAS TEMPORALES	glb	1.00	S/ 3,100.32	S/ 3,100.32	0.00	S/ -	0.00%	0.00	0.00	0.00%	0.00	S/0.00	0.00%	1.00	3,100.32	100.00%
	COSTO DIRECTO				44,080.71		31,096.69	1.22%		0.00	0.00%		31,096.69	70.54%		12,984.02	29.46%
	GASTOS GENERALES		20.083931%		8,853.14		6,245.44			0.00		6,245.44			2,607.70		
	UTILIDAD		2.32247929%		1,023.77		722.21			0.00		722.21			301.55		
	SUB TOTAL				53,957.61		38,064.34			0.00		38,064.34			15,893.28		
	IGV 18%		18.00%		9,712.37		6,851.58			0.00		6,851.58			2,860.79		
	PRESUPUESTO TOTAL				63,669.99		44,915.92			0.00		44,915.92			18,754.07		

CONSORCIO MARITIMO DEL NORTE
DESEMBARCADERO ARTESANAL DE SUPE

DANIEL JOAQUIN MORALES VIVAS
RESIDENTE DE OBRA
REG. CIP N° 98098

000000



**VALORIZACIÓN N° 18 DEL 01 AL 28 DE FEBRERO DE 2019
(PRECIOS UNITARIOS)**

Contrato N° 025-2017- FONDEPES Ejecución de la Obra: MEJORAMIENTO DE LOS SERVICIOS DEL DESEMBARCADERO PESQUERO ARTESANAL DE SUPE, REGION LIMA, PROVINCIA DE BARRANCA, DISTRITO DE SUPE PUERTO



OBRA: MEJORAMIENTO DE LOS SERVICIOS DEL DESEMBARCADERO PESQUERO ARTESANAL DE SUPE ,REGION LIMA, PROVINCIA DE BARRANCA, DISTRITO DE SUPE PUERTO
 PROP. FONDEPES
 COHT. CONSORCIO MARITIMO DEL NORTE
 SUP. CESEL
FORMULA POLINÓMICA N° 01: OBRAS PORTUARIAS

Valorización N°:	18
Fecha:	mié 27 Feb 2019
Monto Contrato:	S/. 8,897,118.06 (S/. IGV.) S/. 10,498,599.31 (C/. IGV.)

Fórmula	Presupuesto		Avance Acumulado Anterior		Avance Actual		Avance Acumulado Actual		Saldo por Ejecutar		
	Descripción	Monto Total	Valorizado	%	Valorizado	%	Valorizado	%	Valorizado	%	
	Obra a Precios unitarios										
01	VALORIZACIÓN N° 18 DEL 01 AL 28 DE FEBRERO DE 2019 (PRECIOS UNITARIOS)	8,897,118.06	3,307,536.97	37.18%	442,979.08	4.98%	3,750,516.04	42.15%	5,146,602.01	57.85%	
Sub Total Presupuesto (S/. IGV)		8,897,118.06	3,307,536.97	37.18%	442,979.08	4.98%	3,750,516.04	42.15%	5,146,602.01	57.85%	

FORMULA POLINÓMICA N° 02:

EDIFICIO EN TIERRA ESTRUCTURA

Valorización N°:	18
Fecha:	mié 27 Feb 2019
Monto Contrato:	S/. 3,691,408.51 (S/. IGV.) S/. 4,355,862.04 (C/. IGV.)

Fórmula	Presupuesto		Avance Acumulado Anterior		Avance Actual		Avance Acumulado Actual		Saldo por Ejecutar	
	Descripción	Monto Total	Valorizado	%	Valorizado	%	Valorizado	%	Valorizado	%
01	VALORIZACIÓN N° 18 DEL 01 AL 28 DE FEBRERO DE 2019 (PRECIOS UNITARIOS)	3,532,361.09	2,834,424.52	80.24%	33,906.12	0.96%	2,868,330.63	81.20%	664,030.45	18.80%
Sub Total Presupuesto (S/. IGV)		3,532,361.09	2,834,424.52	80.24%	33,906.12	0.96%	2,868,330.63	81.20%	664,030.45	18.80%

FORMULA POLINÓMICA N° 03:

EDIFICIO EN TIERRA ARQUITECTURA

Valorización N°:	18
Fecha:	mié 27 Feb 2019
Monto Contrato:	S/. 1,738,221.23 (S/. IGV.) S/. 2,051,101.06 (C/. IGV.)

Fórmula	Presupuesto		Avance Acumulado Anterior		Avance Actual		Avance Acumulado Actual		Saldo por Ejecutar		
	Descripción	Monto Total	Valorizado	%	Valorizado	%	Valorizado	%	Valorizado	%	
	Obra a Precios unitarios										
01	VALORIZACIÓN N° 18 DEL 01 AL 28 DE FEBRERO DE 2019 (PRECIOS UNITARIOS)	1,738,221.23	574,331.16	33.04%	68,016.74	3.91%	642,347.90	36.95%	1,095,873.33	63.05%	
Sub Total Presupuesto (S/. IGV)		1,738,221.23	574,331.16	33.04%	68,016.74	3.91%	642,347.90	36.95%	1,095,873.33	63.05%	

CONSORCIO MARITIMO DEL NORTE
 DESEMBARCADERO ARTESANAL DE SUPE

DANIEL JOAQUIN MORALES VIVANCO
 RESIDENTE DE OBRA
 REG. CIP N° 98098

000027



VALORIZACIÓN N° 18 DEL 01 AL 28 DE FEBRERO DE 2019
(PRECIOS UNITARIOS)

Contrato N° 025-2017- FONDEPES Ejecución de la Obra: MEJORAMIENTO DE LOS SERVICIOS
DEL DESEMBARCADERO PESQUERO ARTESANAL DE SUPE, REGION LIMA, PROVINCIA DE
BARRANCA, DISTRITO DE SUPE PUERTO



OBRA: MEJORAMIENTO DE LOS SERVICIOS DEL DESEMBARCADERO PESQUERO ARTESANAL DE SUPE, REGION LIMA, PROVINCIA DE BARRANCA, DISTRITO DE SUPE PUERTO
PROP: FONDEPES
COINT: CONSORCIO MARITIMO DEL NORTE
SUP: CESEL

FORMULA POLINÓMICA N° 04:

EDIFICIO EN TIERRA INSTALACIONES ELECTRICAS

Valorización N°:	18
Fecha:	mié 27 Feb 2019
Monto Contrato:	S/. 653,003.57 (S/. IGV.) S/. 770,544.21 (C/. IGV.)

Fórmula	Presupuesto		Avance Acumulado Anterior		Avance Actual		Avance Acumulado Actual		Saldo por Ejecutar		
	Descripción	Monto Total	Valorizado	%	Valorizado	%	Valorizado	%	Valorizado	%	
	Obra a Precios unitarios										
01	VALORIZACIÓN N° 18 DEL 01 AL 28 DE FEBRERO DE 2019 (PRECIOS UNITARIOS)	158,866.47	35,414.48	22.29%	0.00	0.00%	35,414.48	22.29%	123,451.99	77.71%	
	Sub Total Presupuesto (S/. IGV)	158,866.47	35,414.48	22.29%	0.00	0.00%	35,414.48	22.29%	123,451.99	77.71%	

FORMULA POLINÓMICA N° 05:

EDIFICIO EN TIERRA INSTALACIONES SANITARIAS

Valorización N°:	18
Fecha:	mié 27 Feb 2019
Monto Contrato:	S/. 820,930.60 (S/. IGV.) S/. 968,698.10 (C/. IGV.)

Fórmula	Presupuesto		Avance Acumulado Anterior		Avance Actual		Avance Acumulado Actual		Saldo por Ejecutar		
	Descripción	Monto Total	Valorizado	%	Valorizado	%	Valorizado	%	Valorizado	%	
	Obra a Precios unitarios										
01	VALORIZACIÓN N° 18 DEL 01 AL 28 DE FEBRERO DE 2019 (PRECIOS UNITARIOS)	634,311.98	115,857.52	18.27%	941.86	0.15%	116,799.38	18.41%	517,512.60	81.59%	
	Sub Total Presupuesto (S/. IGV)	634,311.98	115,857.52	18.27%	941.86	0.15%	116,799.38	18.41%	517,512.60	81.59%	

FORMULA POLINÓMICA N° 06:

EDIFICIO EN TIERRA EQUIPAMIENTO

Valorización N°:	18
Fecha:	mié 27 Feb 2019
Monto Contrato:	S/. 2,373,404.06 (S/. IGV.) S/. 2,800,616.79 (C/. IGV.)

Fórmula	Presupuesto		Avance Acumulado Anterior		Avance Actual		Avance Acumulado Actual		Saldo por Ejecutar		
	Descripción	Monto Total	Valorizado	%	Valorizado	%	Valorizado	%	Valorizado	%	
	Obra a Precios unitarios										
01	VALORIZACIÓN N° 18 DEL 01 AL 28 DE FEBRERO DE 2019 (PRECIOS UNITARIOS)	2,373,404.06	1,378,948.60	58.10%	0.00	0.00%	1,378,948.60	58.10%	994,455.45	41.90%	
	Sub Total Presupuesto (S/. IGV)	2,373,404.06	1,378,948.60	58.10%	0.00	0.00%	1,378,948.60	58.10%	994,455.45	41.90%	

CONSORCIO MARITIMO DEL NORTE
DESEMBARCADERO ARTESANAL DE SUPE

DANIEL JOAQUIN MORALES VIZA NCO
RESIDENTE DE OBRA
REG. CIP N° 98098

003846



**VALORIZACIÓN N° 18 DEL 01 AL 28 DE FEBRERO DE 2019
(PRECIOS UNITARIOS)**

Contrato N° 025-2017- FONDEPES Ejecución de la Obra: MEJORAMIENTO DE LOS SERVICIOS DEL DESEMBARCADERO PESQUERO ARTESANAL DE SUPE, REGION LIMA, PROVINCIA DE BARRANCA, DISTRITO DE SUPE PUERTO



OBRA: MEJORAMIENTO DE LOS SERVICIOS DEL DESEMBARCADERO PESQUERO ARTESANAL DE SUPE ,REGION LIMA, PROVINCIA DE BARRANCA, DISTRITO DE SUPE PUERTO
 PROP. FONDEPES
 CONT. CONSORCIO MARITIMO DEL NORTE
 SUP. CESEL

FORMULA POLINÓMICA N° 07:

IMPACTO AMBIENTAL

Valorización N°:	18
Fecha:	mié 27 Feb 2019
Monto Contrato:	S/. 53,957.61 (S/. IGV.)
	S/. 63,669.99 (C/. IGV.)

Fórmula	Presupuesto		Avance Acumulado Anterior		Avance Actual		Avance Acumulado Actual		Saldo por Ejecutar	
	Descripción	Monto Total	Valorizado	%	Valorizado	%	Valorizado	%	Valorizado	%
	Obra a Precios unitarios									
01	VALORIZACION N° 18 DEL 01 AL 28 DE FEBRERO DE 2019 (PRECIOS UNITARIOS)	53,957.61	38,064.34	70.54%	0.00	0.00%	38,064.34	70.54%	15,893.28	29.46%
	Sub Total Presupuesto (S/. IGV)	53,957.61	38,064.34	70.54%	0.00	0.00%	38,064.34	70.54%	15,893.28	29.46%

RESUMEN GENERAL DE PRESUPUESTOS

Valorización N°:	18
Fecha:	mié 27 Feb 2019
Monto Contrato:	S/. 18,228,043.63 (S/. IGV.)
	S/. 21,509,091.49 (C/. IGV.)

PRESUPUESTO	Presupuesto		Avance Acumulado Anterior		Avance Actual		Avance Acumulado Actual		Saldo por Ejecutar	
	Descripción	Monto Total	Valorizado	%	Valorizado	%	Valorizado	%	Valorizado	%
	VALORIZACIÓN N° 18 DEL 01 AL 28 DE FEBRERO DE 2019 (PRECIOS UNITARIOS)	16,083,952.44	8,284,577.59	51.51%	545,843.79	3.39%	8,830,421.38	54.90%	8,557,819.12	53.21%
	Sub Total Presupuesto (S/. IGV)	16,083,952.44	8,284,577.59	51.51%	545,843.79	3.39%	8,830,421.38	54.90%	8,557,819.12	53.21%

CONSORCIO MARITIMO DEL NORTE
 DESEMBARCADERO ARTESANAL DE SUPE

 DANIEL JOAQUÍN MORALES VIVANCO
 RESIDENTE DE OBRA
 REG. CIP N° 98098

000345



VALORIZACIÓN N° 18 DEL 01 AL 28 DE FEBRERO DE 2019 (PRECIOS UNITARIOS)



Contrato N° 025-2017- FONDEPES Ejecución de la Obra: MEJORAMIENTO DE LOS SERVICIOS DEL DESEMBARCADERO PESQUERO ARTESANAL DE SUPE, REGION LIMA, PROVINCIA DE BARRANCA, DISTRITO DE SUPE PUERTO



VALORIZACIÓN N° 18 DEL 01 AL 28 DE FEBRERO DE 2019 (PRECIOS UNITARIOS)

OBRA: MEJORAMIENTO DE LOS SERVICIOS DEL DESEMBARCADERO PESQUERO ARTESANAL DE SUPE ,REGION LIMA, PROVINCIA DE BARRANCA, DISTRITO DE SUPE PUERTO
 PROP. FONDEPES
 CONT. CONSORCIO MARITIMO DEL NORTE
 SUP. CESEL

CUADRO DE REINTEGROS

FORMULA POLINOMICA N° 03:

EDIFICIO EN TIERRA ARQUITECTURA

MES	VAL N°	PROGRAMADO						EJECUTADO						
		Valorización Programada	Valorización Programada Acumulada	"K" del Mes		Reajuste V(K-1)	Reajuste Programado Acumulado	Valorización Ejecutada	Valorización Ejecutada Acumulada	"K" del Mes		Reajuste V(K-1)	Reajuste Ejecutado Acumulado	Reajuste Reconocido
				Mes	K					Mes	K			
Set-2017	01	S/. 0.00	S/. 0.00	Set-2017	1.019	0.000	S/. 0.00	S/. 0.00	S/. 0.00	Set-2017	1.019	0.00	S/. 0.00	0.00
Oct-2017	02	S/. 0.00	S/. 0.00	Set-2017	1.023	0.000	S/. 0.00	S/. 0.00	S/. 0.00	Set-2017	1.023	0.00	S/. 0.00	0.00
Nov-2017	03	S/. 0.00	S/. 0.00	Oct-2017	1.024	0.000	S/. 0.00	S/. 0.00	S/. 0.00	Oct-2017	1.024	0.00	S/. 0.00	0.00
Dic-2017	04	S/. 0.00	S/. 0.00	Nov-2017	1.022	0.000	S/. 0.00	S/. 0.00	S/. 0.00	Nov-2017	1.022	0.00	S/. 0.00	0.00
Ene-2018	05	S/. 30,792.04	S/. 30,792.04	Dic-2017	1.024	753.640	S/. 753.64	S/. 0.00	S/. 0.00	Dic-2017	1.024	0.00	S/. 0.00	0.00
Feb-2018	06	S/. 153,960.19	S/. 184,752.23	Ene-2018	1.049	7,517.312	S/. 8,270.95	S/. 31,040.65	S/. 31,040.65	Ene-2018	1.049	1,515.60	S/. 1,515.60	1,515.60
Mar-2018	07	S/. 0.00	S/. 184,752.23	Feb-2018	1.071	0.000	S/. 8,270.95	S/. 14,566.07	S/. 45,606.72	Feb-2018	1.071	1,026.96	S/. 2,542.56	1,026.96
Abr-2018	08	S/. 1,045,572.66	S/. 1,230,324.89	Mar-2018	1.072	75,336.156	S/. 83,607.11	S/. 36,673.40	S/. 82,280.12	Mar-2018	1.072	2,642.41	S/. 5,184.99	2,642.41
May-2018	09	S/. 507,896.34	S/. 1,738,221.23	Abr-2018	1.046	23,274.538	S/. 106,881.65	S/. 18,730.19	S/. 101,010.31	Abr-2018	1.046	858.32	S/. 6,043.29	858.32
Jun-2018	10	S/. 0.00	S/. 1,738,221.23	May-2018	1.051	0.000	S/. 106,881.65	S/. 51,186.57	S/. 152,196.88	May-2018	1.051	2,597.49	S/. 8,640.78	2,597.49
Jul-2018	11	S/. 0.00	S/. 1,738,221.23	Jun-2018	1.051	0.000	S/. 106,881.65	S/. 49,037.86	S/. 201,234.74	Jun-2018	1.051	2,498.69	S/. 11,139.47	2,498.69
Ago-2018	12	S/. 0.00	S/. 1,738,221.23	Jul-2018	1.052	0.000	S/. 106,881.65	S/. 87,261.74	S/. 288,496.49	Jul-2018	1.052	4,524.28	S/. 15,663.75	4,524.28
Set-2018	13	S/. 0.00	S/. 1,738,221.23	Ago-2018	1.072	0.000	S/. 106,881.65	S/. 34,748.19	S/. 323,244.68	Ago-2018	1.072	2,484.85	S/. 18,148.60	2,484.85
Oct-2018	14	S/. 0.00	S/. 1,738,221.23	Set-2018	1.074	0.000	S/. 106,881.65	S/. 70,095.06	S/. 393,339.74	Set-2018	1.074	5,164.70	S/. 23,313.30	5,164.70
Nov-2018	15	S/. 0.00	S/. 1,738,221.23	Oct-2018	1.076	0.000	S/. 106,881.65	S/. 76,668.78	S/. 470,008.52	Oct-2018	1.076	5,840.244	S/. 29,153.54	5,840.24
Dic-2018	16	S/. 0.00	S/. 1,738,221.23	Nov-2018	1.079	0.000	S/. 106,881.65	S/. 6,914.26	S/. 476,922.78	Nov-2018	1.079	546.793	S/. 29,700.34	546.79
Ene-2019	17	S/. 0.00	S/. 1,738,221.23	Dic-2018	1.079	0.000	S/. 106,881.65	S/. 97,408.39	S/. 574,331.16	Dic-2018	1.079	7,717.028	S/. 37,417.36	7,717.03
Feb-2019	18	S/. 0.00	S/. 1,738,221.23	Ene-2019	1.075	0.000	S/. 166,891.65	S/. 68,016.74	S/. 642,347.90	Ene-2019	1.075	5,106.357	S/. 42,523.72	5,106.36
TOTAL		S/. 1,738,221.23	S/. 1,738,221.23			S/. 106,891.65	S/. 642,347.90				S/. 42,523.72			

Acumulado Total	42,523.72
Acumulado Anterior	37,417.36
Reintegro del mes	5,106.36

CUADRO DE REINTEGROS

FORMULA POLINOMICA N° 04:

EDIFICIO EN TIERRA INSTALACIONES ELECTRICAS

MES	VAL N°	PROGRAMADO						EJECUTADO						
		Valorización Programada	Valorización Programada Acumulada	"K" del Mes		Reajuste V(K-1)	Reajuste Programado Acumulado	Valorización Ejecutada	Valorización Ejecutada Acumulada	"K" del Mes		Reajuste V(K-1)	Reajuste Ejecutado Acumulado	Reajuste Reconocido
				Mes	K					Mes	K			
Set-2017	01	S/. 0.00	S/. 0.00	Set-2017	0.918	0.000	S/. 0.00	S/. 0.00	S/. 0.00	Set-2017	0.918	0.000	S/. 0.00	S/. 0.00
Oct-2017	02	S/. 0.00	S/. 0.00	Set-2017	0.930	0.000	S/. 0.00	S/. 0.00	S/. 0.00	Set-2017	0.930	0.000	S/. 0.00	S/. 0.00
Nov-2017	03	S/. 0.00	S/. 0.00	Oct-2017	0.934	0.000	S/. 0.00	S/. 0.00	S/. 0.00	Oct-2017	0.934	0.000	S/. 0.00	S/. 0.00
Dic-2017	04	S/. 0.00	S/. 0.00	Nov-2017	0.935	0.000	S/. 0.00	S/. 0.00	S/. 0.00	Nov-2017	0.935	0.000	S/. 0.00	S/. 0.00
Ene-2018	05	S/. 19,095.40	S/. 19,095.40	Dic-2017	0.939	-1,173.158	S/. -1,173.16	S/. 0.00	S/. 0.00	Dic-2017	0.939	0.000	S/. 0.00	S/. 0.00
Feb-2018	06	S/. 59,132.39	S/. 78,227.79	Ene-2018	0.939	-3,636.046	S/. -4,809.20	S/. 0.00	S/. 0.00	Ene-2018	0.939	0.000	S/. 0.00	S/. 0.00
Mar-2018	07	S/. 330,995.30	S/. 409,223.09	Feb-2018	0.943	-18,794.928	S/. -23,604.13	S/. 7,886.62	S/. 7,886.62	Feb-2018	0.943	-447.826	S/. -447.83	S/. -447.83
Abr-2018	08	S/. 34,539.73	S/. 443,762.82	Mar-2018	0.944	-1,917.964	S/. -25,522.10	S/. 11,492.27	S/. 19,378.89	Mar-2018	0.944	-638.157	S/. -1,085.98	S/. -638.16
May-2018	09	S/. 3,418.44	S/. 447,181.27	Abr-2018	0.944	-191.878	S/. -25,713.97	S/. 10,808.63	S/. 30,187.53	Abr-2018	0.944	-606.691	S/. -1,692.67	S/. -606.69
Jun-2018	10	S/. 0.00	S/. 447,181.27	May-2018	0.951	0.000	S/. -25,713.97	S/. 0.00	S/. 30,187.53	May-2018	0.951	0.000	S/. -1,692.67	S/. 0.00
Jul-2018	11	S/. 447,181.27	S/. 447,181.27	Jun-2018	0.954	0.000	S/. -25,713.97	S/. 5,540.78	S/. 35,728.30	Jun-2018	0.954	-253.301	S/. -1,692.67	S/. -253.30
Ago-2018	12	S/. 447,181.27	S/. 447,181.27	Jul-2018	0.954	0.000	S/. -25,713.97	S/. -330.60	S/. 35,397.70	Jul-2018	0.954	15.164	S/. -1,692.67	S/. 15.16
Set-2018	13	S/. 447,181.27	S/. 447,181.27	Ago-2018	0.961	0.000	S/. -25,713.97	S/. 327.98	S/. 35,725.68	Ago-2018	0.961	186.129	S/. -1,692.67	S/. 186.13
Oct-2018	14	S/. 447,181.27	S/. 447,181.27	Set-2018	0.962	0.000	S/. -25,713.97	S/. -3,075.49	S/. 32,650.19	Set-2018	0.962	116.077	S/. -1,692.67	S/. 116.08
Nov-2018	15	S/. 447,181.27	S/. 447,181.27	Oct-2018	0.967	0.000	S/. -25,713.97	S/. 0.00	S/. 32,650.19	Oct-2018	0.967	0.000	S/. -1,692.67	S/. 0.00
Dic-2018	16	S/. 447,181.27	S/. 447,181.27	Nov-2018	0.968	0.000	S/. -25,713.97	S/. 0.00	S/. 32,650.19	Nov-2018	0.968	0.000	S/. -1,692.67	S/. 0.00
Ene-2019	17	S/. 447,181.27	S/. 447,181.27	Dic-2018	0.971	0.000	S/. -25,713.97	S/. 2,764.29	S/. 35,414.48	Dic-2018	0.971	-79.432	S/. -1,692.67	S/. 0.00
Feb-2019	18	S/. 0.00	S/. 447,181.27	Ene-2019	0.970	0.000	S/. -25,713.97	S/. 0.00	S/. 35,414.48	Ene-2019	0.970	0.000	S/. -1,692.67	S/. 0.00
TOTAL		S/. 447,181.27	S/. 447,181.27			S/. -25,713.97	S/. -25,713.97	S/. 35,414.48			S/. -1,708.04			

Acumulado Total	-1,708.04
Acumulado Anterior	-1,708.04
Reintegro del mes	0.00

CONSORCIO MARITIMO DEL NORTE
 DESEMBARCADERO ARTESANAL DE SUPE

DANIEL JOAQUIN MORALES VIVIACO
 RESIDENTE DE OBRA
 REG. CIP N° 98098

000343



VALORIZACIÓN N° 18 DEL 01 AL 28 DE FEBRERO DE 2019 (PRECIOS UNITARIOS)



Contrato N° 025-2017- FONDEPES Ejecución de la Obra: MEJORAMIENTO DE LOS SERVICIOS DEL DESEMBARCADERO PESQUERO ARTESANAL DE SUPE, REGION LIMA, PROVINCIA DE BARRANCA, DISTRITO DE SUPE PUERTO



VALORIZACIÓN N° 18 DEL 01 AL 28 DE FEBRERO DE 2019 (PRECIOS UNITARIOS)

OBRA: MEJORAMIENTO DE LOS SERVICIOS DEL DESEMBARCADERO PESQUERO ARTESANAL DE SUPE, REGION LIMA, PROVINCIA DE BARRANCA, DISTRITO DE SUPE PUERTO
 PROP. FONDEPES
 CONT. CONSORCIO MARITIMO DEL NORTE
 SUP. CESEL

CUADRO DE REINTEGROS

FORMULA POLINOMICA N° 05: EDIFICIO EN TIERRA INSTALACIONES SANITARIAS

MES	VAL N°	PROGRAMADO						EJECUTADO						
		Valorización Programada	Valorización Programada Acumulada	"K" del Mes		Reajuste V(K-1)	Reajuste Programado Acumulado	Valorización Ejecutada	Valorización Ejecutada Acumulada	"K" del Mes		Reajuste V(K-1)	Reajuste Ejecutado Acumulado	Reajuste Reconocido
				Mes	K					Mes	K			
Set-2107	01	S/. 0.00	S/. 0.00	Set-2017	1.139	0.000	S/. 0.00	S/. 0.00	S/. 0.00	Set-2017	1.139	0.000	S/. 0.00	0.000
Oct-2017	02	S/. 0.00	S/. 0.00	Set-2107	1.140	0.000	S/. 0.00	S/. 0.00	S/. 0.00	Set-2107	1.140	0.000	S/. 0.00	0.000
Nov-2017	03	S/. 138,638.45	S/. 138,638.45	Oct-2017	1.141	19,910.148	S/. 19,910.15	S/. 0.00	S/. 0.00	Oct-2017	1.141	0.000	S/. 0.00	0.000
Dic-2017	04	S/. 328,824.40	S/. 467,462.85	Nov-2017	1.143	46,953.932	S/. 66,864.08	S/. 0.00	S/. 0.00	Nov-2017	1.143	0.000	S/. 0.00	0.000
Ene-2018	05	S/. 135,896.00	S/. 603,358.85	Dic-2017	1.143	19,458.979	S/. 86,323.06	S/. 0.00	S/. 0.00	Dic-2017	1.143	0.000	S/. 0.00	0.000
Feb-2018	06	S/. 0.00	S/. 603,358.85	Ene-2018	1.143	0.000	S/. 86,323.06	S/. 0.00	S/. 0.00	Ene-2018	1.143	0.000	S/. 0.00	0.000
Mar-2018	07	S/. 0.00	S/. 603,358.85	Feb-2018	1.150	0.000	S/. 86,323.06	S/. 4,508.32	S/. 4,508.32	Feb-2018	1.150	677.495	S/. 677.50	677.495
Abr-2018	08	S/. 0.00	S/. 603,358.85	Mar-2018	1.154	0.000	S/. 86,323.06	S/. 0.00	S/. 4,508.32	Mar-2018	1.154	0.000	S/. 677.50	0.000
May-2018	09	S/. 30,953.13	S/. 634,311.98	Abr-2018	1.154	4,777.294	S/. 91,100.35	S/. 8,359.00	S/. 12,967.32	Abr-2018	1.154	1,290.125	S/. 1,967.62	1,290.125
Jun-2018	10	S/. 0.00	S/. 634,311.98	May-2018	1.160	0.000	S/. 91,100.35	S/. 0.00	S/. 12,967.32	May-2018	1.160	0.000	S/. 1,967.62	0.000
Jul-2018	11	S/. 0.00	S/. 634,311.98	Jun-2018	1.162	0.000	S/. 91,100.35	S/. 3,876.38	S/. 16,743.70	Jun-2018	1.162	626.924	S/. 2,594.54	626.924
Ago-2018	12	S/. 265,685.25	S/. 899,997.23	Jul-2018	1.162	0.000	S/. 91,100.35	S/. 908.49	S/. 17,652.19	Jul-2018	1.162	147.597	S/. 2,742.14	147.597
Set-2018	13	S/. 265,685.25	S/. 1,165,682.48	Ago-2018	1.179	0.000	S/. 91,100.35	S/. 0.00	S/. 17,652.19	Ago-2018	1.179	-734.155	S/. 2,007.99	-734.155
Oct-2018	14	S/. 265,686.25	S/. 1,431,368.73	Set-2018	1.182	0.000	S/. 91,100.35	S/. 4,289.91	S/. 21,942.10	Set-2018	1.182	781.891	S/. 2,789.89	781.891
Nov-2018	15	S/. 265,687.25	S/. 1,697,055.98	Oct-2018	1.183	0.000	S/. 91,100.35	S/. 0.00	S/. 21,942.10	Oct-2018	1.183	0.000	S/. 2,789.89	0.000
Dic-2018	16	S/. 265,687.25	S/. 1,962,743.23	Nov-2018	1.185	0.000	S/. 91,100.35	S/. 84,390.65	S/. 106,332.75	Nov-2018	1.185	15,619.457	S/. 18,409.33	15,619.457
Ene-2019	17	S/. 265,687.25	S/. 2,228,430.48	Dic-2018	1.182	0.000	S/. 91,100.35	S/. 9,524.77	S/. 115,857.52	Dic-2018	1.182	1,731.116	S/. 20,140.45	1,731.116
Feb-2019	18	S/. 265,687.25	S/. 2,494,117.73	Ene-2019	1.178	0.000	S/. 91,100.35	S/. 941.86	S/. 116,799.38	Ene-2019	1.178	167.737	S/. 20,308.19	167.737
TOTAL		S/. 634,311.98				S/. 91,100.35		S/. 116,799.38			S/. 20,308.19		S/. 20,308.19	

Acumulado Total	20,308.19
Acumulado Anterior	20,140.45
Reintegro del mes	167.74

CUADRO DE REINTEGROS

FORMULA POLINOMICA N° 06: EDIFICIO EN TIERRA EQUIPAMIENTO

MES	VAL N°	PROGRAMADO						EJECUTADO						
		Valorización Programada	Valorización Programada Acumulada	"K" del Mes		Reajuste V(K-1)	Reajuste Programado Acumulado	Valorización Ejecutada	Valorización Ejecutada Acumulada	"K" del Mes		Reajuste V(K-1)	Reajuste Ejecutado Acumulado	Reajuste Reconocido
				Mes	K					Mes	K			
Set-2107	01	S/. 0.00	S/. 0.00	Set-2017	0.995	0.000	S/. 0.00	S/. 0.00	S/. 0.00	Set-2017	0.995	0.000	S/. 0.00	S/. 0.00
Oct-2017	02	S/. 0.00	S/. 0.00	Set-2107	0.997	0.000	S/. 0.00	S/. 0.00	S/. 0.00	Set-2107	0.997	0.000	S/. 0.00	S/. 0.00
Nov-2017	03	S/. 0.00	S/. 0.00	Oct-2017	0.999	0.000	S/. 0.00	S/. 0.00	S/. 0.00	Oct-2017	0.999	0.000	S/. 0.00	S/. 0.00
Dic-2017	04	S/. 0.00	S/. 0.00	Nov-2017	0.995	0.000	S/. 0.00	S/. 0.00	S/. 0.00	Nov-2017	0.995	0.000	S/. 0.00	S/. 0.00
Ene-2018	05	S/. 0.00	S/. 0.00	Dic-2017	0.999	0.000	S/. 0.00	S/. 0.00	S/. 0.00	Dic-2017	0.999	0.000	S/. 0.00	S/. 0.00
Feb-2018	06	S/. 0.00	S/. 0.00	Ene-2018	0.990	0.000	S/. 0.00	S/. 0.00	S/. 0.00	Ene-2018	0.990	0.000	S/. 0.00	S/. 0.00
Mar-2018	07	S/. 0.00	S/. 0.00	Feb-2018	1.003	0.000	S/. 0.00	S/. 0.00	S/. 0.00	Feb-2018	1.003	0.000	S/. 0.00	S/. 0.00
Abr-2018	08	S/. 51,539.06	S/. 51,539.06	Mar-2018	1.006	284.795	S/. 284.80	S/. 0.00	S/. 0.00	Mar-2018	1.006	0.000	S/. 0.00	S/. 0.00
May-2018	09	S/. 1,839,480.97	S/. 1,891,020.03	Abr-2018	1.002	3,419.295	S/. 3,704.09	S/. 0.00	S/. 0.00	Abr-2018	1.002	0.000	S/. 0.00	S/. 0.00
Jun-2018	10	S/. 482,384.03	S/. 2,373,404.06	May-2018	1.018	8,469.562	S/. 12,173.65	S/. 0.00	S/. 0.00	May-2018	1.018	0.000	S/. 0.00	S/. 0.00
Jul-2018	11	S/. 0.00	S/. 2,373,404.06	Jun-2018	1.018	0.000	S/. 12,173.65	S/. 0.00	S/. 0.00	Jun-2018	1.018	0.000	S/. 0.00	S/. 0.00
Ago-2018	12	S/. 2,373,404.06	S/. 4,746,808.12	Jul-2018	1.021	0.000	S/. 12,173.65	S/. 1,378,948.60	S/. 1,378,948.60	Jul-2018	1.021	29,404.775	S/. 29,404.78	S/. 29,404.78
Set-2018	13	S/. 2,373,404.06	S/. 7,120,212.18	Ago-2018	1.029	0.000	S/. 12,173.65	S/. 0.00	S/. 1,378,948.60	Ago-2018	1.029	0.000	S/. 29,404.78	S/. 0.000
Oct-2018	14	S/. 2,373,404.06	S/. 9,493,616.24	Set-2018	1.038	0.000	S/. 12,173.65	S/. 0.00	S/. 1,378,948.60	Set-2018	1.038	0.000	S/. 29,404.78	S/. 0.000
Nov-2018	15	S/. 2,373,404.06	S/. 11,867,020.30	Oct-2018	1.046	0.000	S/. 12,173.65	S/. 0.00	S/. 1,378,948.60	Oct-2018	1.046	0.000	S/. 29,404.78	S/. 0.000
Dic-2018	16	S/. 2,373,404.06	S/. 14,240,424.36	Nov-2018	1.060	0.000	S/. 12,173.65	S/. 0.00	S/. 1,378,948.60	Nov-2018	1.060	0.000	S/. 29,404.78	S/. 0.000
Ene-2019	17	S/. 2,373,404.06	S/. 16,613,828.42	Dic-2018	1.059	0.000	S/. 12,173.65	S/. 0.00	S/. 1,378,948.60	Dic-2018	1.059	0.000	S/. 29,404.78	S/. 0.000
Feb-2019	18	S/. 2,373,404.06	S/. 18,987,232.48	Ene-2019	1.055	0.000	S/. 12,173.65	S/. 0.00	S/. 1,378,948.60	Ene-2019	1.055	0.000	S/. 29,404.78	S/. 0.000
TOTAL		S/. 2,373,404.06				S/. 12,173.65		S/. 1,378,948.60			S/. 29,404.78		S/. 29,404.78	

Acumulado Total	29,404.78
Acumulado Anterior	29,404.78
Reintegro del mes	0.00

CONSORCIO MARITIMO DEL NORTE
 DESEMBARCADERO ARTESANAL DE SUPE
 DANIEL JOAQUIN MORALES VIVA YCO
 RESIDENTE DE OBRA
 REG. CIP N° 98098

000342



VALORIZACIÓN N° 18 DEL 01 AL 28 DE FEBRERO DE 2019 (PRECIOS UNITARIOS)



Contrato N° 025-2017- FONDEPES Ejecución de la Obra: MEJORAMIENTO DE LOS SERVICIOS DEL DESEMBARCADERO PESQUERO ARTESANAL DE SUPE, REGION LIMA, PROVINCIA DE BARRANCA, DISTRITO DE SUPE PUERTO



VALORIZACIÓN N° 18 DEL 01 AL 28 DE FEBRERO DE 2019 (PRECIOS UNITARIOS)

OBRA: MEJORAMIENTO DE LOS SERVICIOS DEL DESEMBARCADERO PESQUERO ARTESANAL DE SUPE ,REGION LIMA, PROVINCIA DE BARRANCA, DISTRITO DE SUPE PUERTO
 PROP. FONDEPES
 CONT. CONSORCIO MARITIMO DEL NORTE
 SUP. CESEL

CUADRO DE REINTEGROS

FORMULA POLINOMICA N° 07:

IMPACTO AMBIENTAL

MES	VAL N°	PROGRAMADO						EJECUTADO						
		Valorización Programada	Valorización Programada Acumulada	"K" del Mes		Reajuste V(K-1)	Reajuste Programado Acumulado	Valorización Ejecutada	Valorización Ejecutada Acumulada	"K" del Mes		Reajuste V(K-1)	Reajuste Ejecutado Acumulado	Reajuste Reconocido
				Mes	K					Mes	K			
Set-2017	01	S/. 12,168.70	S/. 12,168.70	Set-2017	1.011	136.596	S/. 136.60	S/. 11,730.38	S/. 11,730.38	Set-2017	1.011	131.676	S/. 131.68	S/. 131.68
Oct-2017	02	S/. 10,043.51	S/. 22,212.21	Set-2017	1.012	115.650	S/. 252.25	S/. 6,602.88	S/. 18,333.26	Set-2017	1.012	76.031	S/. 207.71	S/. 76.03
Nov-2017	03	S/. 3,726.72	S/. 25,938.93	Oct-2017	1.006	23.482	S/. 275.73	S/. 1,696.97	S/. 20,030.23	Oct-2017	1.006	10.693	S/. 218.40	S/. 10.69
Dic-2017	04	S/. 3,850.95	S/. 29,789.88	Nov-2017	1.006	22.661	S/. 298.39	S/. 3,106.81	S/. 23,137.04	Nov-2017	1.006	18.282	S/. 236.68	S/. 18.28
Ene-2018	05	S/. 3,850.95	S/. 33,640.83	Dic-2017	1.006	24.265	S/. 322.65	S/. 1,825.80	S/. 24,962.84	Dic-2017	1.006	11.306	S/. 247.99	S/. 11.31
Feb-2018	06	S/. 3,478.27	S/. 37,119.10	Ene-2018	1.007	23.661	S/. 346.31	S/. 1,114.13	S/. 26,076.97	Ene-2018	1.007	7.579	S/. 255.57	S/. 7.58
Mar-2018	07	S/. 3,850.95	S/. 40,970.04	Feb-2018	1.006	24.453	S/. 370.77	S/. 1,393.80	S/. 27,475.77	Feb-2018	1.006	8.882	S/. 264.45	S/. 8.88
Abr-2018	08	S/. 3,726.72	S/. 44,696.77	Mar-2018	1.011	42.285	S/. 413.05	S/. 1,114.13	S/. 28,589.90	Mar-2018	1.011	12.641	S/. 277.09	S/. 12.64
May-2018	09	S/. 5,500.94	S/. 50,197.71	Abr-2018	1.010	57.039	S/. 470.09	S/. 4,353.49	S/. 32,943.39	Abr-2018	1.010	45.141	S/. 322.23	S/. 45.14
Jun-2018	10	S/. 3,759.91	S/. 53,957.61	May-2018	1.018	65.805	S/. 535.90	S/. 2,276.85	S/. 35,220.24	May-2018	1.018	39.849	S/. 362.08	S/. 39.85
Jul-2018	11		S/. 53,957.61	Jun-2018	1.017	0.000	S/. 535.90	S/. 675.35	S/. 35,895.59	Jun-2018	1.017	11.661	S/. 373.74	S/. 11.66
Ago-2018	12		S/. 53,957.61	Jul-2018	1.018	0.000	S/. 535.90	S/. 447.25	S/. 36,342.85	Jul-2018	1.018	7.933	S/. 381.67	S/. 7.93
Set-2018	13		S/. 53,957.61	Ago-2018	1.030	0.000	S/. 535.90	S/. 1,572.41	S/. 37,915.25	Ago-2018	1.030	46.574	S/. 428.25	S/. 46.57
Oct-2018	14		S/. 53,957.61	Set-2018	1.035	0.000	S/. 535.90	S/. 59.63	S/. 37,974.89	Set-2018	1.035	2.099	S/. 430.35	S/. 2.10
Nov-2018	15		S/. 53,957.61	Oct-2018	1.032	0.000	S/. 535.90	S/. 29.82	S/. 38,004.71	Oct-2018	1.032	0.967	S/. 431.31	S/. 0.97
Dic-2018	16		S/. 53,957.61	Nov-2018	1.032	0.000	S/. 535.90	S/. 29.82	S/. 38,034.52	Nov-2018	1.032	0.967	S/. 432.28	S/. 0.97
Ene-2019	17		S/. 53,957.61	Dic-2018	1.032	0.000	S/. 535.90	S/. 0.00	S/. 38,004.71	Dic-2018	1.032	0.000	S/. 432.28	S/. 0.00
Feb-2019	18		S/. 53,957.61	Ene-2019	1.030	0.000	S/. 535.90	S/. 0.00	S/. 38,034.52	Ene-2019	1.030	0.000	S/. 432.28	S/. 0.00
TOTAL		S/. 53,957.61					S/. 535.90	S/. 38,034.52				S/. 432.28		

Acumulado Total	432.28
Acumulado Anterior	432.28
Reintegro del mes	0.00

CONSORCIO MARITIMO DEL NORTE
 DESEMBARCADERO ARTESANAL DE SUPE
 DANIEL JOAQUIN MORALES VIVANCO
 RESIDENTE DE OBRA
 REG. CIP N° 98098

000341



VALORIZACIÓN N° 18 DEL 01 AL 28 DE FEBRERO DE 2019
(PRECIOS UNITARIOS)



Contrato N° 025-2017- FONDEPES Ejecución de la Obra: MEJORAMIENTO DE LOS SERVICIOS DEL DESEMBARCADERO PESQUERO ARTESANAL DE SUPE, REGION LIMA, PROVINCIA DE BARRANCA, DISTRITO DE SUPE PUERTO



OBRA: MEJORAMIENTO DE LOS SERVICIOS DEL DESEMBARCADERO PESQUERO ARTESANAL DE SUPE ,REGION LIMA, PROVINCIA DE BARRANCA, DISTRITO DE SUPE PUERTO
PROP. FONDEPES
CONT. CONSORCIO MARITIMO DEL NORTE
SUP. CESEL

CUADRO DE AMORTIZACIONES

FORMULA POLINOMICA N° 01:

OBRAS PORTUARIAS

Adelanto Directo- N° 01

Monto Contrato (S/I.G.V.)	Concepto	Monto Otorgado	Amortiz.Acum. Anterior		Amortización Actual		Amortiz Acum. Actual		Saldo por Amortizar	
			Amortizado	%	Amortizado	%	Amortizado	%	Monto	%
S/. 8,897,118.06	Adelanto Directo (10%)	S/. 889,711.81	S/. 341,718.22	38.41%	S/. 54,929.41	6.17%	S/. 396,647.63	44.58%	S/. 493,064.18	55.42%
Total Otorgado	Monto Contrato	S/. 889,711.81	S/. 341,718.22	38.41%	S/. 54,929.41	6.17%	S/. 396,647.63	44.58%	S/. 493,064.18	55.42%

FORMULA POLINÓMICA N° 02:

EDIFICIO EN TIERRA ESTRUCTURA

Adelanto Directo- N° 01

Monto Contrato (S/I.G.V.)	Concepto	Monto Otorgado	Amortiz.Acum. Anterior		Amortización Actual		Amortiz Acum. Actual		Saldo por Amortizar	
			Amortizado	%	Amortizado	%	Amortizado	%	Monto	%
S/. 3,691,408.51	Adelanto Directo (10%)	S/. 369,140.85	S/. 305,630.78	82.80%	S/. 4,204.36	1.14%	S/. 309,835.14	83.94%	S/. 59,305.71	16.07%
Total Otorgado	Monto Contrato	S/. 369,140.85	S/. 305,630.78	82.80%	S/. 4,204.36	1.14%	S/. 309,835.14	83.94%	S/. 59,305.71	16.06%

FORMULA POLINÓMICA N° 03:

EDIFICIO EN TIERRA ARQUITECTURA

Adelanto Directo- N° 01

Monto Contrato (S/I.G.V.)	Concepto	Monto Otorgado	Amortiz.Acum. Anterior		Amortización Actual		Amortiz Acum. Actual		Saldo por Amortizar	
			Amortizado	%	Amortizado	%	Amortizado	%	Monto	%
S/. 1,738,221.23	Adelanto Directo (10%)	S/. 173,822.12	S/. 66,810.79	38.44%	S/. 8,434.08	4.85%	S/. 75,244.86	43.29%	S/. 98,577.26	56.71%
Total Otorgado	Monto Contrato	S/. 173,822.12	S/. 66,810.79	38.44%	S/. 8,434.08	4.85%	S/. 75,244.86	43.29%	S/. 98,577.26	56.71%

CONSORCIO MARITIMO DEL NORTE
DESEMBARCADERO ARTESANAL DE SUPE
[Firma]
DANIEL JOAQUIN MORALES VIVANCO
RESIDENTE DE OBRA
REG. CIP N° 98098

000340



VALORIZACIÓN N° 18 DEL 01 AL 28 DE FEBRERO DE 2019
(PRECIOS UNITARIOS)



Contrato N° 025-2017- FONDEPES Ejecución de la Obra: MEJORAMIENTO DE LOS SERVICIOS DEL DESEMBARCADERO PESQUERO ARTESANAL DE SUPE, REGION LIMA, PROVINCIA DE BARRANCA, DISTRITO DE SUPE PUERTO



OBRA: MEJORAMIENTO DE LOS SERVICIOS DEL DESEMBARCADERO PESQUERO ARTESANAL DE SUPE, REGION LIMA, PROVINCIA DE BARRANCA, DISTRITO DE SUPE PUERTO
PROP. FONDEPES
CONT. CONSORCIO MARITIMO DEL NORTE
SUP. CESEL

CUADRO DE AMORTIZACIONES

FORMULA POLINÓMICA N° 04: EDIFICIO EN TIERRA INSTALACIONES ELECTRICAS
Adelanto Directo- N° 01

Monto Contrato (S/I.G.V.)	Concepto	Monto Otorgado	Amortiz.Acum. Anterior		Amortización Actual		Amortiz Acum. Actual		Saldo por Amortizar	
			Amortizado	%	Amortizado	%	Amortizado	%	Monto	%
S/. 653,003.57	Adelanto Directo (10%)	S/. 65,300.36	S/. 3,998.91	6.12%	S/. 0.00	0.00%	S/. 3,998.91	6.12%	S/. 61,301.45	93.88%
Total Otorgado	Monto Contrato	S/. 65,300.36	S/. 3,998.91	6.12%	S/. 0.00	0.00%	S/. 3,998.91	6.12%	S/. 61,301.45	93.88%

FORMULA POLINÓMICA N° 05: EDIFICIO EN TIERRA INSTALACIONES SANITARIAS
Adelanto Directo- N° 01

Monto Contrato (S/I.G.V.)	Concepto	Monto Otorgado	Amortiz.Acum. Anterior		Amortización Actual		Amortiz Acum. Actual		Saldo por Amortizar	
			Amortizado	%	Amortizado	%	Amortizado	%	Monto	%
S/. 820,930.60	Adelanto Directo (10%)	S/. 82,093.06	S/. 13,761.94	16.76%	S/. 116.79	0.14%	S/. 13,878.73	16.90%	S/. 68,214.33	83.09%
Total Otorgado	Monto Contrato	S/. 82,093.06	S/. 13,761.94	16.76%	S/. 116.79	0.14%	S/. 13,878.73	16.90%	S/. 68,214.33	83.10%

FORMULA POLINÓMICA N° 06: EDIFICIO EN TIERRA EQUIPAMIENTO
Adelanto Directo- N° 01

Monto Contrato (S/I.G.V.)	Concepto	Monto Otorgado	Amortiz.Acum. Anterior		Amortización Actual		Amortiz Acum. Actual		Saldo por Amortizar	
			Amortizado	%	Amortizado	%	Amortizado	%	Monto	%
S/. 2,373,404.06	Adelanto Directo (10%)	S/. 237,340.41	S/. 154,993.82	65.30%	S/. 0.00	0.00%	S/. 154,993.82	65.30%	S/. 82,346.59	34.70%
Total Otorgado	Monto Contrato	S/. 237,340.41	S/. 154,993.82	65.30%	S/. 0.00	0.00%	S/. 154,993.82	65.30%	S/. 82,346.59	34.70%

FORMULA POLINÓMICA N° 07: IMPACTO AMBIENTAL
Adelanto Directo- N° 01

Monto Contrato (S/I.G.V.)	Concepto	Monto Otorgado	Amortiz.Acum. Anterior		Amortización Actual		Amortiz Acum. Actual		Saldo por Amortizar	
			Amortizado	%	Amortizado	%	Amortizado	%	Monto	%
S/. 53,957.61	Adelanto Directo (10%)	S/. 5,395.76	S/. 4,000.49	74.14%	S/. 0.00	0.00%	S/. 4,000.49	74.14%	S/. 1,395.27	25.86%
Total Otorgado	Monto Contrato	S/. 5,395.76	S/. 4,000.49	74.14%	S/. 0.00	0.00%	S/. 4,000.49	74.14%	S/. 1,395.27	25.86%

CONSORCIO MARITIMO DEL NORTE
DESEMBARCADERO ARTESANAL DE SUPE
DANIEL JOAQUIN MORALES VIVA NCO
RESIDENTE DE OBRA
REG. CIP N° 98098

000339



VALORIZACIÓN N° 18 DEL 01 AL 28 DE FEBRERO DE 2019
(PRECIOS UNITARIOS)



Contrato N° 025-2017- FONDEPES Ejecución de la Obra: MEJORAMIENTO DE LOS SERVICIOS DEL DESEMBARCADERO PESQUERO ARTESANAL DE SUPE, REGION LIMA, PROVINCIA DE BARRANCA, DISTRITO DE SUPE PUERTO



OBRA: MEJORAMIENTO DE LOS SERVICIOS DEL DESEMBARCADERO PESQUERO ARTESANAL DE SUPE, REGION LIMA, PROVINCIA DE BARRANCA, DISTRITO DE SUPE PUERTO
PROP. FONDEPES
CONT. CONSORCIO MARITIMO DEL NORTE
SUP. CESEL

FORMULA POLINOMICA N° 01:

OBRAS PORTUARIAS

AMORTIZACIÓN Y DEDUCCIÓN DEL ADELANTO DIRECTO - N° 01

Monto Adelanto Directo (Sin I.G.V.): S/. 1,103,242.64
Fecha de Pago: Ago-2017

A/C= 12.40%

Monto Contratado (Sin I.G.V.): 8,997,118.06
Monto Adelanto Directo asignado (Sin I.G.V.): S/. 889,711.81

N°	Mes	Valorización Monto Total (1)	Amortización en el mes (2) = (1)*(A/C)	Deuda al Mes Anterior (3)	Saldo al Mes (3) - (2)	"K" del Mes		"K" al Pago (AGOSTO 2017)	Coeficiente	Deducción Adelanto Directo N° 01
						Mes	K			
01	Set-17	106,436.31	10,643.63	889,711.81	879,068.18	Ago-17	1.0215	1.0215	0.0000	0.00
02	Oct-17	844,357.40	84,435.74	879,068.18	794,632.44	Set-17	1.025	1.0215	0.0037	316.20
03	Nov-17	392,242.78	39,224.28	794,632.44	755,408.16	Oct-17	1.024	1.0215	0.0028	109.15
04	Dic-17	1,187,259.48	118,725.95	755,408.16	636,682.21	Nov-17	1.021	1.0215	-0.0003	
05	Ene-18	328,038.47	36,871.52	636,682.21	599,810.69	Dic-17	1.026	1.0215	0.0040	125.76
06	Feb-18	153,293.00	17,230.13	599,810.69	582,580.56	Ene-18	1.0268	1.0215	0.0052	89.56
07	Mar-18	-75,269.47	-8,460.29	582,580.56	591,040.85	Feb-18	1.0488	1.0215	0.0268	
08	Abr-18	29,558.99	3,322.43	591,040.85	587,718.42	Mar-18	1.0535	1.0215	0.0314	104.20
09	May-18	21,343.47	2,399.01	587,718.42	585,319.41	Abr-18	1.0504	1.0215	0.0283	67.89
10	Jun-18	87,013.77	9,780.35	585,319.41	575,539.06	May-18	1.0613	1.0215	0.0390	381.38
11	Jul-18	47,706.78	5,362.24	575,539.06	570,176.82	Jun-18	1.0588	1.0215	0.0366	196.12
12	Ago-18	20,567.19	2,311.75	570,176.82	567,865.07	Jul-18	1.0612	1.0215	0.0389	89.87
13	Set-18	0.00	0.00	567,865.07	567,865.07	Ago-18	1.0764	1.0215	0.0537	0.00
14	Oct-18	0.00	0.00	567,865.07	567,865.07	Set-18	1.0811	1.0215	0.0584	0.00
15	Nov-18	110,459.82	13,211.00	567,865.07	554,654.07	Oct-18	1.0827	1.0215	0.0599	791.79
16	Dic-18	22,978.88	2,748.27	554,654.07	551,905.80	Nov-18	1.0842	1.0215	0.0614	168.63
17	Ene-19	31,550.09	3,912.21	551,905.80	547,993.59	Dic-18	1.0895	1.0215	0.0666	260.38
18	Feb-19	442,979.08	54,929.41	547,993.59	493,064.18	Ene-19	1.0853	1.0215	0.0625	3,432.97
Total		3,750,516.04	396,647.63							5,870.77

(*) : IU conocido hasta el momento

Acumulado Total	5,870.77
Acumulado Anterior	2,437.80
Deducción del mes	3,432.97

Amortización Actual Febrero 2019)

54,929.41

Deducción Actual (Febrero 2019)

3,432.97

CONSORCIO MARITIMO DEL NORTE
DESEMBARCADERO ARTESANAL DE SUPE
DANIEL JOAQUIN MORALES VIVERO
RESIDENTE DE OBRA
REG. CIP N° 98098

000338



VALORIZACIÓN N° 18 DEL 01 AL 28 DE FEBRERO DE 2019
(PRECIOS UNITARIOS)



Contrato N° 025-2017- FONDEPES Ejecución de la Obra: MEJORAMIENTO DE LOS SERVICIOS DEL DESEMBARCADERO PESQUERO ARTESANAL DE SUPE, REGION LIMA, PROVINCIA DE BARRANCA, DISTRITO DE SUPE PUERTO



OBRA: MEJORAMIENTO DE LOS SERVICIOS DEL DESEMBARCADERO PESQUERO ARTESANAL DE SUPE ,REGION LIMA, PROVINCIA DE BARRANCA, DISTRITO DE SUPE PUERTO
PROP. FONDEPES
CONT. CONSORCIO MARITIMO DEL NORTE
SUP. CESEL

FORMULA POLINÓMICA N° 02:

EDIFICIO EN TIERRA ESTRUCTURA
AMORTIZACIÓN Y DEDUCCIÓN DEL ADELANTO DIRECTO - N° 01

Monto Adelanto Directo (Sin I.G.V.): S/. 457,734.65
Fecha de Pago: Ago-2017

A/C= 12.40%

Monto Contratado (Sin I.G.V.): S/. 3,691,408.51
Monto Adelanto Directo asignado (Sin I.G.V.): S/. 369,140.85

N°	Valorización		Amortización en el mes (2) = (1)*(A/C)	Deuda (3)	Saldo al Mes (3) - (2)	"K" del Mes		"K" al Pago (AGOSTO 2017)	Coeficiente	Deducción Adelanto Directo N° 01
	Mes	Monto Total (1)				Mes	K			
01	Set-17	119,395.59	11,939.56	369,140.85	357,201.29	Ago-17	1.015	1.015	0.0000	0.00
02	Oct-17	157,933.71	15,793.37	357,201.29	341,407.92	Set-17	1.017	1.015	0.0022	34.08
03	Nov-17	857,570.31	85,757.03	341,407.92	255,650.89	Oct-17	1.017	1.015	0.0025	218.54
04	Dic-17	138,517.05	13,851.71	255,650.89	241,799.18	Nov-17	1.015	1.015	0.0006	9.00
05	Ene-18	53,320.73	5,993.25	241,799.18	235,805.93	Dic-17	1.017	1.015	0.0027	16.21
06	Feb-18	253,267.64	28,467.28	235,805.93	207,338.65	Ene-18	1.020	1.015	0.0052	146.83
07	Mar-18	246,884.19	27,749.78	207,338.65	179,588.87	Feb-18	1.041	1.015	0.0260	720.49
08	Abr-18	51,812.01	5,823.67	179,588.87	173,765.20	Mar-18	1.044	1.015	0.0286	166.62
09	May-18	121,196.47	13,622.48	173,765.20	160,142.72	Abr-18	1.039	1.015	0.0243	330.62
10	Jun-18	134,191.86	16,014.72	160,142.72	145,059.55	May-18	1.046	1.015	0.0305	460.23
11	Jul-18	198,055.29	22,261.41	145,059.55	122,798.14	Jun-18	1.044	1.015	0.0292	649.47
12	Ago-18	104,581.60	11,754.97	122,798.14	111,043.17	Jul-18	1.046	1.015	0.0306	360.12
13	Set-18	10,478.58	1,230.18	111,043.17	109,812.99	Ago-18	1.059	1.015	0.0441	54.29
14	Oct-18	69,354.83	8,142.26	109,812.99	101,670.73	Set-18	1.061	1.015	0.0459	373.64
15	Nov-18	13,937.26	1,666.90	101,670.73	100,003.83	Oct-18	1.063	1.015	0.0481	70.25
16	Dic-18	271,189.75	32,434.29	100,003.83	67,569.54	Nov-18	1.065	1.015	0.0500	1,621.12
17	Ene-19	32,737.65	4,059.47	67,569.54	63,510.07	Dic-18	1.069	1.015	0.0532	215.79
18	Feb-19	33,906.12	4,204.36	63,510.07	59,305.71	Feb-19	1.066	1.015	0.0503	211.44
Total		2,868,330.63	309,835.14							5,658.74

(*) : IU conocido hasta el momento

Acumulado Total	5,658.74
Acumulado Anterior	5,447.30
Deducción del mes	211.44

Amortización Actual Febrero 2019)

4,204.36

Deducción Actual (Febrero 2019)

211.44

CONSORCIO MARITIMO DEL NORTE
DESEMBARCADERO ARTESANAL DE SUPE

DANIEL JOAQUÍN MORALES VIZA NCO
RESIDENTE DE OBRA
REG. CIP N° 98098

000337



VALORIZACIÓN N° 18 DEL 01 AL 28 DE FEBRERO DE 2019
(PRECIOS UNITARIOS)



Contrato N° 025-2017- FONDEPES Ejecucion de la Obra: MEJORAMIENTO DE LOS SERVICIOS DEL DESEMBARCADERO PESQUERO ARTESANAL DE SUPE, REGION LIMA, PROVINCIA DE BARRANCA, DISTRITO DE SUPE PUERTO



OBRA: MEJORAMIENTO DE LOS SERVICIOS DEL DESEMBARCADERO PESQUERO ARTESANAL DE SUPE ,REGION LIMA, PROVINCIA DE BARRANCA, DISTRITO DE SUPE PUERTO
PROP. FONDEPES
CONT. CONSORCIO MARITIMO DEL NORTE
SUP. CESEL

FORMULA POLINÓMICA N° 03:

EDIFICIO EN TIERRA ARQUITECTURA

AMORTIZACIÓN Y DEDUCCIÓN DEL ADELANTO DIRECTO - N° 01

Monto Adelanto Directo (Sin I.G.V.): S/. 215,539.43
Fecha de Pago: Ago-2017

A/C= 12.40%

Monto Contratado (Sin I.G.V.): S/. 1,738,221.23
Monto Adelanto Directo asignado (Sin I.G.V.): S/. 173,822.12

N°	Valorización		Amortización en el mes (2) = (1)*(A/C)	Deuda (3)	Saldo al Mes (3) - (2)	"K" del Mes		"K" al Pago (AGOSTO 2017)	Coeficiente	Deducción Adelanto Directo N° 01
	Mes	Monto Total (1)				Mes	K			
01	Set-17	0.00	0.00	215,539.43	215,539.43	Ago-17	1.0193	1.019	0.0000	0.00
02	Oct-17	0.00	0.00	215,539.43	215,539.43	Set-17	1.0226	1.019	0.0032	0.00
03	Nov-17	0.00	0.00	215,539.43	215,539.43	Oct-17	0.0000	1.019	-1.0000	0.00
04	Dic-17	0.00	0.00	215,539.43	215,539.43	Nov-17	0.0000	1.019	-1.0000	0.00
05	Ene-18	0.00	0.00	215,539.43	215,539.43	Dic-17	0.0000	1.019	-1.0000	0.00
06	Feb-18	31,040.65	3,488.97	215,539.43	212,050.46	Ene-18	1.0488	1.019	0.0289	100.98
07	Mar-18	14,566.07	1,637.23	212,050.46	210,413.24	Feb-18	1.0705	1.019	0.0502	82.20
08	Abr-18	36,673.40	4,122.09	210,413.24	206,291.15	Mar-18	1.0721	1.019	0.0517	213.23
09	May-18	18,730.19	2,105.27	206,291.15	204,185.87	Abr-18	1.0458	1.019	0.0260	54.73
10	Jun-18	51,186.57	5,753.37	204,185.87	198,432.50	May-18	1.0507	1.019	0.0308	177.35
11	Jul-18	49,037.85	5,511.86	198,432.50	192,920.65	Jun-18	1.0510	1.019	0.0310	171.03
12	Ago-18	87,261.74	9,808.22	192,920.65	183,112.43	Jul-18	1.0518	1.019	0.0319	312.94
13	Set-18	34,748.19	4,079.44	183,112.43	179,032.99	Ago-18	1.0715	1.019	0.0512	208.85
14	Oct-18	70,095.06	8,229.16	179,032.99	170,803.83	Set-18	1.0737	1.019	0.0533	438.83
15	Nov-18	76,668.78	9,169.59	170,803.83	161,634.24	Oct-18	1.0762	1.019	0.0558	511.41
16	Dic-18	6,914.26	826.95	161,634.24	160,807.29	Nov-18	1.0791	1.019	0.0586	48.48
17	Ene-19	97,408.39	12,078.64	160,807.29	148,728.65	Dic-18	1.0792	1.019	0.0588	709.78
18	Feb-19	68,016.74	8,434.08	148,728.65	140,294.57	Dic-18	1.0751	1.019	0.0547	461.29
Total		642,347.90	75,244.86							3,491.10

(*) : IU conocido hasta el momento

Acumulado Total	3,491.10
Acumulado Anterior	3,029.81
Deducción del mes	461.29

Amortización Actual Febrero 2019)

8,434.08

Deducción Actual (Febrero 2019)

461.29

CONSORCIO MARITIMO DEL NORTE
DESEMBARCADERO ARTESANAL DE SUPE
DANIEL JOAQUIN MORALES VIVAZCO
RESIDENTE DE OBRA
REG. CIP N° 98098

000300



VALORIZACIÓN N° 18 DEL 01 AL 28 DE FEBRERO DE 2019
(PRECIOS UNITARIOS)



Contrato N° 025-2017- FONDEPES Ejecucion de la Obra: MEJORAMIENTO DE LOS SERVICIOS DEL DESEMBARCADERO PESQUERO ARTESANAL DE SUPE, REGION LIMA, PROVINCIA DE BARRANCA, DISTRITO DE SUPE PUERTO



OBRA: MEJORAMIENTO DE LOS SERVICIOS DEL DESEMBARCADERO PESQUERO ARTESANAL DE SUPE ,REGION LIMA, PROVINCIA DE BARRANCA, DISTRITO DE SUPE PUERTO
PROP. FONDEPES
CONT. CONSORCIO MARITIMO DEL NORTE
SUP. CESEL

FORMULA POLINÓMICA N° 04:

EDIFICIO EN TIERRA INSTALACIONES ELECTRICAS

AMORTIZACIÓN Y DEDUCCIÓN DEL ADELANTO DIRECTO - N° 01

Monto Adelanto Directo (Sin I.G.V.): S/. 80,972.44
Fecha de Pago: Ago-2017

A/C= 12.40%

Monto Contratado (Sin I.G.V.): S/. 653,003.57
Monto Adelanto Directo asignado (Sin I.G.V.): S/. 65,300.36

N°	Valorización		Amortización en el mes (2) = (1)*(A/C)	Deuda (3)	Saldo al Mes (3) - (2)	"K" del Mes		"K" al Pago (AGOSTO 2017)	Coeficiente	Deducción Adelanto Directo N° 01
	Mes	Monto Total (1)				Mes	K			
01	Set-17	0.00	0.00	80,972.44	80,972.44	Ago-17	0.9184	1.0152	-0.0954	0.00
02	Oct-17	0.00	0.00	80,972.44	80,972.44	Set-17	0.9299	1.0152	-0.0840	0.00
03	Nov-17	0.00	0.00	80,972.44	80,972.44	Oct-17	0.0000	1.0152	-1.0000	0.00
04	Dic-17	0.00	0.00	80,972.44	80,972.44	Nov-17	0.0000	1.0152	-1.0000	0.00
05	Ene-18	0.00	0.00	80,972.44	80,972.44	Dic-17	0.0000	1.0152	-1.0000	0.00
06	Feb-18	0.00	0.00	80,972.44	80,972.44	Ene-18	0.0000	1.0152	-1.0000	0.00
07	Mar-18	7,886.62	886.46	80,972.44	80,085.98	Feb-18	0.9432	1.0152	-0.0709	
08	Abr-18	11,492.27	1,291.73	80,085.98	78,794.25	Mar-18	0.9445	1.0152	-0.0697	
09	May-18	10,808.63	1,214.89	78,794.25	77,579.36	Abr-18	0.9439	1.0152	-0.0703	
10	Jun-18	0.00	0.00	77,579.36	77,579.36	May-18	0.9515	1.0152	-0.0628	0.00
11	Jul-18	5,540.78	622.78	77,579.36	76,956.58	Jun-18	0.9543	1.0152	-0.0600	
12	Ago-18	-330.60	-37.16	76,956.58	76,993.74	Jul-18	0.9541	1.0152	-0.0602	2.24
13	Set-18	327.98	38.50	76,993.74	76,955.24	Ago-18	0.9613	1.0152	-0.0531	22.10
14	Oct-18	-3,075.48	-361.06	76,955.24	77,316.30	Set-18	0.9623	1.0152	-0.0522	23.17
15	Nov-18	0.00	0.00	77,316.30	77,316.30	Oct-18	0.9666	1.0152	-0.0479	0.00
16	Dic-18	0.00	0.00	77,316.30	77,316.30	Nov-18	0.9678	1.0152	-0.0467	0.00
17	Ene-19	2,764.29	342.77	77,316.30	76,973.53	Dic-18	0.9713	1.0152	-0.0433	
18	Feb-19	0.00	0.00	76,973.53	76,973.53	Dic-18	0.9700	1.0152	-0.0445	0.00
Total		35,414.48	3,998.91							-242.97

(*) : IU conocido hasta el momento

Acumulado Total	-242.97
Acumulado Anterior	-242.97
Deducción del mes	0.00

Amortización Actual Febrero 2019)

0.00

Deducción Actual (Febrero 2019)

0.00

CONSORCIO MARITIMO DEL NORTE
DESEMBARCADERO ARTESANAL DE SUPE

DANIEL JOAQUIN MORALES VIVA VCO
RESIDENTE DE OBRA
REG. CIP N° 98098

000335



VALORIZACIÓN N° 18 DEL 01 AL 28 DE FEBRERO DE 2019
(PRECIOS UNITARIOS)



Contrato N° 025-2017- FONDEPES Ejecucion de la Obra: MEJORAMIENTO DE LOS SERVICIOS DEL DESEMBARCADERO PESQUERO ARTESANAL DE SUPE, REGION LIMA, PROVINCIA DE BARRANCA, DISTRITO DE SUPE PUERTO



OBRA: MEJORAMIENTO DE LOS SERVICIOS DEL DESEMBARCADERO PESQUERO ARTESANAL DE SUPE ,REGION LIMA, PROVINCIA DE BARRANCA, DISTRITO DE SUPE PUERTO
PROP. FONDEPES
CONT. CONSORCIO MARITIMO DEL NORTE
SUP. CESEL
FORMULA POLINOMICA N° 05:

EDIFICIO EN TIERRA INSTALACIONES SANITARIAS
AMORTIZACION Y DEDUCCION DEL ADELANTO DIRECTO - N° 01

Monto Adelanto Directo (Sin I.G.V.): S/. 101,795.39
Fecha de Pago: Ago-2017

A/C= 12.40%

Monto Contratado (Sin I.G.V.): S/. 820,930.60
Monto Adelanto Directo asignado (Sin I.G.V.): S/. 82,093.06

N°	Valorización		Amortización en el mes (2) = (1)*(A/C)	Deuda (3)	Saldo al Mes (3) - (2)	"K" del Mes		"K" al Pago (AGOSTO 2017)	Coeficiente	Deducción Adelanto Directo N° 01
	Mes	Monto Total (1)				Mes	K			
01	Set-17	0.00	0.00	101,795.39	101,795.39	Ago-17	1.1389	1.006	0.1326	0.00
02	Oct-17	0.00	0.00	101,795.39	101,795.39	Set-17	1.1396	1.006	0.1322	0.00
03	Nov-17	0.00	0.00	101,795.39	101,795.39	Oct-17	0.0000	1.006	-1.0000	0.00
04	Dic-17	0.00	0.00	101,795.39	101,795.39	Nov-17	0.0000	1.006	-1.0000	0.00
05	Ene-18	0.00	0.00	101,795.39	101,795.39	Dic-17	0.0000	1.006	-1.0000	0.00
06	Feb-18	0.00	0.00	101,795.39	101,795.39	Ene-18	0.0000	1.006	-1.0000	0.00
07	Mar-18	4,508.32	506.74	101,288.65	101,288.65	Feb-18	1.1503	1.006	0.1439	72.94
08	Abr-18	0.00	0.00	101,288.65	101,288.65	Mar-18	1.1544	1.006	0.1480	0.00
09	May-18	8,359.00	939.55	101,288.65	100,349.10	Abr-18	1.1543	1.006	0.1480	139.04
10	Jun-18	0.00	0.00	100,349.10	100,349.10	May-18	1.1600	1.006	0.1537	0.00
11	Jul-18	3,876.38	435.71	100,349.10	99,913.39	Jun-18	1.1617	1.006	0.1553	67.68
12	Ago-18	908.49	102.11	99,913.39	99,811.28	Jul-18	1.1625	1.006	0.1561	15.94
13	Set-18	0.00	0.00	99,811.28	99,811.28	Ago-18	1.1789	1.006	0.1724	
14	Oct-18	4,289.91	503.64	99,811.28	99,307.64	Set-18	1.1823	1.006	0.1758	84.01
15	Nov-18	0.00	0.00	99,307.64	99,307.64	Oct-18	1.1831	1.006	0.1766	0.00
16	Dic-18	84,390.65	10,093.12	99,307.64	89,214.52	Nov-18	1.1851	1.006	0.1786	1,802.22
17	Ene-19	9,524.77	1,181.07	89,214.52	88,033.45	Dic-18	1.1817	1.006	0.1752	206.97
18	Feb-19	941.86	116.79	88,033.45	87,916.66	Dic-18	1.1781	1.006	0.1716	20.04
Total		116,799.38	13,878.73							2,329.71

(*) : IU conocido hasta el momento

Acumulado Total	2,329.71
Acumulado Anterior	2,309.67
Deducción del mes	20.04

Amortización Actual Febrero 2019)

116.79

Deducción Actual (Febrero 2019)

20.04

CONSORCIO MARITIMO DEL NORTE
DESEMBARCADERO ARTESANAL DE SUPE
DAMEL JOAQUIN MORALES VIVICO
RESIDENTE DE OBRA
REG. CIP N° 98098

10000331



VALORIZACIÓN N° 18 DEL 01 AL 28 DE FEBRERO DE 2019
(PRECIOS UNITARIOS)



Contrato N° 025-2017- FONDEPES Ejecucion de la Obra: MEJORAMIENTO DE LOS SERVICIOS DEL DESEMBARCADERO PESQUERO ARTESANAL DE SUPE, REGION LIMA, PROVINCIA DE BARRANCA, DISTRITO DE SUPE PUERTO



OBRA: MEJORAMIENTO DE LOS SERVICIOS DEL DESEMBARCADERO PESQUERO ARTESANAL DE SUPE ,REGION LIMA, PROVINCIA DE BARRANCA, DISTRITO DE SUPE PUERTO
 PROP. FONDEPES
 CONT. CONSORCIO MARITIMO DEL NORTE
 SUP. CESEL

FORMULA POLINÓMICA N° 06:

EDIFICIO EN TIERRA EQUIPAMIENTO

AMORTIZACIÓN Y DEDUCCIÓN DEL ADELANTO DIRECTO - N° 01

Monto Adelanto Directo (Sin I.G.V.): S/. 294,302.10
 Fecha de Pago: Ago-2017

Monto Contratado (Sin I.G.V.): S/. 2,373,404.06
 A/C= 12.40%
 Monto Adelanto Directo asignado (Sin I.G.V.): S/. 237,340.41

N°	Valorización		Amortización en el mes (2) = (1)*(A/C)	Deuda (3)	Saldo al Mes (3) - (2)	"K" del Mes		"K" al Pago (AGOSTO 2017)	Coeficiente	Deducción Adelanto Directo N° 01
	Mes	Monto Total (1)				Mes	K			
01	Set-17									
02	Oct-17									
03	Nov-17									
04	Dic-17									
05	Ene-18									
06	Feb-18									
07	Mar-18									
08	Abr-18									
09	May-18									
10	Jun-18	0.00	0.00	237340.41	237340.058	May-18	1.01755772	0.994992372	0.0227	0.00
11	Jul-18	0.00	0.00	237341.41	237340.058	Jun-18	1.01755772	0.994992372	0.0227	0.00
12	Ago-18	1,378,948.60	154,993.82	237341.41	237340.058	Jul-18	1.02132405	0.994992372	0.0265	4,101.79
13	Set-18	0.00	0.00	237341.41	237340.058	Ago-18	1.02942566	0.994992372	0.0346	0.00
14	Oct-18	0.00	0.00	237341.41	237340.058	Set-18	1.03800019	0.994992372	0.0432	0.00
15	Nov-18	0.00	0.00	237341.41	237340.058	Oct-18	1.04635497	0.994992372	0.0516	0.00
16	Dic-18	0.00	0.00	237341.41	237340.058	Nov-18	1.05970395	0.994992372	0.0650	0.00
17	Ene-19	0.00	0.00	237341.41	237340.058	Dic-18	1.05935838	0.994992372	0.0647	0.00
18	Feb-19	0.00	0.00	237341.41	237340.058	Dic-18	1.05935838	0.994992372	0.0647	0.00
Total		1,378,948.60	154,993.82							4,101.79

(*) : IU conocido hasta el momento

Acumulado Total	4,101.79
Acumulado Anterior	4,101.79
Deducción del mes	0.00

Amortización Actual Febrero 2019)

0.00

Deducción Actual (Febrero 2019)

0.00

CONSORCIO MARITIMO DEL NORTE
 DESEMBARCADERO ARTESANAL DE SUPE
 DANIEL JOAQUIN MORALES VIVICOCO
 RESIDENTE DE OBRA
 REG. CIP N° 98058

000333



VALORIZACIÓN N° 18 DEL 01 AL 28 DE FEBRERO DE 2019
(PRECIOS UNITARIOS)



Contrato N° 025-2017- FONDEPES Ejecución de la Obra: MEJORAMIENTO DE LOS SERVICIOS DEL DESEMBARCADERO PESQUERO ARTESANAL DE SUPE, REGION LIMA, PROVINCIA DE BARRANCA, DISTRITO DE SUPE PUERTO



OBRA: MEJORAMIENTO DE LOS SERVICIOS DEL DESEMBARCADERO PESQUERO ARTESANAL DE SUPE ,REGION LIMA, PROVINCIA DE BARRANCA, DISTRITO DE SUPE PUERTO
PROP. FONDEPES
CONT. CONSORCIO MARITIMO DEL NORTE
SUP. CESEL

FORMULA POLINÓMICA N° 07:

IMPACTO AMBIENTAL

AMORTIZACIÓN Y DEDUCCIÓN DEL ADELANTO DIRECTO - N° 01

Monto Adelanto Directo (Sin I.G.V.): S/. 6,690.74
Fecha de Pago: Ago-2017

Monto Contratado (Sin I.G.V.): S/. 53,957.61
Monto Adelanto Directo asignado (Sin I.G.V.): S/. 5,395.76

A/C= 12.40%

Valorización			Amortización en el mes (2) = (1)*(A/C)	Deuda al Mes Anterior (3)	Saldo al Mes (3) - (2)	"K" del Mes		"K" al Pago (AGOSTO 2017)	Coeficiente	Deducción Adelanto Directo N° 01
N°	Mes	Monto Total (1)				Mes	K			
01	Set-17	11,730.38	1,173.04	5,395.76	4,222.72	Ago-17	1.011	1.011	0.0000	0.00
02	Oct-17	6,602.88	660.29	4,222.72	3,562.43	Set-17	1.012	1.011	0.0003	0.19
03	Nov-17	1,696.97	169.70	3,562.43	3,392.73	Oct-17	1.006	1.011	-0.0049	
04	Dic-17	3,106.81	310.68	3,392.73	3,082.05	Nov-17	1.006	1.011	-0.0053	
05	Ene-18	1,825.80	205.22	3,082.05	2,876.83	Dic-17	1.006	1.011	-0.0050	
06	Feb-18	1,114.13	125.23	2,876.83	2,751.60	Ene-18	1.006	1.011	-0.0050	
07	Mar-18	1,398.60	157.23	2,751.60	2,594.37	Feb-18	1.006	1.011	-0.0048	
08	Abr-18	1,114.13	125.23	2,594.37	2,469.14	Mar-18	1.011	1.011	0.0001	0.02
09	May-18	4,353.49	489.33	2,469.14	1,979.81	Abr-18	1.010	1.011	-0.0008	
10	Jun-18	2,276.85	255.92	1,979.81	1,723.89	May-18	1.018	1.011	0.0062	1.59
11	Jul-18	675.35	75.91	1,723.89	1,647.98	Jun-18	1.017	1.011	0.0060	0.45
12	Ago-18	447.25	50.27	1,647.98	1,597.71	Jul-18	1.018	1.011	0.0064	0.32
13	Set-18	1,572.41	184.60	1,597.71	1,413.11	Ago-18	1.030	1.011	0.0182	3.36
14	Oct-18	59.63	7.00	1,413.11	1,406.11	Set-18	1.035	1.011	0.0237	0.17
15	Nov-18	29.82	3.57	1,406.11	1,402.54	Oct-18	1.032	1.011	0.0210	0.07
16	Dic-18	29.82	3.57	1,402.54	1,398.97	Nov-18	1.032	1.011	0.0210	0.07
17	Ene-19	0.00	3.70	1,398.97	1,395.27	Dic-18	1.032	1.011	0.0210	0.08
18	Feb-19	0.00	0.00	1,395.27	1,395.27	Dic-18	1.030	1.011	0.0186	0.00
Total		38,034.52	4,000.49							1.04

(*) : IU conocido hasta el momento

Acumulado Total	1.04
Acumulado Anterior	1.04
Deducción del mes	0.00

Amortización Actual Febrero 2019)

0.00

Deducción Actual (Febrero 2019)

CONSORCIO MARITIMO DEL NORTE
DESEMBARCADERO ARTESANAL DE SUPE
[Firma]
DANIEL JOAQUIN MORALES VIVAYCO
RESIDENTE DE OBRA
REG. CIP N° 98098

000332



VALORIZACIÓN N° 18 DEL 01 AL 28 DE FEBRERO DE 2019
(PRECIOS UNITARIOS)



AMORTIZACION Y DEDUCCION QUE NO CORRESPONDE POR EL ADELANTO DE MATERIALES

OBRA: MEJORAMIENTO DE LOS SERVICIOS DEL DESEMBARCADERO PESQUERO ARTESANAL DE SUPE, REGION LIMA, PROVINCIA DE BARRANCA, DISTRITO DE SUPE PUERTO
 PROP: FONDEPES
 CONTRAT: CONSORCIO MARITIMO DEL NORTE
 SUPERV: CESEL

ITEM	DESCRIPCION	Itm	Imo	N° VALORIZACION	MES	Imr	VALORIZACION EJECUTADA	ADELANTO OTORGADO	ADELANTO DEFECTADO A LA FECHA BASE	INDICE DE LA FORMULA POLINOMICA	MONTO UTILIZABLE EN LA VALORIZACION	MONTO UTILIZADO ACUMULADO	DEDUCCION		
0202000008 03	ACERO DE CONSTRUCCION CORRUGADO	42.17	431.67	01	SET	457.17	-	-	-	0.129	-	-	-		
				02	OCT	457.17	-	-	-	0.130	-	-	-	-	-
				03	NOV	458.62	967,670.31	-	-	0.130	110,630.67	110,630.57	704.43		
				04	DEC	454.75	1,095,617.05	-	-	0.130	17,869.70	130,656.27	-100.13		
				05	JAN	472.49	53,320.79	-	-	0.130	6,879.37	136,573.04	94.73		
				06	FEB	475.87	253,257.64	-	-	1.133	266,339.17	431,312.91	5,700.23		
				07	MAR	507.31	246,884.19	-	-	0.129	31,848.00	463,160.67	2,552.12		
				08	APR	506.47	51,811.01	-	-	0.130	8,993.75	469,844.02	606.22		
				09	MAY	501.99	131,196.47	-	-	0.130	15,234.34	478,478.07	1,200.17		
				10	JUN	513.58	134,191.86	-	-	0.130	17,310.75	492,789.73	1,600.20		
				11	JUL	508.81	198,055.29	-	-	0.129	25,543.13	619,336.65	2,403.59		
				12	AUG	512.37	129,581.60	-	-	0.129	13,401.00	631,628.90	1,411.50		
				13	SEP	525.48	10,478.58	-	-	0.130	1,351.14	630,181.61	182.51		
				14	OCT	527.67	49,354.83	-	-	0.130	8,840.77	642,729.30	1,257.00		
				15	NOV	531.71	13,917.26	-	-	0.130	1,707.61	642,628.20	289.88		
				16	DEC	531.71	271,189.75	-	-	0.130	34,293.46	678,929.77	6,239.94		
				17	JAN	542.08	32,737.65	-	-	0.129	4,223.16	680,132.93	732.53		
				18	FEB	537.43	33,906.12	-	-	0.129	4,573.80	687,506.82	711.59		
				SUB TOTAL							2,591,001.34				

ITEM	DESCRIPCION	Itm	Imo	N° VALORIZACION	MES	Imr	VALORIZACION EJECUTADA	ADELANTO OTORGADO	ADELANTO DEFECTADO A LA FECHA BASE	INDICE DE LA FORMULA POLINOMICA	MONTO UTILIZABLE EN LA VALORIZACION	MONTO UTILIZADO ACUMULADO	DEDUCCION		
0202000008 5	AGREGADO GRUESO	216.04	219.29	01	SET										
				02	OCT										
				03	NOV										
				04	DEC										
				05	JAN										
				06	FEB										
				07	MAR										
				08	APR										
				09	MAY	216.64	121,196.47	-	-	0.212	25,691.65	25,691.65	-		
				10	JUN	216.60	134,191.86	-	-	0.212	26,449.07	64,142.30	5,213.2		
				11	JUL	216.69	139,055.29	-	-	0.212	41,897.72	86,130.05	9,617.9		
				12	AUG	216.64	384,581.69	-	-	0.212	22,171.30	119,301.36	-		
				13	SEP	216.30	10,478.58	-	-	0.212	2,221.42	130,522.80	3,492.2		
				14	OCT	215.63	69,154.81	-	-	0.212	14,703.22	146,226.03	-6,669.9		
				15	NOV	215.69	13,917.26	-	-	0.212	2,564.70	149,180.73	-12,656.6		
				16	DEC	215.69	271,189.75	-	-	0.212	57,432.23	195,872.96	-260,219.1		
				17	JAN	215.77	32,737.65	-	-	0.212	6,640.59	202,613.51	-27,623.9		
				18	FEB	215.77	33,906.12	-	-	0.212	7,198.10	209,811.43	-39,646.6		
				SUB TOTAL							989,629.40				
SUB TOTAL							6,171,632.03							38,207.57	

Acumulado Total	38,207.57
Acumulado Anterior	37,167.88
Deducción del mes	1,039.69

DEDUCCION DEL MES DE ENERO 2019 FORMULA POLINOMICA N°02 1,039.69

FORMULA POLINOMICA N° 03:															
MATERIALES															
ITEM	DESCRIPCION	Itm	Imo	N° VALORIZACION	MES	Imr	VALORIZACION EJECUTADA	ADELANTO OTORGADO	ADELANTO DEFECTADO A LA FECHA BASE	INDICE DE LA FORMULA POLINOMICA	MONTO UTILIZABLE EN LA VALORIZACION	MONTO UTILIZADO ACUMULADO	DEDUCCION		
0202000007 23	CEMENTO PORTLAND TIPO V	410.10	410.10	01	SET										
				02	OCT										
				03	NOV										
				04	DEC										
				05	JAN										
				06	FEB										
				07	MAR										
				08	APR										
				09	MAY										
				10	JUN										
				11	JUL										
				12	AUG	439.25	87,261.74	-	-	0.146	12,740.21	12,740.21	644.48		
				13	SEP	439.25	34,748.19	-	-	0.146	5,073.24	17,813.45	226.69		
				14	OCT	439.25	70,095.05	-	-	0.146	10,293.68	28,107.30	517.69		
				15	NOV	439.25	76,668.78	-	-	0.146	11,180.64	39,287.97	598.24		
				16	DEC	439.25	6,914.26	-	-	0.146	1,039.48	40,290.45	51.07		
				17	JAN	439.25	97,468.40	-	-	0.146	14,271.69	54,562.14	718.41		
				18	FEB	439.25	68,016.74	-	-	0.146	9,930.44	64,492.62	632.34		
				SUB TOTAL							441,113.17				

Acumulado Total	3,257.86
Acumulado Anterior	2,755.52
Deducción del mes	502.34

DEDUCCION DEL MES DE ENERO 2019 FORMULA POLINOMICA N°03 502.34

CONSORCIO MARITIMO DEL NORTE
 DESEMBARCADERO ARTESANAL DE SUPE

DANIEL JOAQUIN MORALES VIVÓ
 RESIDENTE DE OBRA
 REG. CIP N° 98098



VALORIZACIÓN N° 18 DEL 01 AL 28 DE FEBRERO DE 2019
(PRECIOS UNITARIOS)



AMORTIZACION Y DEDUCCION QUE NO CORRESPONDE POR EL ADELANTO DE MATERIALES

OBRA: MEJORAMIENTO DE LOS SERVICIOS DEL DESEMBARCADERO PESQUERO ARTESANAL DE SUPE, REGION LIMA, PROVINCIA DE BARRANCA, DISTRITO DE SUPE PUERTO
 PROP. FONDEPES
 CONTRAT. CONSORCIO MARITIMO DEL NORTE
 SUPERV. CESEL

ITEM	DESCRIPCION	lma	lmo	N° VALORIZACION	MES	lme	VALORIZACION EJECUTADA	ADELANTO OTORGADO	ADELANTO DEFALCTADO A LA FECHA BASE	INDICE DE LA FORMULA POLINOMICA	MONTO UTILIZABLE EN LA VALORIZACION	MONTO UTILIZADO ACUMULADO	DEDUCCION
FORMULA POLINOMICA N° 01:													
MATERIALES													

020200007	CEMENTO PORTLAND TIPO V	418 10	418 10	01	SET	418 10	-	-	-	0.145	-	-	-
23				02	OCT	418 10	644,267.40			0.145	123,276.19	123,276.19	-
				03	NOV	418 10	382,242.78			0.145	57,257.45	180,533.64	-
				04	DEC	418 10	1,197,259.49			0.145	173,338.98	353,872.62	-
				05	JAN	418 10	338,838.47			0.145	47,803.02	401,675.64	-
				06	FEB	418 10	153,293.00			0.145	22,240.79	423,916.43	-
				07	MAR	439.25	-75,259.47			0.145	-10,989.34	412,927.09	426.91
				08	APR	439.25	29,558.99			0.145	4,375.61	417,302.70	748.31
				09	MAY	439.25	21,343.47			0.145	3,118.15	420,420.85	157.03
				10	JUN	439.25	67,013.77			0.145	12,764.01	433,184.86	642.64
				11	JUL	439.25	47,706.78			0.145	8,266.19	441,451.05	323.34
				12	AUG	439.25	20,567.19			0.145	3,002.81	444,453.86	151.30
				13	SEP	439.25	-			0.145	-	444,453.86	-
				14	OCT	439.25	-			0.145	-	444,453.86	-
				15	NOV	439.25	110,459.82			0.145	16,127.13	460,580.99	616.81
				16	DEC	439.25	22,978.88			0.145	3,544.02	464,125.01	100.71
				17	JAN	439.25	31,550.09			0.145	4,608.31	468,733.32	228.01
				18	FEB	439.25	442,979.08			0.145	64,714.05	533,447.37	3,271.85
				SUB TOTAL			3,644,079.73						5,457.10

020200008	ACERO DE CONSTRUCCION CORRUGADO	427 17	427 17	01	SET	427 17	-	-	-	0.22	-	-	-
03				02	OCT	427 17	844,267.40			0.22	184,814.27	184,814.27	-
				03	NOV	427 17	372,242.78			0.22	82,601.17	267,415.44	540.09
				04	DEC	427 17	1,197,259.49			0.22	263,000.69	530,416.13	1,459.07
				05	JAN	427 17	338,838.47			0.22	74,940.43	605,356.56	884.67
				06	FEB	427 17	153,293.00			0.22	33,571.07	638,927.63	676.29
				07	MAR	439.25	-75,259.47			0.22	-16,494.01	622,433.62	1,341.84
				08	APR	439.25	29,558.99			0.22	6,473.42	628,907.04	500.08
				09	MAY	439.25	21,343.47			0.22	4,655.68	633,562.72	379.46
				10	JUN	439.25	67,013.77			0.22	14,810.03	648,372.75	2,067.17
				11	JUL	439.25	47,706.78			0.22	10,465.43	658,838.18	1,019.96
				12	AUG	439.25	20,567.19			0.22	4,524.76	663,362.94	473.57
				13	SEP	439.25	-			0.22	-	663,362.94	-
				14	OCT	439.25	-			0.22	-	663,362.94	-
				15	NOV	439.25	110,459.82			0.22	24,301.16	687,664.10	3,621.84
				16	DEC	439.25	22,978.88			0.22	5,055.35	692,719.45	755.47
				17	JAN	439.25	31,550.09			0.22	6,941.02	700,660.47	1,200.95
				18	FEB	439.25	442,979.08			0.22	97,466.45	798,126.92	5,064.81
				SUB TOTAL			3,644,079.73						25,265.77

SUB TOTAL	7,288,159.46	-	-	-	30,722.87
-----------	--------------	---	---	---	-----------

Acumulado Total	30,722.87
Acumulado Anterior	11,596.42
Deducción del mes	19,126.45

DEDUCCION DEL MES DE FEBRERO 2019 FÓRMULA POLINÓMICA N°01 19,126.45

FORMULA POLINOMICA N° 02:													
MATERIALES													

020200007	CEMENTO PORTLAND TIPO V	418 10	418 10	01	SET	418 10	-	-	-	0.21	-	-	-
23				02	OCT	418 10	-			0.21	-	-	-
				03	NOV	418 10	667,670.31			0.21	178,374.62	178,374.62	-
				04	DEC	418 10	138,617.06			0.21	28,811.66	207,186.28	-
				05	JAN	418.10	51,320.73			0.21	11,060.71	218,247.00	-
				06	FEB	418.10	253,267.84			0.21	62,679.67	280,926.67	-
				07	MAR	439.25	248,884.19			0.21	51,261.91	332,188.58	2,557.00
				08	APR	439.25	31,812.01			0.21	10,170.90	342,359.48	546.18
				09	MAY	439.25	121,196.47			0.21	25,209.87	367,569.35	1,275.22
				10	JUN	439.25	134,191.86			0.21	27,811.01	395,380.36	1,411.95
				11	JUL	439.25	198,055.29			0.21	41,664.02	437,044.38	2,083.91
				12	AUG	439.25	104,581.60			0.21	21,752.07	458,796.45	1,100.40
				13	SEP	439.25	10,478.58			0.21	2,170.54	461,000.00	110.25
				14	OCT	439.25	69,334.83			0.21	14,425.90	475,425.90	729.74
				15	NOV	439.25	13,937.26			0.21	2,898.25	478,324.15	146.65
				16	DEC	439.25	271,189.73			0.21	58,427.47	536,751.62	2,363.43
				17	JAN	439.25	32,737.63			0.21	6,809.43	543,561.05	344.45
				18	FEB	439.25	33,906.12			0.21	7,263.47	550,824.52	392.78
				SUB TOTAL			2,591,001.34						13,555.61

CONSORCIO MARITIMO DEL NORTE
DESEMBARCADERO ARTESANAL DE SUPE

 DANIEL JOAQUÍN MORALES VIZA NCC
 RESIDENTE DE OBRA
 REG. CIP N° 98098

CALCULO DEL NUEVO % DE AMORTIZACION DEL ADELANTO DIRECTO EFECTIVO DESDE ENERO 2019

000322

1.- Monto según Contrato :

Sub Total	IGV	Total
S/. 18,228,043.83	S/. 3,281,047.85	S/. 21,509,091.68

2.- Adelanto Efectivo Otorgado :

Sub Total	IGV	Total
S/. 1,822,804.37	S/. 328,104.78	S/. 2,150,909.15

3.- % Otorgado por Adelanto Efectivo :

2,150,909.15	x 100 =	10.00%
21,509,091.68		

4.- Deductivo Vinculante N°01 (Aprobación Exped. Técnico Definitivo)

Sub Total	IGV	Total
S/. 1,532,602.85	S/. 286,658.51	S/. 1,819,261.36

5.- Monto Contratado menos deductivo N°01

Sub Total	IGV	Total
S/. 16,635,440.78	S/. 2,994,379.34	S/. 19,629,820.12

6.- Nuevo % Amortización Adelanto Efectivo: Efectivo desde Enero 2018 a Agosto 2018

1,699,340.88	x 100 =	11.24%
15,114,137.52		

7.- Deductivo Vinculante N°02 (Aprobación Exped. Técnico Definitivo)

Sub Total	IGV	Total
S/. 205,822.30	S/. 37,048.01	S/. 242,870.31

8.- Deductivo Vinculante N°03 (Aprobación Exped. Técnico Definitivo)

Sub Total	IGV	Total
S/. 186,818.62	S/. 33,531.35	S/. 220,350.97

9.- Monto Contratado menos deductivos N° 01, 02 y 03 (Aprobados mediante Exped. Técnico Definitivo)

Sub Total	IGV	Total
S/. 16,242,959.88	S/. 2,825,739.98	S/. 19,068,699.86

10.- Nuevo % Amortización Adelanto Efectivo: Efectivo desde Setiembre 2018 a Octubre 2018

1,233,760.13	x 100 =	11.74%
10,510,127.16		

11.- Deductivo Vinculante N°04 (Aprobación Exped. Técnico Definitivo)

Sub Total	IGV	Total
S/. 159,047.42	S/. 28,628.54	S/. 187,675.96

12.- Monto Contratado menos deductivos N° 01,02,03 y 04 (Aprobados mediante Exped. Técnico Definitivo)

Sub Total	IGV	Total
S/. 16,083,952.44	S/. 2,895,111.44	S/. 18,979,063.88

13.- Nuevo % Amortización Adelanto Efectivo: Efectivo desde Noviembre 2018 a Diciembre 2018

1,207,739.45	x 100 =	11.95%
10,100,766.89		

14.- Deductivo Vinculante N°05 (Aprobación Exped. Técnico Definitivo)

Sub Total	IGV	Total
S/. 287,879.29	S/. 51,818.27	S/. 339,697.56

15.- Monto Contratado menos deductivos N° 01,02,03,04 y 05 (Aprobados mediante Exped. Técnico Definitivo)

Sub Total	IGV	Total
S/. 15,796,073.15	S/. 2,843,293.17	S/. 18,639,366.32

16.- Nuevo % Amortización Adelanto Efectivo: Efectivo Enero 2019

1,124,975.47	x 100 =	12.40%
9,069,902.45		

17.- Resumen de Valorizaciones hasta Enero 2019 :

Valorización N°	Monto Valorizado	Monto Amortizado	Amortizado Acumulado	Saldo por Amortizar	% Amortizado	% Acumulado	Mes de Amortización	Observaciones
1	237,582.28		23,758.23	2,138,244.05	1.00%	1.00%	Set-17	Se aplicó 10.00% de amortización
2	1,088,853.99		100,889.40	1,939,133.59	5.53%	6.53%	Oct-17	Se aplicó 10.00% de amortización
3	1,251,510.05		125,151.01	1,813,982.58	6.87%	13.70%	Nov-17	Se aplicó 10.00% de amortización
4	1,328,883.34		132,888.33	1,681,094.25	7.29%	20.99%	Dic-17	Se aplicó 10.00% de amortización
5	383,165.00		43,082.97	1,638,011.28	2.36%	23.35%	Ene-18	Se aplicó 11.24% de amortización
6	438,715.42		49,326.47	1,588,684.81	2.71%	26.06%	Feb-18	Se aplicó 11.24% de amortización
7	189,974.53		22,483.91	1,566,200.90	1.23%	27.29%	Mar-18	Se aplicó 11.24% de amortización
8	130,650.80		14,689.57	1,551,511.33	0.81%	28.10%	Abr-18	Se aplicó 11.24% de amortización
9	184,761.25		20,778.79	1,530,732.54	1.14%	29.24%	May-18	Se aplicó 11.24% de amortización
10	274,869.05		30,882.10	1,500,850.44	1.69%	30.93%	Jun-18	Se aplicó 11.24% de amortización
11	304,892.44		34,280.24	1,466,570.20	1.68%	32.61%	Jul-18	Se aplicó 11.24% de amortización
12	1,592,384.28		179,037.92	1,287,532.28	9.83%	42.84%	Ago-18	Se aplicó 11.24% de amortización
13	47,127.16		5,532.15	1,282,000.13	0.31%	42.85%	Set-18	Se aplicó 11.74% de amortización
14	140,723.95		16,319.27	1,265,680.86	0.90%	43.85%	Oct-18	Se aplicó 11.74% de amortización
15	201,095.69		24,044.78	1,241,636.08	1.31%	45.16%	Nov-18	Se aplicó 11.99% de amortización
16	385,503.33		46,094.19	1,195,541.89	2.62%	47.88%	Dic-18	Se aplicó 11.96% de amortización
17	545,843.78		67,710.61	1,127,831.28	3.71%	51.39%	Ene-19	Se aplicó 12.46% de amortización
Acumulado	8,636,406.38		937,145.94	7,700,260.44		51.41%		

CONSORCIO MARITIMO DEL NORTE
DESEMBARCA DE BO ARTESANAL DE SUPE
DANIEL JOAQUIN MORALES VIVANCO
RESIDENTE DE OBRA
REG. CHIP N° 98098

CALCULO DEL NUEVO % DE AMORTIZACION DEL ADELANTO DIRECTO EFECTIVO DESDE ENERO 2019

000321

1.- Monto según Contrato :

Sub Total	IGV	Total
S/ 18,226,043.63	S/ 3,261,047.65	S/ 21,509,091.48

2.- Adelanto Efectivo Otorgado :

Sub Total	IGV	Total
S/ 1,622,604.37	S/ 328,104.78	S/ 2,150,909.15

3.- % Otorgado por Adelanto Efectivo :

$$\frac{2,150,909.15}{21,509,091.48} \times 100 = 10.00\%$$

4.- Deductivo Vinculante N°01
(Aprobación Exped. Técnico Definitivo)

Sub Total	IGV	Total
S/ 1,632,602.65	S/ 286,658.51	S/ 1,879,271.36

5.- Monto Contratado menos deductivo N°01

Sub Total	IGV	Total
S/ 16,635,440.78	S/ 2,994,379.34	S/ 19,629,820.12

6.- Nuevo % Amortización Adelanto Efectivo:
Efectivo desde Enero 2018 a Agosto 2018

$$\frac{1,699,340.89}{15,114,137.52} \times 100 = 11.24\%$$

7.- Deductivo Vinculante N°02
(Aprobación Exped. Técnico Definitivo)

Sub Total	IGV	Total
S/ 205,822.30	S/ 37,048.01	S/ 242,870.31

8.- Deductivo Vinculante N°03
(Aprobación Exped. Técnico Definitivo)

Sub Total	IGV	Total
S/ 186,616.62	S/ 33,591.35	S/ 220,209.87

9.- Monto Contratado menos deductivos N° 01, 02 y 03

Sub Total	IGV	Total
-----------	-----	-------

18.- Valorización Acumulada Enero 2019 :

Sub Total	IGV	Total
S/ 8,656,406.38	S/ 1,558,153.15	S/ 10,214,559.53

19.- Amortización Acumulada Enero 2019 :

Sub Total	IGV	Total
S/ 937,145.94	S/ 189,696.27	S/ 1,105,832.21

20.- Saldo por Valorizar a Enero 2019 :

Sub Total	IGV	Total
S/ 7,139,666.76	S/ 1,265,140.02	S/ 8,424,806.80

21.- Saldo por Amortizar a Enero 2019 :

Sub Total	IGV	Total
S/ 635,669.43	S/ 159,416.62	S/ 1,045,076.95

22.- Nuevo % Amortización Adelanto Efectivo:

$$\frac{1,045,076.95}{8,424,806.80} \times 100 = 12.40\%$$

CONSORCIO MARITIMO DEL NORTE
DESEMPARCADEÑO ARTESANAL DE SUPE
DANIEL JOAQUIN MORALES VIVACO
RESIDENTE DE OBRA
REG. CIP N° 98098

ÁREAS GEOGRÁFICAS													
Cód.	1	2	3	4	5	6	Cód.	1	2	3	4	5	6
59	243,79	243,79	243,79	243,79	243,79	243,79	54	432,39	432,39	432,39	432,39	432,39	432,39
61	272,11	272,11	272,11	272,11	272,11	272,11	56	585,86	585,86	585,86	585,86	585,86	585,86
65	260,27	260,27	260,27	260,27	260,27	260,27	60	295,99	295,99	295,99	295,99	295,99	295,99
69	389,45	327,82	428,87	488,52	289,39	451,51	62	469,93	469,93	469,93	469,93	469,93	469,93
71	663,87	663,87	663,87	663,87	663,87	663,87	64	348,21	348,21	348,21	348,21	348,21	348,21
73	553,34	553,34	553,34	553,34	553,34	553,34	66	721,69	721,69	721,69	721,69	721,69	721,69
77	338,48	338,48	338,48	338,48	338,48	338,48	68	269,93	269,93	269,93	269,93	269,93	269,93
							70	218,25	218,25	218,25	218,25	218,25	218,25
							72	431,72	431,72	431,72	431,72	431,72	431,72
							78	499,05	499,05	499,05	499,05	499,05	499,05
							80	108,76	108,76	108,76	108,76	108,76	108,76

(*) Sin Producción

Nota: El cuadro incluye los índices unificados de código: 30, 34, 39, 47, 49 y 53, que fueron aprobados mediante Resolución Jefatural N° 046-2019-INEI.

Artículo 2.- Las Áreas Geográficas a que se refiere el artículo 1, comprende a los siguientes departamentos:

Área 1 : Tumbes, Piura, Lambayeque, La Libertad, Cajamarca, Amazonas y San Martín

Área 2 : Ancash, Lima, Provincia Constitucional del Callao e Ica

Área 3 : Huánuco, Pasco, Junín, Huancavelica, Ayacucho y Ucayali

Área 4 : Arequipa, Moquegua y Tacna

Área 5 : Loreto

Área 6 : Cusco, Puno, Apurímac y Madre de Dios.

Artículo 3.- Los Índices Unificados de Precios, corresponden a los materiales, equipos, herramientas, mano de obra y otros elementos e insumos de la construcción, agrupados por elementos similares y/o afines. En el caso de productos industriales, el precio utilizado es el de venta ex fábrica incluyendo los impuestos de ley y sin considerar fletes.

Regístrese y comuníquese.

FRANCISCO COSTA APONTE
Jefe (e)

1742073-1

Aprueban Factores de Reajuste que debe aplicarse a las obras de edificación, correspondiente a las seis Áreas Geográficas para las Obras del Sector Privado, producidas en el mes de enero de 2019

**RESOLUCIÓN JEFATURAL
N° 056-2019-INEI**

Lima, 15 de febrero de 2019

CONSIDERANDO:

Que, de acuerdo a lo dispuesto en la Novena Disposición Complementaria y Transitoria del Decreto Ley 25862, de 18.11.92, se declara en desactivación y disolución al Consejo de Reajuste de Precios de la Construcción;

Que, asimismo la Undécima Disposición Complementaria y Transitoria del referido Decreto Ley, dispone transferir al Instituto Nacional de Estadística e Informática (INEI) las funciones de elaboración de los Índices de los elementos que determinen el costo de las Obras;

Que, para uso del Sector Privado de la Construcción, deben elaborarse los Factores de Reajuste correspondientes a las obras de Edificación de las seis

(6) Áreas Geográficas del país, aplicables a las obras en actual ejecución, siempre que sus contratos no estipulen modalidad distinta de reajuste;

Que, para tal efecto, la Dirección Técnica de Indicadores Económicos ha elaborado el Informe N° 02-01-2019/DTE, referido a los Factores de Reajuste para las Áreas Geográficas 1, 2, 3, 4, 5 y 6, correspondientes al período del 1 al 31 de Enero de 2019 y que cuenta con la conformidad de la Comisión Técnica para la Aprobación de los Índices Unificados de Precios de la Construcción, por lo que resulta necesario expedir la Resolución Jefatural pertinente, así como disponer su publicación en el diario oficial El Peruano, y;

Con las visaciones de la Sub Jefatura de Estadística; de la Dirección Técnica de Indicadores Económicos y de la Oficina Técnica de Asesoría Jurídica; y,

En uso de las atribuciones conferidas por el artículo 6 del Decreto Legislativo N° 604, Ley de Organización y Funciones del Instituto Nacional de Estadística e Informática.

SE RESUELVE:

Artículo 1.- Aprobar los Factores de Reajuste que debe aplicarse a las obras de edificación, correspondiente a las seis (6) Áreas Geográficas para las Obras del Sector Privado, derivados de la variación de precios de todos los elementos que intervienen en el costo de dichas obras, producidas en el período del 1 al 31 de Enero de 2019, según se detalla en el cuadro siguiente:

ÁREAS GEOGRÁFICAS No.	OBRAS DE EDIFICACIÓN											
	Edificación de 1 y 2 Pisos			Edificación de 1 y 2 Pisos			Edificación de 3 y 4 Pisos			Edificación de 3 y 4 Pisos		
	(Terminada)			(Casco Vestido)			(Terminada)			(Casco Vestido)		
	M.O.	Resto Elem.	Total	M.O.	Resto Elem.	Total	M.O.	Resto Elem.	Total	M.O.	Resto Elem.	Total
1	0,9992	1,0001	0,9993	0,9991	0,9990	0,9981	0,9992	0,9998	0,9990	0,9990	0,9990	0,9980
2	0,9992	1,0006	0,9998	0,9991	0,9995	0,9986	0,9993	0,9999	0,9992	0,9990	0,9993	0,9983
3	0,9993	1,0011	1,0004	0,9992	1,0009	1,0001	0,9993	1,0007	1,0000	0,9991	1,0004	0,9995
4	0,9992	0,9997	0,9989	0,9991	0,9990	0,9981	0,9992	0,9996	0,9988	0,9990	0,9988	0,9978
5	0,9992	1,0007	0,9999	0,9991	1,0005	0,9996	0,9993	1,0005	0,9998	0,9990	1,0001	0,9991
6	0,9992	1,0011	1,0003	0,9991	1,0009	1,0000	0,9993	1,0009	1,0002	0,9990	1,0006	0,9996

000318

ANEXO N°01

OBRAS PORTUARIAS

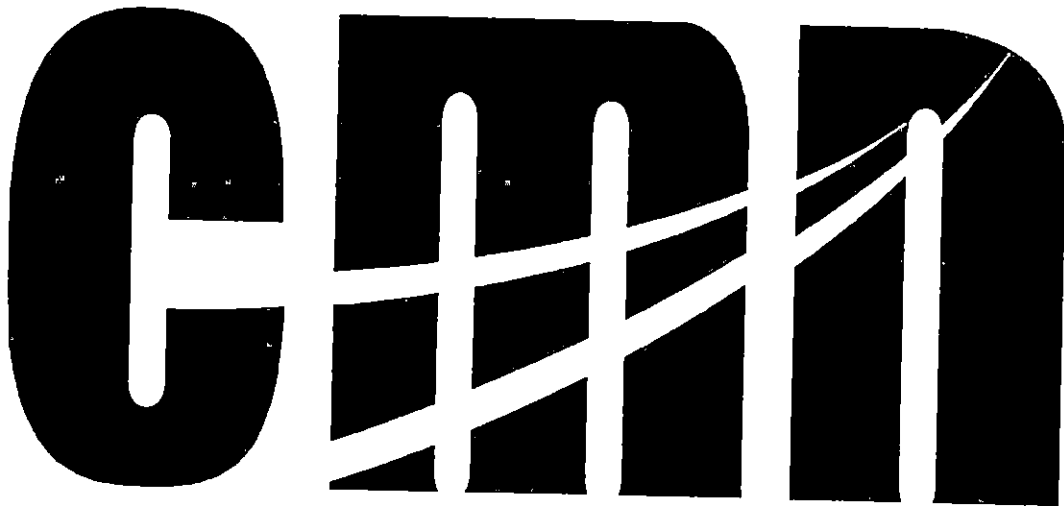

CONSORCIO MARTIMO DEL NORTE

“Mejoramiento y Recuperación de los servicios del Desembarcadero Pesquero Artesanal de Supe,
Distrito de Supe Puerto, Provincia de Barranca, Región Lima”

FEBRERO

2019

CONSORCIO MARTIMO DEL NORTE
DESEMARCADERO ARTESANAL DE SUPE
DANIEL JOAQUIN MORALES VIVA VCO
RESIDENTE DE OBRA
REG. CIP N° 98098

01 OBRAS PORTUARIAS

000317

01.02 MUELLE TIPO ESPIGÓN

01.02.01 FABRICACIÓN DE PILOTES DE CONCRETO

01.02.01.01 CONCRETO DE PILOTES $f'c=350\text{kg/cm}^2$

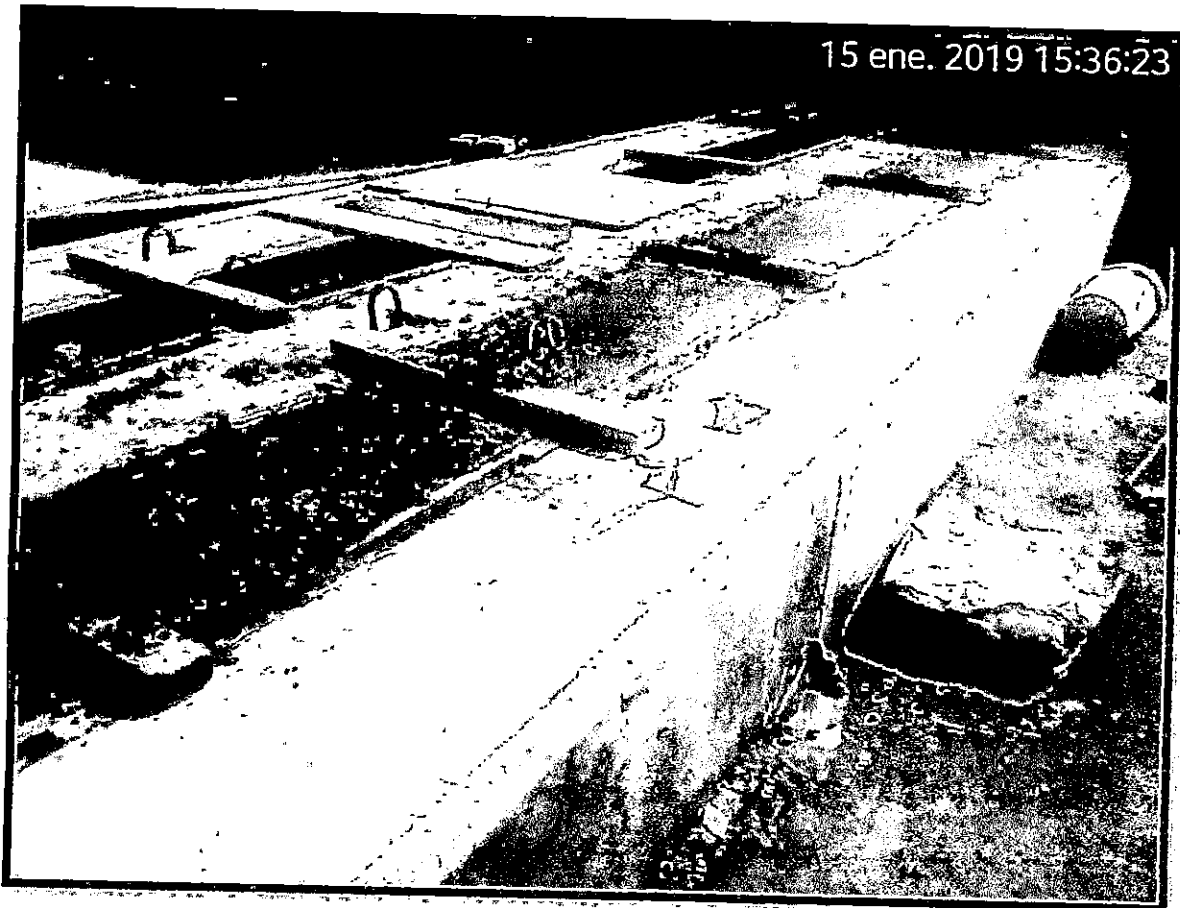

CONSORCIO MARITIMO DEL NORTE
DESEMBARCADERO ARTESANAL DE SUPE
DANIEL JOAQUIN MORALES VIVA VCC
RESIDENTE DE OBRA
REG. CIP N° 98098

000316

01 OBRAS PORTUARIAS

01.02 MUELLE TIPO ESPIGÓN

01.02.01 FABRICACIÓN DE PILOTES DE CONCRETO

01.02.01.02 ENCOFRADO Y DESENCOFRADO

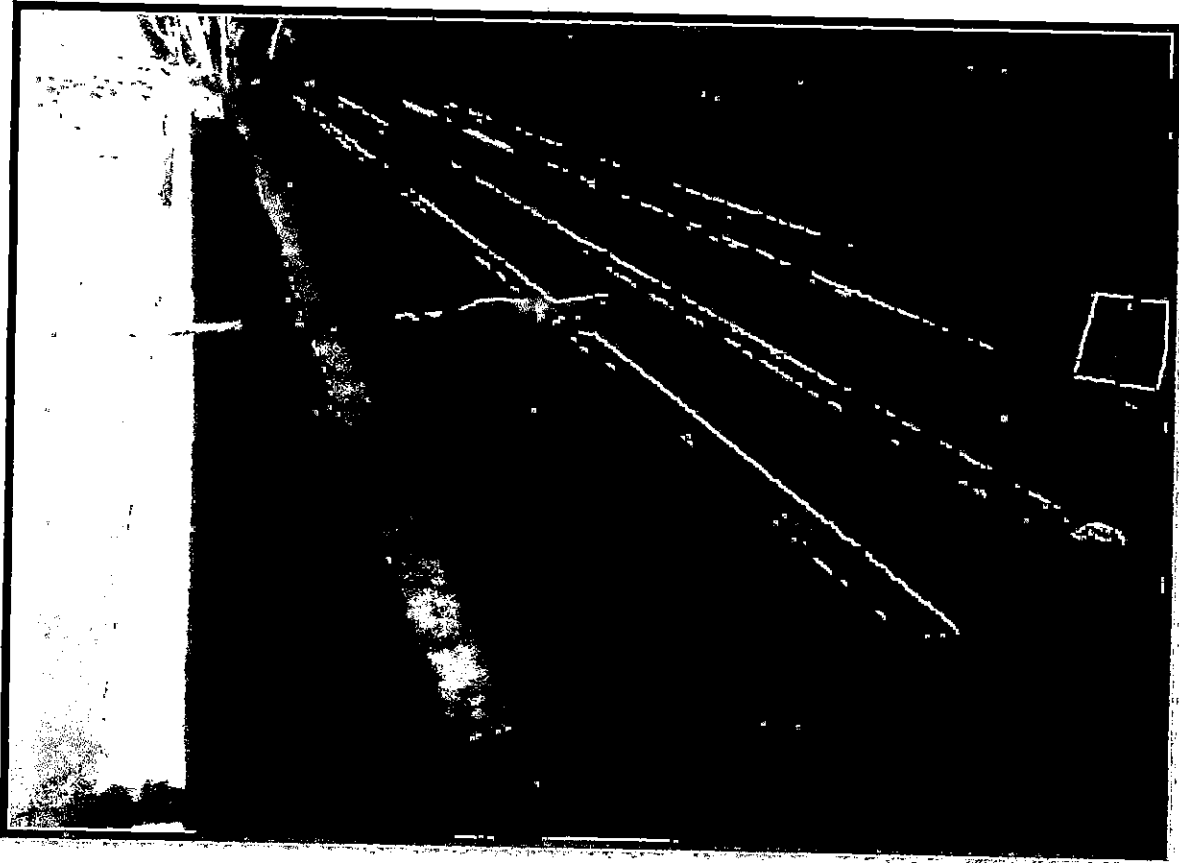

CONSORCIO MARITIMO DEL NORTE
DESEMBARCADERO ARTESANAL DE SÚPE

[Handwritten Signature]

DANIEL JOAQUIN MORALES VIVANCO
RESIDENTE DE OBRA
REG. CIP N° 98098

01 OBRAS PORTUARIAS

000315

01.02 MUELLE TIPO ESPIGÓN

01.02.01 FABRICACIÓN DE PILOTES DE CONCRETO

01.02.01.03 ACERO CORRUGADO FY=4200KG/CM2

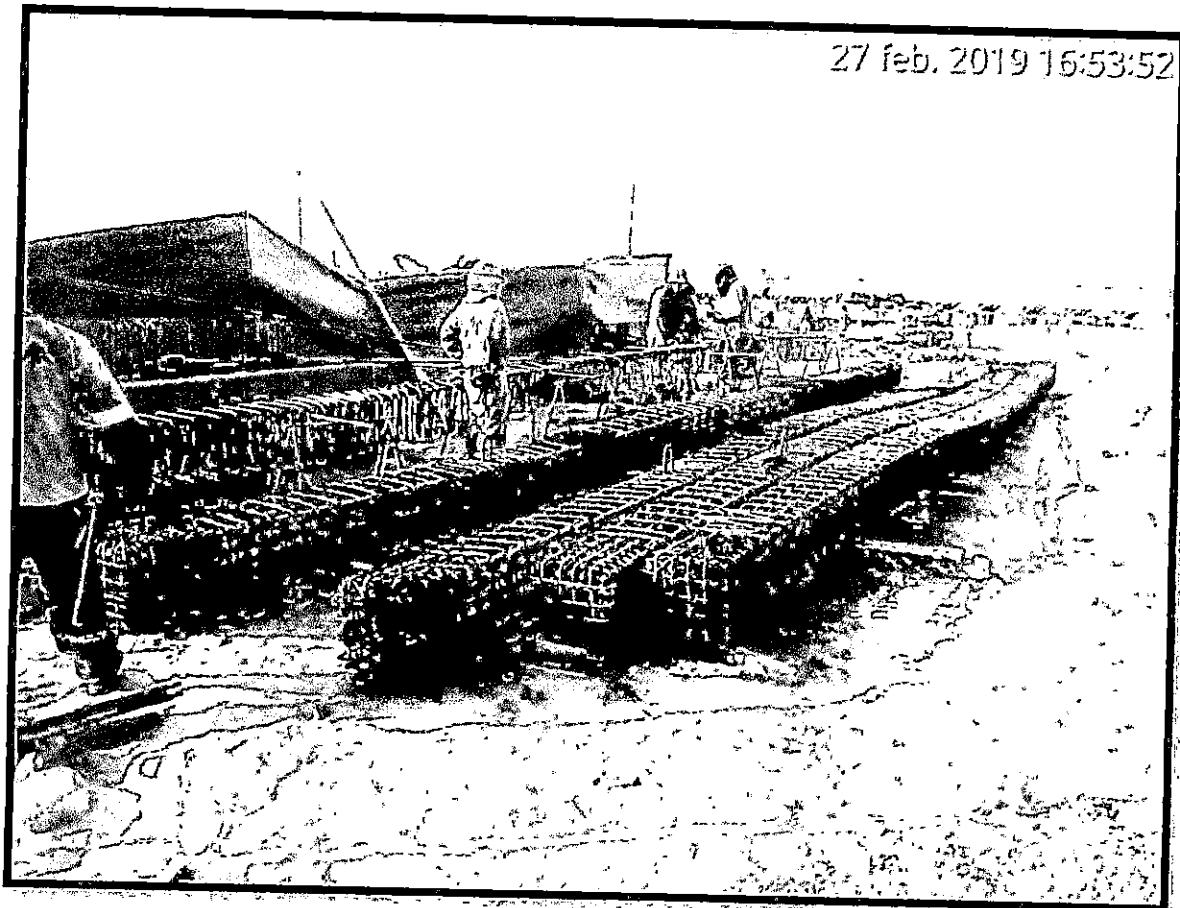

CONSORCIO MARÍTIMO DEL NORTE
DESEMPARCADERO ARTESANAL DE SUPE
[Signature]
DAMEL JOAQUIN MORALES VIVANCO
RESIDENTE DE OBRA
REG. CIP N° 98098

ANEXO N°02

000314

ESTRUCTURAS EN TIERRA

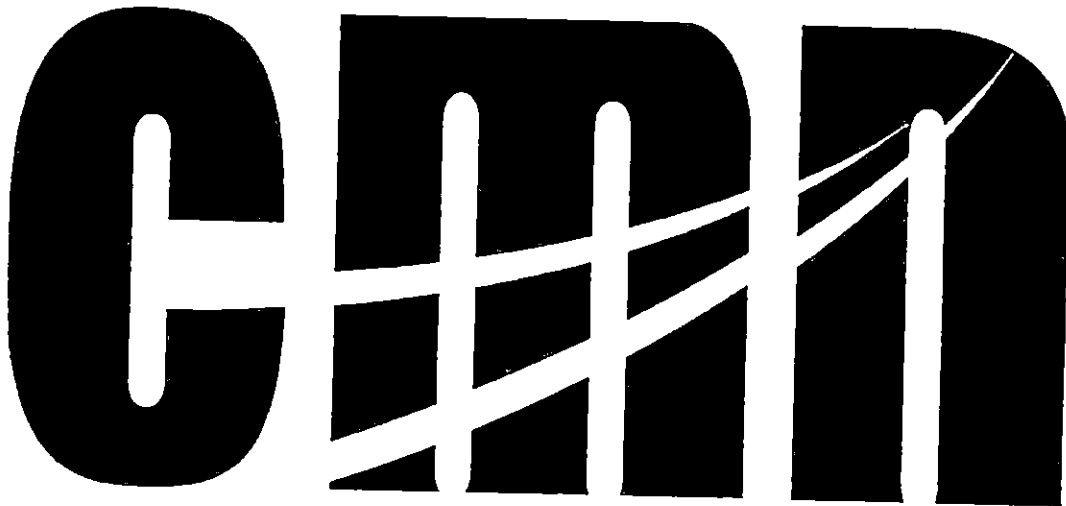

CONSORCIO MARITIMO DEL NORTE

"Mejoramiento y Recuperación de los servicios del Desembarcadero Pesquero Artesanal de Supe,
Distrito de Supe Puerto, Provincia de Barranca, Región Lima"

FEBRERO

2019

CONSORCIO MARITIMO DEL NORTE
DESEMBARCADERO ARTESANAL DE SUPE

DANIEL JOAQUIN MORALES VIVANCO
RESIDENTE DE OBRA
REG. CIP N° 98098

02 ESTRUCTURAS EN TIERRA

**ESTRUCTURAS
MURO LADRILLO**

FEBRERO

ASENTADO DE LADRILLO KK= 0.15m

UBICACIÓN/DESCRIPCION	BLOQUE	VECES	L	H	PARCIAL	TOTAL
Muro de cerco Eje: A / 4'-7'	2	1	3.73	2.65	9.88	
		1	3.4	2.65	9.01	
Muro de cerco - Eje: T	1	4	3.05	2.65	32.33	
		1	3.07	2.65	8.14	
		1	3.05	2.65	8.08	
		1	3.08	2.65	8.16	
Muro de cerco Eje: B - A	6	1	2.34	2.65	6.20	
		1	2.89	2.65	7.66	
		1	2.76	2.65	7.31	
		1	2.94	2.65	7.79	
Muro de cerco Eje: O - S	3	2	2.49	2.65	13.20	
		1	2.47	2.65	6.55	
Muro de cerco - Eje: A	4	1	3.11	2.65	8.24	
		1	3.07	2.65	8.14	
		1	3.14	2.65	8.32	
		1	0.76	2.65	2.01	
Muro de cerco Eje: G	10	1	10.6	2.55	27.03	

178.05

 CONSORCIO MARITIMO DEL NORTE
 DESEMBARCADERO ARTESANAL DE SUPE

 DANIEL JOAQUIN MORALES VIVANCO
 RESIDENTE DE OBRA
 REG. CIP N° 98098

000913

ESTRUCTURAS
COLUMNETAS

FEBRERO

CONCRETO M3									ENCOFRADO M2					ACERO														
UBICACIÓN/DESCRIPCIÓN	DIBUJO	COLUMNA	VECES	L	A	H	PARCIAL	TOTAL	VECES	L	H	PARCIAL	TOTAL	Φ	VECES	CANT.	LONG.	0.39	0.56	1.00	1/4"	3/8"	1/2"	5/8"	3/4"	1"	1 3/8"	
Muro de cerco Eja: A / 4-7	2	C1	3	0.3	0.15	3.35	0.45		1	0.65	3.35	2.178		1/2"	3	4	4.85						58.20					
Muro de cerco Eja: 1	1	C1	9	0.3	0.15	3.4	1.38		2	0.525	3.35	3.52		3/8"	3	32	0.85					45.70						
		C1A							5	0.65	3.4	11.85		1/2"	9	4	5.1											183.60
Muro de cerco Eja: F - B	7	C1	3.00	0.30	0.15	3.35	0.45		3	0.45	3.35	6.53		3/8"	9	27	0.8					108.86						
		C1A	2.00	0.30	0.15	3.35	0.30		2	0.775	3.35	5.19		1/2"	5	4	5.1											102.00
Muro de cerco Eja: B - A	6	C1	4	0.30	0.15	3.35	0.60		4	0.45	3.35	8.71		1/2"	6	4	5.1						60.48					122.40
		C2	1	0.25	0.25	3.35	0.21		1	0.75	3.35	2.51		3/8"	4	27	0.8						48.38					
		C3	1	0.25	0.25	3.35	0.21		1	0.75	3.35	2.51			2	27	0.85					25.70						
Muro de cerco Eja: H - L	5	C1a	1	0.30	0.15	3.35	0.15		1	0.75	3.35	2.51		1/2"	8	4	5.10											163.20
		C1b	3	0.30	0.15	3.35	0.45		3	0.42	3.35	4.22			2	6	5.10											61.20
		C1c	3	0.30	0.15	3.35	0.45		3	0.45	3.35	6.53		3/8"	7	27	0.80						84.67					
		C2	1	0.25	0.25	3.35	0.21		1	0.75	3.35	2.51			1	27	0.85					12.85						
		C3	1	0.12	<-Arna	3.35	0.40		1	1.25	3.35	4.19			2	27	1.40					42.34						
		C4	1	0.50	0.25	3.35	0.42		1	1.25	3.35	4.19		1/2"	4	4	5.1											81.60
Muro de cerco Eja: O - S	3	C1	4	0.30	0.15	3.35	0.60		4	0.65	3.35	8.71		3/8"	4	27	0.8						48.38					
Muro de cerco Eja: A	4	C1	3	0.30	0.15	3.35	0.45		3	0.65	3.35	6.53		1/2"	3	4	5.10											61.20
		C2	1	0.25	0.25	3.35	0.21		1	0.75	3.35	2.51			1	4	5.10						20.40					
		C1a	1	0.25	0.15	3.35	0.13		1	0.45	3.35	1.42			1	4	5.10						20.40					
														3/8"	3	27	0.80						34.29					
															1	27	0.85						12.85					
															1	27	0.66						9.98					
								7.08					92.00										536.49					874.20

CONSORCIO MARITIMO DEL NORTE
DESEMBARCADERO ARTESANAL DE SUPE

DANIEL JOAQUIN MORALES VIVANCO
RESIDENTE DE OBRA
REG. CIP N° 98098

000311

**ESTRUCTURAS
SOBRE CIMIENTO CORRIDO**

FEBRERO

CONCRETO M3							ENCOFRADO M2					ACERO													
UBICACIÓN/DESCRIPCIÓN	BLOQUE	L	A	H	PARCIAL	TOTAL	VECES	L	H	PARCIAL	TOTAL	φ	CANT.	LONG.	0.39	0.56	1.00	1/4"	3/8"	1/2"	5/8"	3/4"	1"	1 3/8"	
Muro de cerco Eje: G	10	10.6	0.125	0.85	1.13		2	10.6	0.85	18.02		3/8"	42	2					47.04						
Caseta de Seguridad 2 - Eje: G - F	9	6.77	0.125	1.25	1.06		2	6.77	1.25	16.93		3/8"	8	12.37					55.42						
													3/8"	27	1.95					29.48					
						2.18					34.95									38.98					
																				170.92					

CONSORCIO MARITIMO DEL NORTE
DESEMBARCADERO ARTESANAL DE SUPE

DANIEL JOAQUIN MORALES VIVIACO
RESIDENTE DE OBRA
REG. CIP N° 98098

000310



COFRADO M2

H	PARCIAL	TOTAL
1.00	25.06	
0.50	2.45	
		27.51

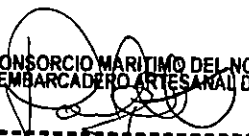
CONSORCIO MARITIMO DEL NORTE
DESEMBARCADERO ARTESANAL DE SUPE



DANIEL JOAQUIN MORALES VIVANCOS
RESIDENTE DE OBRA
REG. CIP N° 98098

000309

**ESTRUCTURAS
CIMIENTO CORRIDO**

FEBRERO

CONCRETO M3							EN	
UBICACIÓN/DESCRIPCION	BLOQUE	L	A	H	PARCIAL	TOTAL	VECES	L
Muro de cerco Eje: G	10	12.53	0.9	1	11.28		2.00	12.53
Caseta de Seguridad 2 - Eje: G - F	9	4.9	0.6	0.5	1.47		1.00	4.90
						12.75		

 CONSORCIO MARITIMO DEL NORTE
 DESEMBARCADERO ARTESANAL DE SUPE

 DANIEL JOAQUIN MORALES VIVAS
 RESIDENTE DE OBRA
 REG. CIP N° 98098

000308

**PLANILLA DE METRADOS
MOVIMIENTO DE TIERRA
EXCAVACION M3**

FEBRERO

UBICACIÓN/DESCRIPCION	BLOQUE	UND	L	A	H	PARCIAL	TOTAL
Muro de cerco Eje: G	10	M3	11.9	0.9	2.3	24.63	
Caseta de Seguridad 2 - Eje: G - F	9	M3	2.55	2.22	2.1	11.89	
Muro de cerco - PTAR	11	M3	35	0.9	2.1	66.15	
Cisterna Frio	12	M3	7.47	3.3	2.82	69.52	
							172.19

 CONSORCIO MARTINO DEL NORTE
 DESEMBARCADERO ARTESANAL DE SUPE

 DANIEL JOAQUIN MORALES VIVANCO
 RESIDENTE DE OBRA
 REG. CIP N° 98098

000304

**PLANILLA DE METRADOS
ESTRUCTURAS:
ZAPATAS**

UBICACIÓN	DESCRIPCIÓN DEL ELEMENTO	CANTIDAD	CONCRETO			ENCOPRADO Y DESENCOPRADO		ACERO			LONGITUD ACERO								
			DIMENSIÓN (M)			TOTAL (M3)	MEDIDAS		TOTAL (M2)	Ø	CANT.	LONG.	1/4"	3/8"	1/2"	5/8"	3/4"	1"	1 3/8"
			L	A	H		P	H											
Feb-19	CASETA DE VIGILANCIA VEHICULAR	4	1	1	0.5	2.00	4	0.5	8.00	1/2"	5	0.9						18	
										1/2"	5	0.9						18	
SUBTOTAL						2.00			8.00	LONGITUD TOTAL			36.00						
TOTAL						2.00			8	PESO DE VARILLAS			0.25 0.56 0.99 1.55 2.235 3.973 7.907						
										ACERO EN KG.			33.78 0.00						

CONSORCIO MARITIMO DEL NORTE
DESEMBARCADERO ARTESANAL DE SUPE

DANIEL JOAQUIN MORALES VIVA YCO
RESIDENTE DE OBRA
REG. CIP N° 98098

000306

02.03 MOVIMIENTO DE TIERRAS

000305

02.03.01 CORTE MASIVO

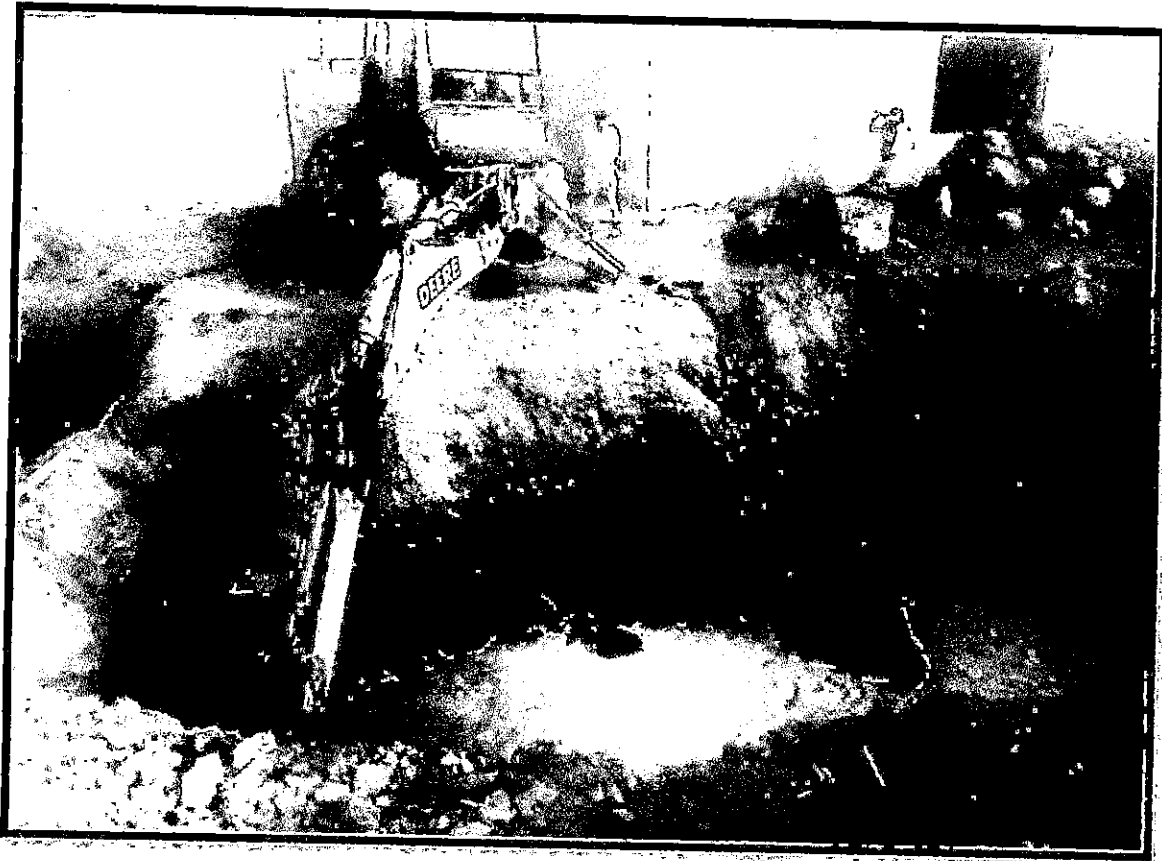

CONSORCIO MARITIMO DEL NORTE
DESEMBARCADERO ARTESANAL DE SÚPE
DANIEL JOAQUIN MORALES VIVANCO
RESIDENTE DE OBRA
REG. CIP N° 98098

02 ESTRUCTURAS EN TIERRA

02.04 CONCRETO SIMPLE

000304

02.04.02 CIMIENTO

02.04.02.02 ENCOFRADO Y DESENCOFRADO CIMIENTO CERCO

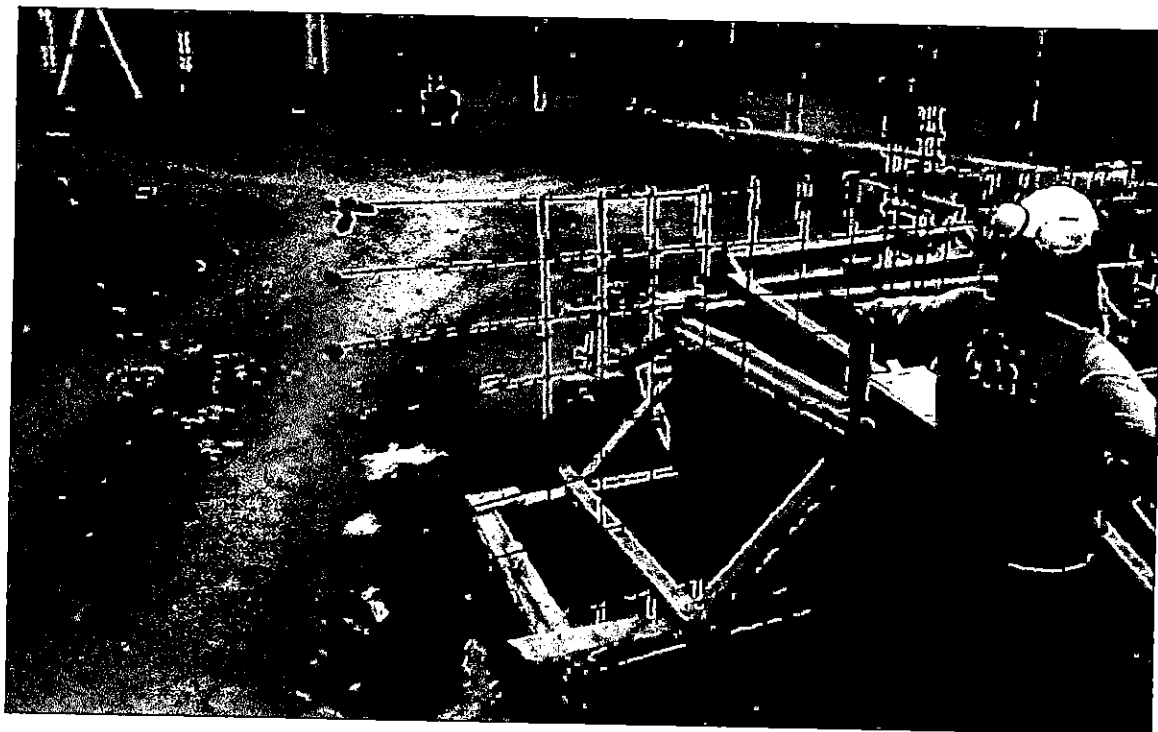

CONSORCIO MARITIMO DEL NORTE
DESARROLLO ARTESANAL DE SUPE

DANIEL JOAQUIN MORALES VIVA VCO
RESIDENTE DE OBRA
REG. CIP N° 98098

02 ESTRUCTURAS EN TIERRA

000303

02.05 CONCRETO ARMADO

02.05.03 SOBRECIMIENTO REFORZADO

02.05.03.02 ENCOFRADO Y DESENCOFRADO DE SOBRECIMIENTO REFORZADO

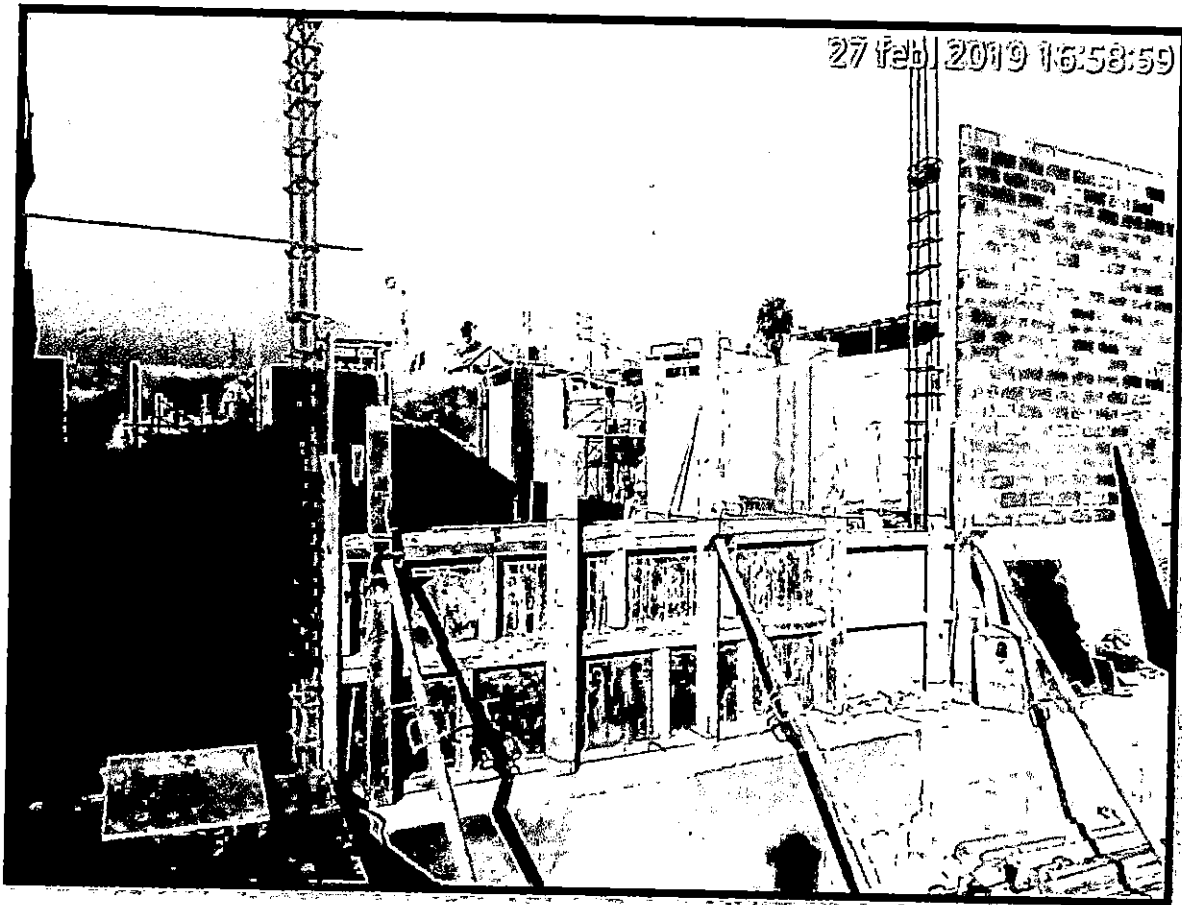

CONSORCIO MARITIMO DEL NORTE
DESEMBARCADERO ARTESANAL DE SUPE

DANIEL JOAQUIN MORALES VIVA NCO
RESIDENTE DE OBRA
REG. CIP N° 94098

02 ESTRUCTURAS EN TIERRA

02.05 CONCRETO ARMADO

000302

02.05.06 VIGAS

02.05.06.01 CONCRETO F'C=210 kg/cm2 EN VIGAS

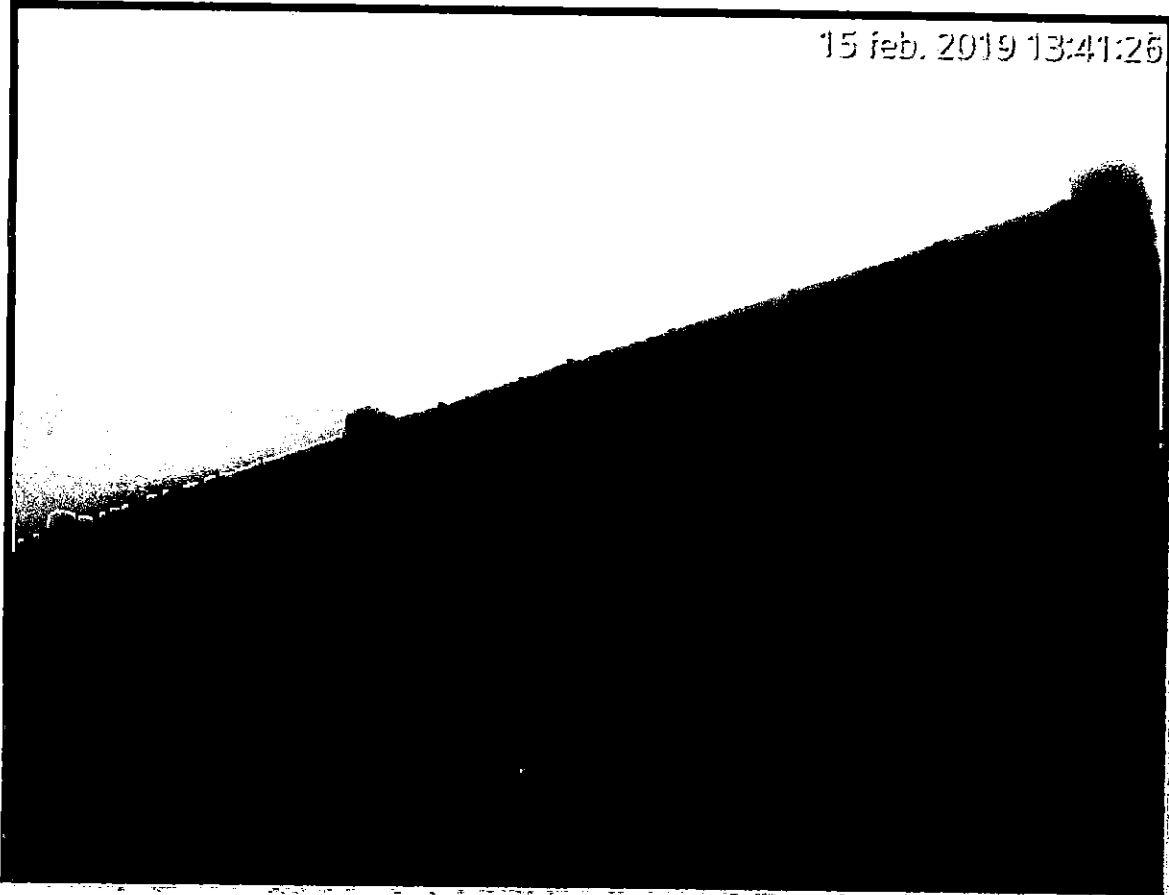

CONSORCIO MARITIMO DEL NORTE
DESEMARCADERO ARTESANAL DE SUPE

[Handwritten Signature]
DAMEL JOAQUIN MORALES VIVANCO
RESIDENTE DE OBRA
REG. CIP N° 98098

000301

ANEXO N°03

ARQUITECTURA

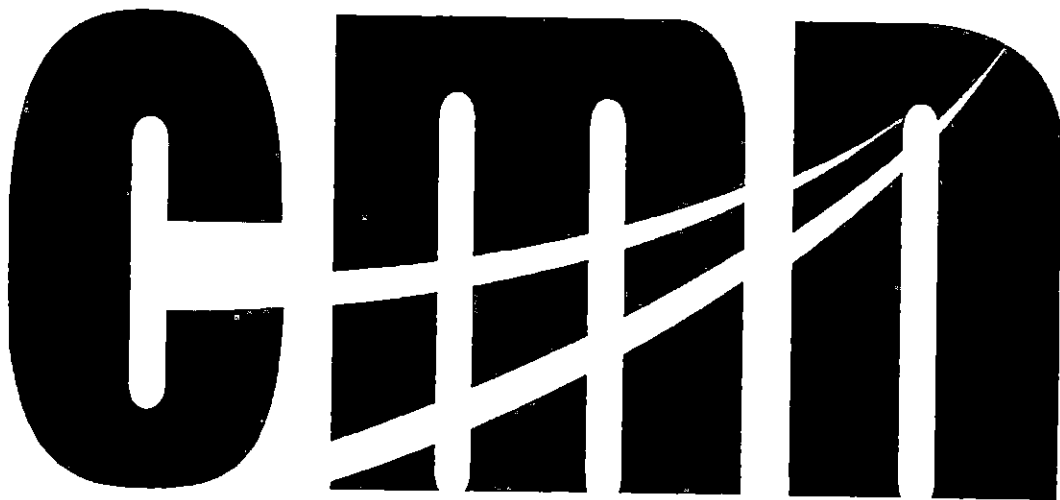

XONΣOPXIO MAPITIMO ΔEA NOΠTE

"Mejoramiento y Recuperación de los servicios del Desembarcadero Pesquero Artesanal de Supe,
Distrito de Supe Puerto, Provincia de Barranca, Región Lima"

FEBRERO

2019

CONSORCIO MARITIMO DEL NORTE
DESEMBARCADERO ARTESANAL DE SUPE
DANIEL JOAQUIN MORALES VIVANCO
RESIDENTE DE OBRA
REG. CIP N° 98098

03 ARQUITECTURA

ARQUITECTURA
TARRAJEO M2
FEBRERO

TARRAJEO DE MUROS								TARRAJEO DE COLUMNAS / PLACAS							TARRAJEO DE VIGAS				
UBICACIÓN/DESCRIPCIÓN	BLOQUE	VECES	L	H	PARCIAL	TOTAL		VECES	AREA	L	H	PARCIAL	TOTAL	VECES	L	H	PARCIAL	TOTAL	
									Eje: L-M				3.87					3.87	
									Eje: M-N				3.87					3.87	
									Eje: N-O				3.87					3.87	
									Eje: O-P				3.87					3.87	
								Eje: 7	Eje: H				3.93					3.93	
								Exterior	Eje: I				6.30					6.30	
									Eje: J				6.30					6.30	
									Eje: K				6.30					6.30	
									Eje: L				6.30					6.30	
									Eje: M				6.30					6.30	
									Eje: N				6.30					6.30	
									Eje: O				6.30					6.30	
									Eje: P				3.93					3.93	
								Eje: 7	Eje: H-I				6.47					6.47	
								Exterior	Eje: I-J				6.47					6.47	
									Eje: J-K				6.47					6.47	
									Eje: K-L				6.47					6.47	
									Eje: L-M				6.47					6.47	
									Eje: M-N				6.47					6.47	
									Eje: N-O				6.47					6.47	
									Eje: O-P				6.47					6.47	
													268.29						

CONSORCIO MARITIMO DEL NORTE
DESEMBARCADEÑO ARTESANAL DE SUPE

DANIEL JOAQUIN MORALES VIVI TICL
RESIDENTE DE OBRA
REG. CIP N° 98098

000299

ARQUITECTURA

DERRAMES

FEBRERO

TARRAJEO DE MUROS

UBICACIÓN/DESCRIPCION	BLOQUE		CANTIDAD	VECES	L	PARCIAL	TOTAL
Muro de cerco - Eje: T	1	e= 0.15		1	21.04	21.04	
Muro de cerco - Eje: A	2	e= 0.15		1	7.58	7.58	
Muro de cerco Eje: H - L	5	e= 0.15		1	21.08	21.08	
Muro de cerco Eje: O - S	3	e= 0.15		1	8.05	8.05	
Muro de cerco - Eje: F - B	7	e= 0.15		1	12.17	12.17	
Muro de cerco Eje: B - A	6	e= 0.15		1	15.02	15.02	
Tareas Previas Eje: 7 y 2	Ventana alta	e= 0.25	2	8	8.00	128.00	
	Ventana Enro.	e= 0.15	2	8	5.20	83.20	
	Puerta Secc.	e= 0.15	2	8	8.55	136.80	
							432.94

 CONSORCIO MARITIMO DEL NORTE
 DESEMBARCADERO ARTESANAL DE SUPE

 DANIEL JOAQUÍN MORALES VIVAS
 RESIDENTE DE OBRA
 REG. CIP N° 98098

000098

**ARQUITECTURA
IMPRIMANTE 1º MANO**

FEBRERO

DESCRIPCION	Und	Veces	Cantidad	Area	Long.	Ancho	Altura	Parcial	Total
DESINFECCION									
Imprimante 1º Mano - CIELO RASO	m2								234.49
Pasillo		1	1	42.90				42.90	
Lavanderia - Entrega de Uniforme		1	1	35.66				35.66	
Vestuario de hombre		1	1	17.00				17.00	
SS.HH Hombres		1	1	20.97				20.97	
SS.HH Mujeres		1	1	20.20				20.20	
Vestuario de Mujeres		1	1	17.00				17.00	
Grupo Electrogeno		1	1	19.39				19.39	
SubEstacion Electrica		1	1	20.01				20.01	
Maestranza		1	1	41.36				41.36	
Cuarto de Tableros									
Deposito de Limpieza									
Imprimante 1º Mano - Muro Exterior	m2								144.64
Eje: S (corte C-C)		1	1	18.58				18.58	
Eje: T / 2 - 17"		1	1	20.43	38.55		3.80	126.06	
ZONA DE AREAS SOCIALES									
Imprimante 1º Mano - CIELO RASO	m2								38.00
Taller de redes		1	1	38.00				38.00	
Imprimante 1º Mano - Muro Exterior	m2								65.30
Eje: 4' (corte 1-1)		1	1	18.93				18.93	
Eje: D/ 1 - 4		1	1	14.67				14.67	
Eje: 1'/A -D		1	1	31.70				31.70	
ZONA DE FRIO									
Imprimante 1º Mano - CIELO RASO	m2								249.30
Cuarto de Maquinas									
Oficinas de Mantenimiento		1	1	216.11				216.11	
Pasillo									
Cuarto de hielo									
Guardiana		1	1	33.19				33.19	
Imprimante 1º Mano - Muro Interior	m2								113.56

 CONSORCIO MARITIMO DEL NORTE
 DESEMBARCADERO ARTESANAL DE SUPE
 DANIEL JOAQUIN MORALES VIZA YCA
 RESIDENTE DE OBRA
 REG. CIP N° 98098

000097

**ARQUITECTURA
IMPRIMANTE 1º MANO**

FEBRERO

DESCRIPCION	Und	Veces	Cantidad	Area	Long.	Ancho	Altura	Parcial	Total
Eje: G									
		1	6	13.94				83.64	
Eje: F									
		1	1		14.38		1.20	17.26	
		1	1		2.58		3.50	9.03	
		1	1		3.30		1.10	3.63	
									845.29

 CONSORCIO MARITIMO DEL NORTE
 DESEMBARCADERO ARTESANAL DE SUPE

DANIEL JOAQUÍN MORALES VIVANCO
 RESIDENTE DE OBRA
 REG. CIP N° 98098

000296

03.01 ALBAÑILERIA

000295

03.01.01 MURO DE LADRILLO KING KONG E=0.15m.

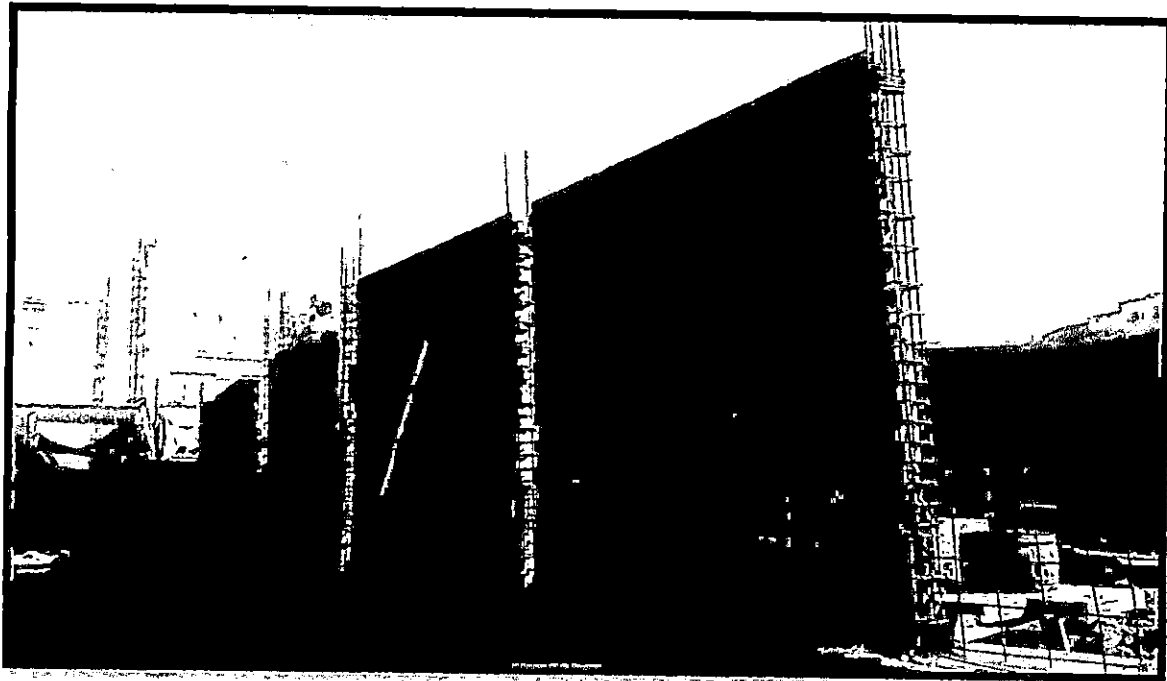

CONSORCIO MARTINO DEL NORTE
DESEMBARCADERO ARTESANAL DE SUPE
[Signature]
DANIEL JOAQUIN MORALES VIVACO
RESIDENTE DE OBRA
REG. CIP N° 98098

03 ARQUITECTURA

000294

03.02 REVOQUES ENLUCIDOS Y MOLDURAS

03.02.01 TARRAJEO EN INTERIORES ACABADO CON CEMENTO-ARENA

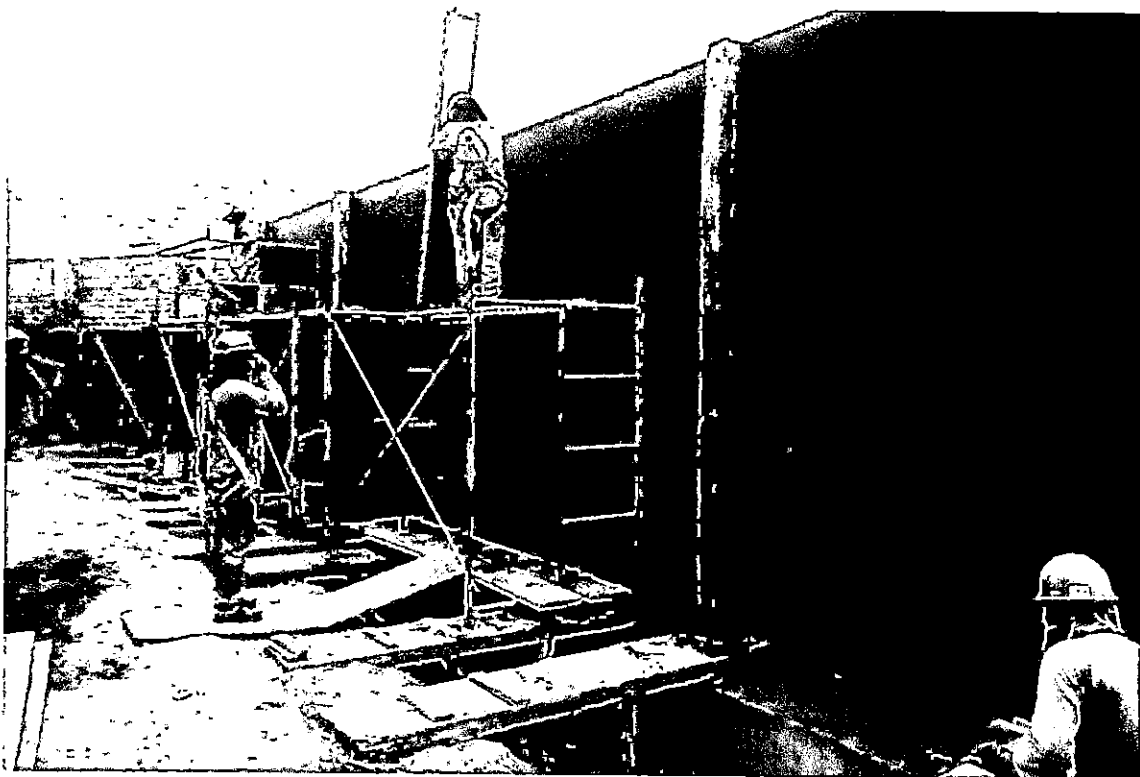

CONSORCIO MARITIMO DEL NORTE
DESEMBARCADERO ARTESANAL DE SUPE

[Handwritten Signature]
DAMEN JOAQUIN MORALES VIVANCO
RESIDENTE DE OBRA
REG. CIP N° 98098

000203

03 ARQUITECTURA

03.02 REVOQUES ENLUCIDOS Y MOLDURAS

03.02.02 TARRAJEO EN EXTERIORES ACABADO CON CEMENTO-ARENA

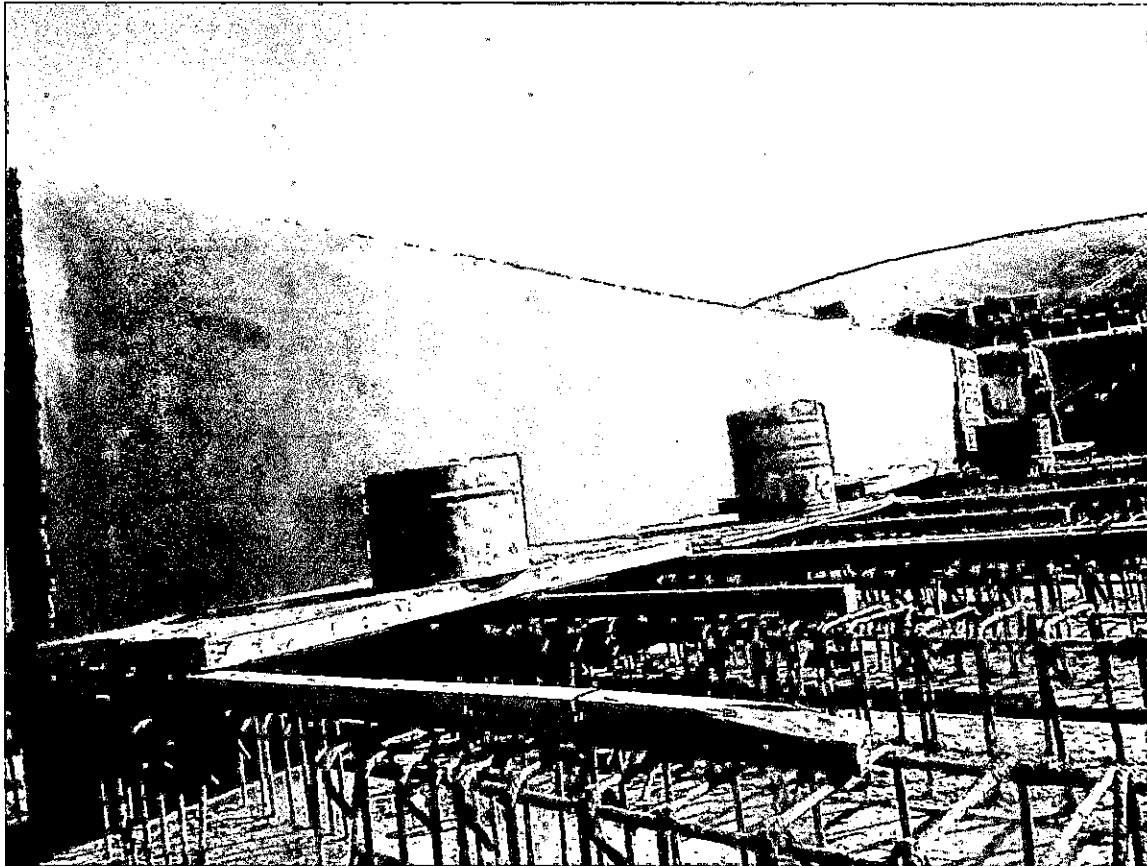

CONSORCIO MARITIMO DEL NORTE
DESEMBARCADERO/ARTESANAL DE SUPE

[Handwritten Signature]
DANIEL JOAQUIN MORALES VIVANCO
RESIDENTE DE OBRA
REG. CIP N° 98098

000292

03 ARQUITECTURA

03.11 PINTURA

03.11.02 PINTURA EN MUROS Y COLUMNAS INTERIORES CON LATEX

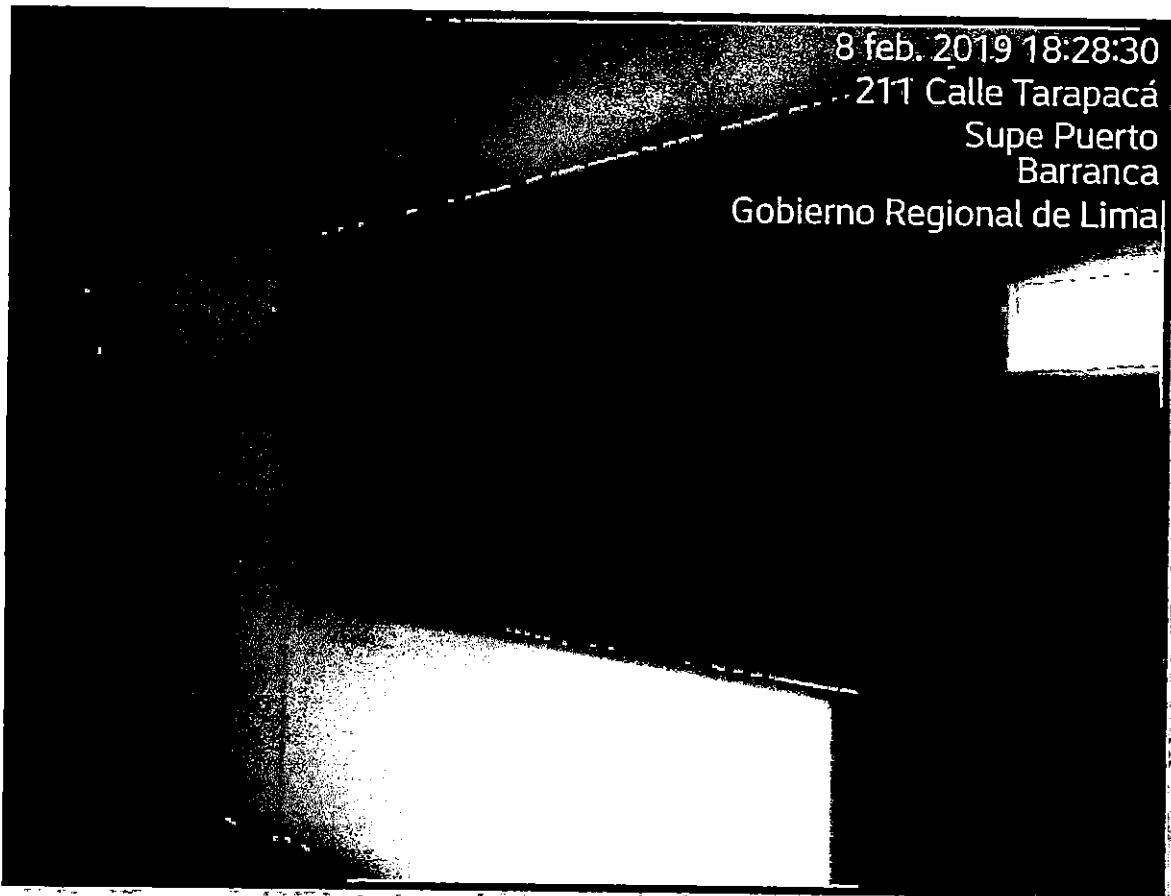

CONSORCIO MARITIMO DEL NORTE
DESEMBARCADERO ARTESANAL DE SUPE
DANIEL JOAQUIN MORALES VIVANCO
RESIDENTE DE OBRA
REG. CIP N° 98098

000291

03 ARQUITECTURA

03.11 PINTURA

03.11.02 PINTURA EN MUROS Y COLUMNAS Y VIGAS EXTERIORES CON LATEX



CONSORCIO MARITIMO DEL NORTE
DESEMBARCADERO ARTESANAL DE SUPE
DANIEL JOAQUIN MORALES VIVANCO
RESIDENTE DE OBRA
REG. CIP N° 98098

000290

ANEXO N°05

INSTALACIONES SANITARIAS

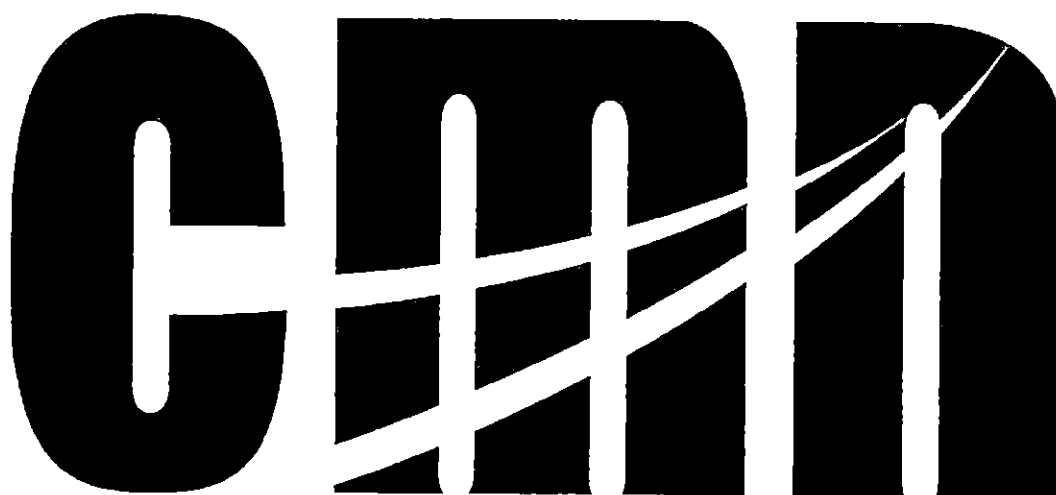

ΧΟΝΣΟΡΧΙΟ ΜΑΡΙΤΙΜΟ ΔΕΑ ΝΟΡΤΕ

"Mejoramiento y Recuperación de los servicios del Desembarcadero Pesquero Artesanal de Supe,
Distrito de Supe Puerto, Provincia de Barranca, Región Lima"

FEBRERO

2019

CONSORCIO MARITIMO DEL NORTE
DESEMBARCADERO ARTESANAL DE SUPE



DANIEL JOAQUIN MORALES VIVA
RESIDENTE DE OBRA
REG. CIP N° 98096

INSPECCION DE ENCOFRADO

Contratista:	CONSORCIO MARITIMO DEL NORTE		Fecha:	18-01-19
Cliente:	FONDO NACIONAL DE DESARROLLO PESQUERO - FONDEPES		Documentos de referencia:	
Ubicación:				
Tipo de estructura:	Caja de Registro			

ESQUEMA DEL ENCOFRADO:

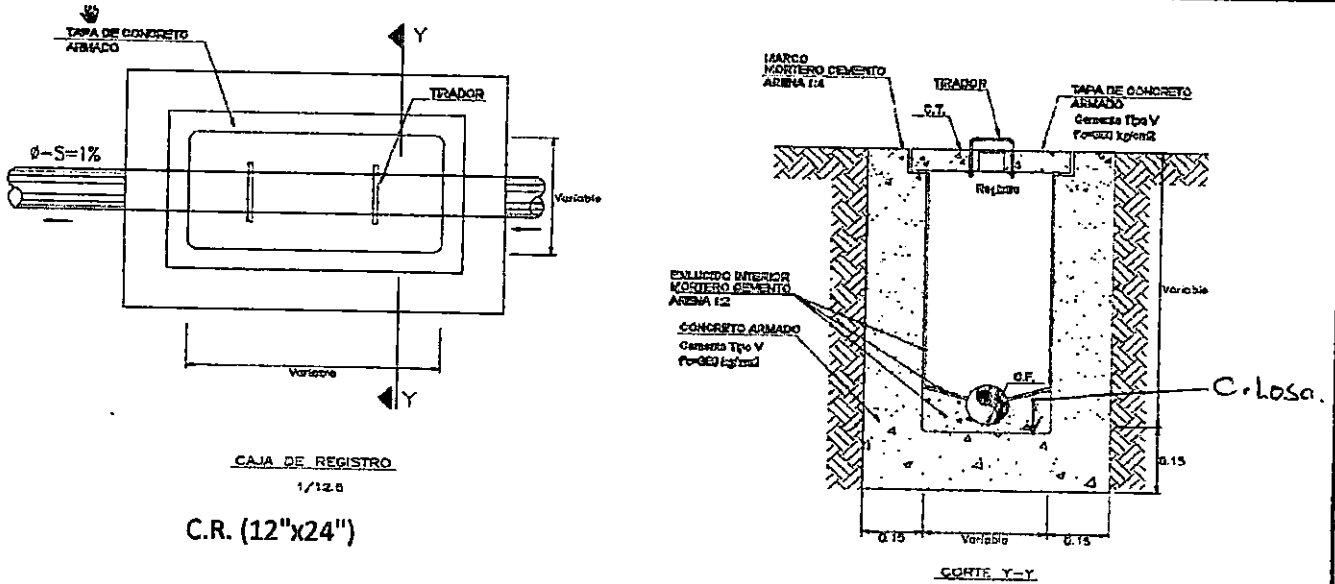
Graficar el elemento, identificar ubicación por ejes, puntualizar detalles del encofrado



DATOS DIMENSIONALES (mm):

PUNTOS PLOMADA																			
ARRIBA																			
ABAJO																			
DESVIACION																			

CHECKLIST DEL ENCOFRADO:

	CONFORME	NO CONFORME	NO APLICA	REPARADO/CO RREGIDO	COMENTARIOS
Material del encofrado	/				
Condición del encofrado	/				
Empieza de formas del encofrado	/				
Forma y dimensiones del encofrado	/				
Aplicación de desmoldante	/				
Aseguramiento de soleras	/				
Apuntalamiento y fijación	/				
Hermeticidad del encofrado	/				
Fecha de desencofrado	/				

COMENTARIOS / OBSERVACIONES GENERALES:

Encofrado de 3 capas de concreto de desague, según ubicación indicada en C.M.S. A.V.S. - C.

Responsable de Campo:	Seño y Firma: Ing. Luis M. Vera Castañeda INGENIERO CIVIL REG. CIP 140278	Control de Calidad:	Seño y Firma: 18.01.19 BRYAN GALINDO VEGA CONTROL DE CALIDAD CONSORCIO MARITIMO DEL NORTE
Residente de Obra:	Seño y Firma: CONSORCIO MARITIMO DEL NORTE DESEMBARCADERO ARTESANAL DE SUPE DANIEL JOAQUÍN VERA RESIDENTE DE OBRA REG. CIP N° 140278	Supervisor de Obra:	Seño y Firma: ING. PEDRO MUCKA CESEL S.A. SUPERVISOR DE OBRA 18.01.19

()

05-01-05-01

5-DIC-18-07 OKSD



CONTROL DE CALIDAD

PROTOCOLOS CHECK LIST - II.SS.

CC275-IA-CMN

REGISTRO:

PROYECTO: MEJORAMIENTO Y RECUPERACIÓN DE LOS SERVICIOS DEL DESEMBARCADERO PESQUERO ARTESANAL DE SUPE

CLIENTE: FONDO NACIONAL DE DESARROLLO PESQUERO - FONDEPES

SISTEMA: II. SS.

SECTOR: ADMINISTRACION DE MANIOBRAS

CONTRATISTA: CONSORCIO MARÍTIMO DEL NORTE

FECHA:

PLANO DE REFERENCIA: 1SC-02

CHECKLIST DE VERIFICACION

SALIDAS DE DESAGUE

1ER REV.

2DA REV.

OBSERVACIONES

ACABADO DE NICHOS PARA VALVULAS ESFERICAS

/

3 VALVULAS 1/2"

/

P

2.- COMENTARIOS

solo el acabado de 3 nichos - Falta tapas. JB

000388

CONTROL DE CALIDAD:

RESIDENTE

JEFE DE OBRAS CIVILES:

SUPERVISIÓN:

Firma y sello:

Firma y sello:

Firma y sello:

NOMBRE:

Signature of Brayan Galindo Vega

BRAYAN GALINDO VEGA
CONTROL DE CALIDAD
CONSORCIO MARITIMO DEL NORTE

05.12.18

CONSORCIO MARITIMO DEL NORTE
DESEMBARCADERO ARTESANAL DE SUPE

DANIEL JOAQUIN MORALES V. G.
RESIDENTE DE OBRA
REG. CIP N° 96098

05.12.18

NOMBRE:

Signature of Ing. Luis Al. Vera Castañeda

Ing. Luis Al. Vera Castañeda
INGENIERO CIVIL
REG. CIP 140228

NOMBRE:



Signature of Pedro Mucumayaz

05.12.18

05-01-05-01

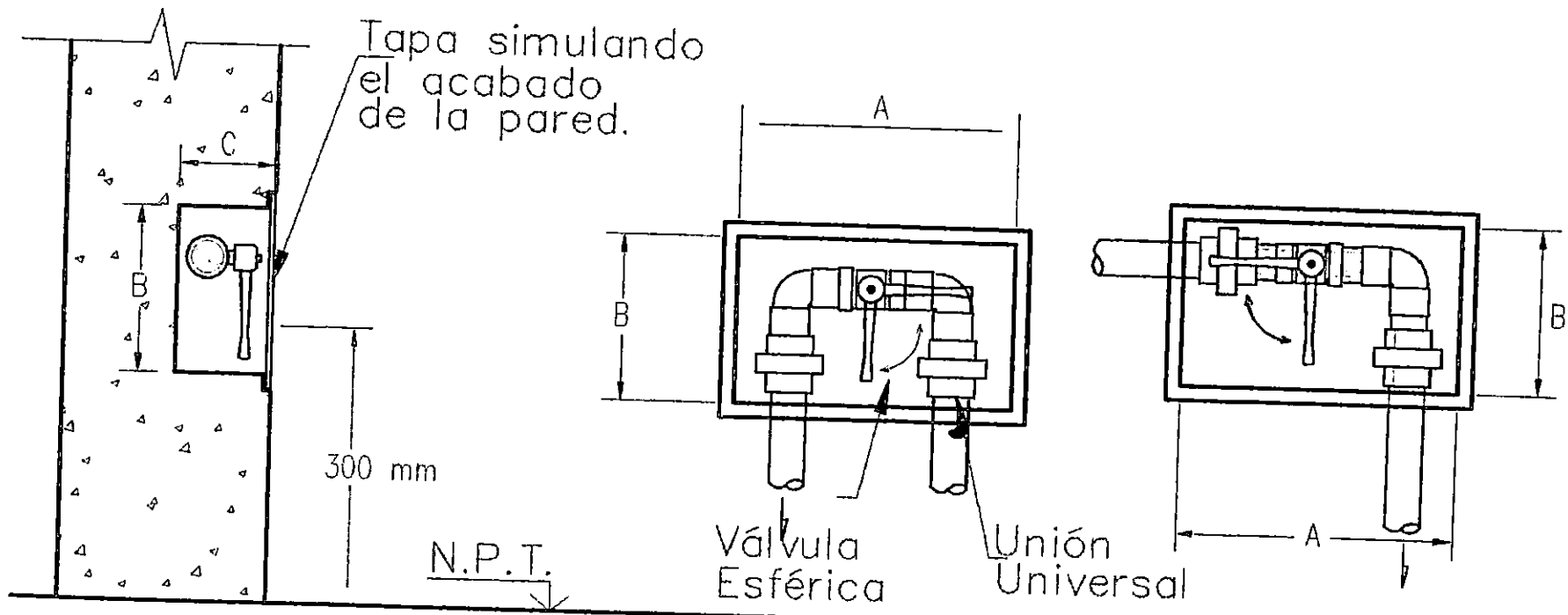

Cuadro de Dimensiones

DIAMETRO	A (mm)	B (mm)	C (mm)
∅ 1/2" ✓	200 ✓	150 ✓	100 ✓
∅ 3/4"	200	150	100
∅ 1"	300	200	120
∅ 1 1/4"	300	200	120
∅ 1 1/2"	300	250	120

GL
 CRAYAN BALINDO VEGA
 CONTROL DE CALIDAD
 CONSORCIO MARITIMO DEL NORTE

ING. PEDRO MUCHA PAZ
 CESEL S.A.
 SUPERVISOR DE OBRAS

CONSORCIO MARITIMO DEL NORTE
 DESEMBARCADERO ARTESANAL DE TURKEY
 DANIEL JOAQUIN DE ROSA
 RESIDENTE EN TURKEY
 REG. CIP N. 11000

[Signature]
 Ing. Luis M. Vera Castañeda
 INGENIERO CIVIL
 REG. CIP N. 11000

000287



CONSORCIO MARÍTIMO DEL NORTE

MEJORAMIENTO Y RECUPERACION DE LOS SERVICIOS DEL
DESEMBARCADERO PESQUERO ARTESANAL DE SUPE, DISTRITO DE SUPE
PUERTO, PROVINCIA DE BARRANCA, REGIÓN LIMA

Tipo de Documento	N°	Mes	Fecha
Valorización	18	Febrero	28/02/2019

000286

RESOLUCION DEL ADICIONAL 06

CONSORCIO MARITIMO DEL NORTE
DESEMBARCADERO ARTESANAL DE SUPE

DANIEL JOAQUIN MORALES VIZA YCO
RESIDENTE DE OBRA
REG. CIP N° 98098



Lima, 28 DIC. 2018

CARTA N° 465 -2018-FONDEPES/GG

Señores
CONSORCIO MARÍTIMO DEL NORTE
Jr. Vizcaya N° 187, Urbanización Javier Prado
SAN LUIS.-

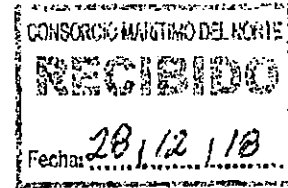

Asunto : Aprobar el Expediente Técnico de la prestación adicional de obra n.° 06 – Contrato n.° 025-2017-FONDEPES - *Contratación de la ejecución de la obra: «Mejoramiento y Recuperación de los Servicios del DPA de Supe, Distrito de Supe Puerto, provincia de Barranca, Región Lima».*

Referencia : Resolución Jefatural N° 158-2018-FONDEPES/J.

De mi consideración:

Tengo a bien dirigirme a ustedes, para saludarlos cordialmente y hacer de su conocimiento que el Fondo Nacional de Desarrollo Pesquero – FONDEPES, ha emitido la Resolución de la referencia, la misma que se adjunta para conocimiento y fines.

Atentamente,

FONDO NACIONAL DE DESARROLLO PESQUERO
FONDEPES
Karla Elizabeth Espinoza Malatesta
KARLA ELIZABETH ESPINOZA MALATESTA
GERENCIA GENERAL

Se adjunta: Resolución Jefatural n.° 158-2018-FONDEPES/J.
Memorando n.° 4829-2018-FONDEPES/DIGENIPAA.
Informe n.° 289-2018-FONDEPES-DIGENIPAA/AOEM/LATH.
Informe n.° 883-2018-FONDEPES/OGAJ.
Expediente Técnico en digital y físico de 379 folios.

c.c.: J /OGAJ / DIGENIPAA / OGA

KEEM/bpl



000284

RESOLUCIÓN JEFATURAL
N° 158-2018-FONDEPES/J

Lima, 28 DIC. 2018



M. QUERO

VISTOS: El Memorando n.º 4829-2018-FONDEPES/DIGENIPAA y el Informe n.º 289-2018-FONDEPES-DIGENIPAA/AOEM/LATH, ambos de la Dirección General de Inversión Pesquera Artesanal y Acuícola (DIGENIPAA), así como el Informe n.º 883-2018-FONDEPES/OGAJ de la Oficina General de Asesoría Jurídica (OGAJ); y,

CONSIDERANDO:

Que, el 22 de agosto de 2017, el Fondo Nacional de Desarrollo Pesquero (en adelante, el Fondepes) y el Consorcio Marítimo del Norte, integrado por las empresas Cefolsa Ingeniería y Construcción S.A.C, PCD S.A.C y Asphalt Tecnologías S.A.C., suscribieron el Contrato n.º 026-2017-FONDEPES para la contratación de la ejecución de obra: «Mejoramiento y Recuperación de los servicios del Desembarcadero Pesquero Artesanal de Supe, distrito de Supe Puerto, provincia de Barranca, región Lima» por el monto de S/ 21 509 091.48 (veintiún millones quinientos nueve mil noventa y uno con 48/100 Soles) incluido IGV, con un plazo de ejecución de 270 días calendario.

Que, el 15 de setiembre de 2017, el Fondepes y la empresa CESEL S.A. suscribieron el Contrato n.º 030-2017-FONDEPES para la contratación del servicio de consultoría de obra por paquete para la supervisión de la obra: «Mejoramiento y recuperación de los servicios del desembarcadero pesquero artesanal de Supe, distrito de Supe Puerto, provincia de Barranca, región Lima».

Que, el acto administrativo puede fundamentarse en informes de emisión previa que obren en el expediente correspondiente, a condición de su puntual identificación y su integración en el acto administrativo que motivan. Sobre el particular, el numeral 6.2 del artículo 6º del Decreto Supremo que n.º 006-2017-JUS que aprueba el Texto Único Ordenado de la Ley n.º 27444, Ley de Procedimiento Administrativo General establece lo siguiente:

«Artículo 6.- Motivación del acto administrativo

(...) 6.2 Puede motivarse mediante la declaración de conformidad con los fundamentos y conclusiones de anteriores dictámenes, decisiones o informes obrantes en el expediente, a condición de que se les identifique de modo certero, y que por esta situación constituyan parte integrante del respectivo acto. Los informes, dictámenes o similares que sirvan de fundamento a la decisión, deben ser notificados al administrado conjuntamente con el acto administrativo. (...).»

Conforme a la normativa indicada sobre el contenido motivacional constituyen fundamentos de la presente Resolución: el Memorando n.º 4829-2018-



K. ESPINOZA



LABQ



N SUPANTA

FONDEPES/DIGENIPAA, el Informe n.º 289-2018-FONDEPES-DIGENIPAA/AOEM/LATH y el Informe n.º 883-2018-FONDEPES/OGAJ, los mismos que formarán parte integrante de la presente Resolución en calidad de anexos.

000283

Por los fundamentos técnicos y normativos expuestos, de conformidad con la Ley n.º 30225, Ley de Contrataciones del Estado, modificada por Decreto Legislativo n.º 1341, en adelante la Ley y, el Decreto Supremo n.º 350-2015-EF que aprueba el Reglamento de la Ley, modificado por Decreto Supremo n.º 056-2017-EF, en adelante el Reglamento; y, en ejercicio de las funciones establecidas por el literal "s" del artículo 8 del Reglamento de Organización y Funciones del Fondepes, aprobado por Resolución Ministerial n.º 346-2012-PRODUCE, corresponde expedir la Resolución Jefatural mediante la cual se apruebe prestación adicional de obra n.º 06 y presupuesto deductivo vinculado n.º 05.

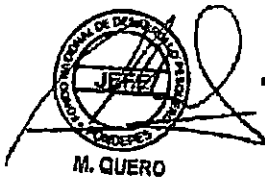

M. QUERO

Con los visados de la Gerencia General, de la Dirección General de Inversión Pesquera Artesanal y Acuícola, de la Oficina General de Planeamiento y Presupuesto, y de la Oficina General de Asesoría Jurídica, en lo que corresponde a sus respectivas competencias;

SE RESUELVE:



K. ESPINOZA

Artículo 1º.- Aprobar el expediente técnico de la prestación adicional de obra n.º 06 del Contrato n.º 025-2017-FONDEPES para la contratación de la ejecución de la obra «Mejoramiento y Recuperación de los servicios del Desembarcadero Pesquero Artesanal de Supe, distrito de Supe Puerto, provincia de Barranca, región Lima» por el monto de S/ 340,246.17 (trescientos cuarenta mil doscientos cuarenta y seis con 17/100 Soles) incluido IGV y el presupuesto deductivo vinculado n.º 05 por un monto de S/ 339,697.56 (trescientos treinta y nueve mil seiscientos noventa y siete con 56/100 Soles) incluido IGV, los cuales representan una incidencia acumulada individual equivalente a 1.58% del contrato original y una incidencia acumulada total de 6.98% del monto del contrato original, correspondiente a la obra en mención; cuyo nuevo monto contractual asciende a la suma de S/ 23'011,241.58 (veintitrés millones once mil doscientos cuarenta y uno con 58/100 Soles) incluido IGV de acuerdo a los fundamentos contenidos en el Memorando n.º 4829-2018-Fondepes/DIGENIPAA y el Informe n.º 289-2018-Fondepes-DIGENIPAA/AOEM/LATH, así como el Informe n.º 883-2018-FONDEPES/OGAJ, los mismos que forman parte integrante de la presente Resolución en calidad de anexos.



LABQ

Artículo 2º.- Autorizar la ejecución expediente técnico de la Prestación adicional de obra n.º 06 y su presupuesto deductivo vinculado n.º 05 aprobado en el artículo 1 de la presente resolución debiendo el Contratista Consorcio Marítimo del Norte, ampliar el monto de la garantía de fiel cumplimiento, como requisito para los pagos que correspondan a la prestación adicional, de corresponder, conforme a lo establecido en el numeral 175.14 del artículo 175 del Reglamento de la Ley de Contrataciones del Estado, aprobado por el Decreto Supremo n.º 350-2015-EF y modificado mediante el Decreto Supremo n.º 056-2017-EF.



Artículo 3º.- Notificar la presente Resolución y sus anexos al Consorcio Marítimo del Norte y al Supervisor CESEL S.A.; remitiéndose copias a la oficina general de Administración para que en coordinación con la Dirección General de Inversión Pesquera Artesanal y Acuícola ejecuten las acciones que permitan la suscripción de la adenda correspondiente al Contrato n.º 025-2017-FONDEPES.



N SUPANTA

Artículo 4º.- Disponer que en el acto de notificación de la presente Resolución y sus anexos, al Consorcio Marítimo del Norte, se le haga entrega del expediente técnico aprobado en el artículo 1º de la presente Resolución.

Artículo 5º.- Disponer que la Dirección General de Inversión Pesquera Artesanal y Acuícola, bajo responsabilidad funcional, en el plazo de 30 días calendarios posteriores a la emisión de la presente, emita un informe respecto de la existencia de responsabilidades por las presuntas deficiencias en la formulación y/o aprobación del expediente técnico de la Obra, para que conjuntamente con los antecedentes, sea remitido a la Secretaría Técnica de las Autoridades del Procedimiento Administrativo Disciplinario del Fondepes. En el



000282



RESOLUCIÓN JEFATURAL
N° 158-2018-FONDEPES/J

28 DIC. 2018

Lima,



supuesto que se determine la responsabilidad del proyectista que elaboró el mencionado expediente técnico, corresponderá a la Digenipaa determinar la existencia del daño o perjuicio generado al Fondepes, así como su cuantificación monetaria, debiendo comunicarse dicha situación a la Procuraduría Pública para que adopte las acciones correspondientes.

Artículo 6°.- Disponer que la Dirección General de Inversión Pesquera Artesanal y Acuicola, comunique al Sistema Nacional de Programación Multianual y Gestión de Inversiones la ejecución de la prestación adicional de obra n.º 06 y el presupuesto deductivo vinculado n.º 05.

Artículo 7.- Disponer que la presente Resolución se publique en el portal institucional de la Entidad.

Regístrese y comuníquese



FONDO NACIONAL DE DESARROLLO PESQUERO
FONDEPES

DR. MORGAN NICCOLO QUERO GAIME
JEFE

"Decenio de la Igualdad de Oportunidades para Mujeres y Hombres"
"Año del Diálogo y la Reconciliación Nacional"

INFORME N.º 883-2018-FONDEPES/OGAJ

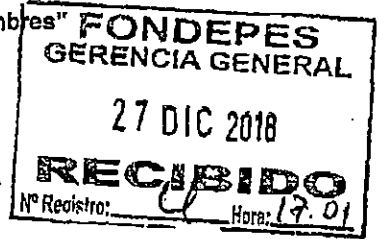

A : **ABG^{da}. KARLA ELIZABETH ESPINOZA MALATESTA**
Gerente General del Fondepes

Asunto : Prestación adicional de obra n.º 06 y presupuesto deductivo vinculado n.º 05 correspondiente al Contrato n.º 025-2017-FONDEPES para la «*Contratación de la ejecución de la obra: Mejoramiento y Recuperación de los servicios del Desembarcadero Pesquero Artesanal de Supe, distrito de Supe Puerto, provincia de Barranca, región Lima*»

Referencia : a) Memorando n.º 4829-2018-FONDEPES/DIGENIPAA
b) Informe n.º 289-2018-FONDEPES-DIGENIPAA/AOEM/LATH

Fecha : Lima, 27 de diciembre de 2018

Tengo a bien dirigirme a usted con relación a los documentos de la referencia, a fin de informar lo siguiente:

I. ANTECEDENTES:

- 1.1 El 22 de agosto de 2017, el Fondo Nacional de Desarrollo Pesquero (Fondepes) y el Consorcio Marítimo del Norte, integrado por las empresas Cefoisa Ingeniería y Construcción S.A.C, PCD S.A.C y Asphalt Technologies S.A.C. (Contratista) suscribieron el Contrato n.º 025-2017-FONDEPES para la «*Contratación de la ejecución de obra: Mejoramiento y Recuperación de los servicios del Desembarcadero Pesquero Artesanal de Supe, distrito de Supe Puerto, provincia de Barranca, región Lima*» (Obra) por el monto de S/ 21 509 091.48 (veintiún millones quinientos nueve mil noventa y uno con 48/100) incluido IGV, con un plazo de ejecución de 270 días calendario.
- 1.2 El 15 de setiembre de 2017, el Fondepes y la empresa CESEL S.A. (Supervisor) suscribieron el Contrato n.º 030-2017-FONDEPES para la contratación del servicio de consultoría de obra por paquete para la supervisión de la obra: «*Mejoramiento y recuperación de los servicios del desembarcadero pesquero artesanal de Supe, distrito de Supe Puerto, provincia de Barranca, región Lima*».
- 1.3 El 13 de diciembre de 2018, mediante Carta n.º 1398-2018-Fondepes/DIGENIPAA, la DIGENIPAA remitió al supervisor el «Expediente técnico del adicional n.º 06 y del deductivo vinculado n.º 05» para que emita opinión respecto a la viabilidad técnica del mismo.
- 1.4 El 18 de diciembre de 2018, mediante documento CSL.174302.PU.230.18.DPA.S el supervisor remitió al Fondepes el «Pronunciamiento respecto a viabilidad de solución técnica planteada en el Expediente Técnico del adicional n.º 06 y deductivo vinculado n.º 05 a través del cual concluyó viable la solución técnica al «Expediente técnico del Adicional n.º 06 y del Deductivo Vinculado n.º 05».
- 1.5 El 27 de diciembre de 2018, mediante Informe n.º 289-2018-FONDEPES-DIGENIPAA/AOEM/LATH la DIGENIPAA recomendó la aprobación del adicional de obra n.º 06 y del deductivo vinculado n.º 05.
- 1.6 El 27 de diciembre de 2018, mediante el Memorando n.º 4829-2018-FONDEPES/DIGENIPAA, el Director de la DIGENIPAA remitió el Informe n.º 289-





"Decenio de la Igualdad de Oportunidades para Mujeres y Hombres"
"Año del Diálogo y la Reconciliación Nacional"

000280

2018-FONDEPES-DIGENIPAA/AOEM/LATH a la Oficina General de Asesoría Jurídica (OGAJ) para que se proyecte resolutivo correspondiente.

II. BASE LEGAL:

- 2.1 Ley n.º 30225, Ley de Contrataciones del Estado, modificada por Decreto Legislativo n.º 1341, en adelante la Ley.
- 2.2 Decreto Supremo n.º 350-2015-EF, que aprueba el Reglamento de la Ley de Contrataciones del Estado, y modificado por Decreto Supremo n.º 056-2017-EF, en adelante el Reglamento.
- 2.3 Resolución Jefatural n.º 069-2016-FONDEPES/J, que aprueba delegación de facultades del Fondepes.

III. ANALISIS LEGAL:

De los presupuestos legales para la aprobación y ejecución de la prestación adicional de obra

- 3.1 El Anexo Único del Reglamento y la Directiva n.º 011-2016-CG/GPROD - Servicio de control previo de las prestaciones adicionales de obra, aprobada por Resolución de Contraloría n.º 147-2016-CG, definen el concepto de prestación adicional de obra del siguiente modo:

«Es aquella no considerada en el expediente técnico, ni en el contrato original, cuya realización resulta indispensable y/o necesaria para dar cumplimiento a la meta prevista de la obra principal y que da lugar a un presupuesto adicional.»

- 3.2 El artículo 34º de la Ley establece que las prestaciones adicionales de obra aprobadas durante la ejecución contractual configura un supuesto de modificación del contrato, conforme se desprende del siguiente texto:

«Artículo 34. Modificaciones al contrato

34.1 El contrato puede modificarse en los supuestos contemplados en la Ley y el reglamento, por orden de la Entidad o a solicitud del contratista, para alcanzar la finalidad del contrato de manera oportuna y eficiente. En este último caso la modificación debe ser aprobada por la Entidad. Dichas modificaciones no deben afectar el equilibrio económico financiero del contrato; en caso contrario, la parte beneficiada debe compensar económicamente a la parte perjudicada para restablecer dicho equilibrio, en atención al principio de equidad.

34.2 Excepcionalmente y previa sustentación por el área usuaria de la contratación, la Entidad puede ordenar y pagar directamente la ejecución de prestaciones adicionales en caso de bienes, servicios y consultorías hasta por el veinticinco por ciento 25% del monto del contrato original, siempre que sean indispensables para alcanzar la finalidad del contrato.

Asimismo, puede reducir bienes, servicios u obras hasta por el mismo porcentaje.

34.3 Tratándose de obras, las prestaciones adicionales pueden ser hasta por el quince por ciento (15%) del monto total del contrato original; restándole los presupuestos deductivos vinculados. Para tal efecto, los pagos correspondientes son aprobados por el Titular de la Entidad.»

- 3.3 En esa línea, el artículo 175º del Reglamento dispone que sólo corresponde autorizar la ejecución de prestaciones adicionales de obra cuando previamente se cuente con la certificación de crédito presupuestario y la resolución del Titular de la Entidad y en los casos en que sus montos, restándole los presupuestos deductivos vinculados, sean



"Decenio de la Igualdad de Oportunidades para Mujeres y Hombres"
"Año del Diálogo y la Reconciliación Nacional"

000279

iguales o no superen el quince por ciento (15%) del monto del contrato original. Cabe precisar que el artículo en mención establece que los contratos de obra bajo el sistema de contratación de precios unitarios que requieran mayores metrados no requieren autorización previa para su ejecución, pero sí para su pago.

- 3.4 En cuanto a la tramitación de las prestaciones adicionales de obra el artículo 175° del Reglamento señala lo siguiente:

«(...) 175.2. La necesidad de ejecutar una prestación adicional de obra debe ser anotada en el cuaderno de obra, sea por el contratista, a través de su residente, o por el inspector o supervisor, según corresponda. En un plazo máximo de cinco (5) días contados a partir del día siguiente de realizada la anotación, el inspector o supervisor, según corresponda, debe comunicar a la Entidad la anotación realizada, adjuntando un informe técnico que sustente su posición respecto a la necesidad de ejecutar la prestación adicional. Además, se requiere el detalle o sustento de la deficiencia del expediente técnico o del riesgo que haya generado la necesidad de ejecutar la prestación adicional.»

175.3. En el caso de obras convocadas por paquete que, por su naturaleza, no cuenten con inspector o supervisor a tiempo completo, el plazo al que se refiere el numeral anterior se computa a partir del primer día posterior a la fecha de la anotación, en que, según la programación, corresponda al inspector o supervisor estar en la obra.

175.4. La Entidad debe definir si la elaboración del expediente técnico de la prestación adicional de obra está a su cargo, a cargo de un consultor externo o a cargo del inspector o supervisor, este último en calidad de prestación adicional, aprobada conforme al procedimiento previsto en el artículo 139. Para dicha definición, la Entidad debe tener en consideración la naturaleza, magnitud, complejidad, entre otros aspectos relevantes de la obra principal, así como la capacidad técnica y/o especialización del inspector o supervisor, cuando considere encargarle a este la elaboración del expediente técnico».

- 3.5 Por su parte, la Dirección Técnico Normativa (DTN) del Organismo Supervisor de las Contrataciones del Estado (OSCE), a través de la Opinión n.° 208-2016-DTN, sobre el artículo 175° del Reglamento, señala lo siguiente:

«(...) la normativa ha previsto determinados requisitos con los cuales la Entidad debe contar de forma previa a la aprobación de una prestación adicional de obra, los mismos que se encuentran en función del monto o incidencia que tenga este adicional sobre el monto del contrato original.

Así, la certificación de crédito presupuestario o previsión presupuestal se otorga por el monto del adicional restándole los presupuestos deductivos vinculados, y, por su parte, la aprobación estará a cargo del Titular de la Entidad, cuando el monto no exceda el quince por ciento (15%) del monto del contrato original, caso contrario corresponderá aplicar lo previsto en el artículo 176 del Reglamento, donde se requiere la autorización expresa de la Contraloría General de la República.

Sobre el particular, es importante resaltar que la aprobación de una prestación adicional conlleva la erogación de mayores gastos a cuenta de la Entidad, motivo por el cual es indispensable corroborar de forma previa a su aprobación, la existencia de presupuesto que pueda asignarse a la ejecución de dicho adicional al contrato, con lo cual la Entidad, garantiza el cumplimiento del pago al contratista (...).

- 3.6 De los dispositivos legales expuestos y la citada opinión se desprende que con la finalidad de autorizar la ejecución de prestaciones adicionales resulta indispensable cumplir con el procedimiento establecido en el artículo 175° del Reglamento, esto es, i) anotar la necesidad de la prestación adicional ya sea por el contratista o por el supervisor y/o inspector en el cuaderno de obra; ii) contar con la disponibilidad





"Decenio de la Igualdad de Oportunidades para Mujeres y Hombres"
"Año del Diálogo y la Reconciliación Nacional"

000213

presupuestal; iii) la comunicación del inspector o supervisor a la Entidad de la anotación realizada adjuntando un informe técnico que sustente su posición respecto de la necesidad de ejecutar la prestación adicional; iv) la decisión de la Entidad sobre quien estará a cargo de la elaboración del expediente técnico de la prestación adicional de obra; v) la pactación de precios, de ser el caso; vi) el informe del supervisor o inspector en el que se pronuncie sobre la viabilidad de la solución técnica planteada en el expediente técnico, en caso que este haya sido elaborado por la Entidad o un consultor externo y; vii) el pronunciamiento de la Entidad sobre la procedencia de la ejecución de la prestación adicional de obra.

3.7 Al respecto, según lo señalado por la DIGENIPAA en el Informe n.º 289-2018-FONDEPES-DIGENIPAA/AOEM/LATH en su calidad de área usuaria y órgano técnico, se cumplen con los requisitos establecidos en el artículo 34º de la Ley y el artículo 175º del Reglamento, bajo los siguientes argumentos:

- i. **Anotación en el cuaderno de obra sobre la necesidad de ejecutar una prestación adicional y comunicación de la supervisión a la Entidad sobre la anotación en el cuaderno de obra, adjuntando un informe técnico que sustente su posición respecto de la necesidad de ejecutar la prestación adicional:**

«Con Asiento N° 397 del 14 de agosto del 2018, reitera las consultas de las instalaciones eléctricas de Media Tensión e indica que los mismos representan adicionales por deficiencias del expediente técnico.»

Con Carta CLS. 174302. PU. DPA.S.72.18. de fecha de recepción 15 de agosto del 2018 e Informe CSL-174302-PU-ESP.26.18 adjunto, la supervisión de la obra CESEL SA comunica, anotaciones del Cuaderno de Obra donde el contratista de obra manifiesta que existen observaciones y consultas de las instalaciones eléctricas de Media Tensión que requieren ser aclaradas y que además los mismos representan adicionales por deficiencias del expediente técnico».(sic)

- ii. **La definición de la Entidad respecto del encargado de elaborar el expediente técnico de la prestación adicional, teniendo en consideración la naturaleza, magnitud, complejidad, entre otros aspectos relevantes de la obra principal, así como la capacidad técnica y/o especialización del Inspector o supervisor, cuando considere encargarle a éste la elaboración del expediente técnico:**

Mediante Memorando n.º 4368-2018-FONDEPES/DIGENIPAA, de fecha 12 de diciembre de 2018, el Director General de Inversión Pesquera Artesanal y Acuícola, encargó al Área de Estudios y Proyectos elaborar el Expediente Técnico del adicional de obra n.º 06 y deductivo vinculado n.º 05 referido al "Sistema de utilización en media tensión 20kV", para la obra: "Mejoramiento y recuperación de los servicios del Desembarcadero Pesquero Artesanal de Supe, distrito de Supe".

- iii. **Informe de la supervisión en el que se pronuncie sobre la viabilidad de la solución técnica planteada en el expediente técnico de la prestación adicional, cuando no se le encargo la elaboración a la supervisión:**

El 18 de diciembre de 2018, mediante Informe Especial n.º 43 adjunto al documento CSL.174302.PU.230.18.DPA.S, el Supervisor de la Obra remitió a Fondepes su opinión acerca de la solución técnica planteada en el expediente técnico de adicional de obra n.º 6 y su presupuesto deductivo vinculante n.º 5 dando la conformidad de la misma.



"Decenio de la Igualdad de Oportunidades para Mujeres y Hombres"
"Año del Diálogo y la Reconciliación Nacional"

000217

iv. Cuantificación del presupuesto de la prestación adicional según pactación de precios o precios del contrato, según corresponda:

El 20 de diciembre de 2018 el Ing. Luis Alberto Barbieri Quino, director general de la Dirección General de Inversión Pesquera Artesanal y Acuícola del Fondepes y el Sr. Roberto Carlos Alvarado Loyola, representante legal de Consorcio Marítimo del Norte suscribieron el «Acta de precios unitarios pactados» sobre aquellas partidas cuyos precios unitarios no estaban previstas en el presupuesto de Obra.

v. Incidencia de la prestación adicional de hasta el quince por ciento (15%) del monto total del contrato original, restándole los presupuestos deductivos vinculados:

El monto del Presupuesto Adicional n.º 06 asciende a S/ 340,246.17, incluido el IGV, que representa una incidencia de 1.58% respecto al monto contractual y; el Presupuesto Deductivo Vinculante n.º 05 asciende a S/ 339,697.56, incluido el IGV, que representa una incidencia de 1.58% respecto al monto contractual.

Debemos tener en consideración que anteriormente se aprobaron la prestación adicional n.º 01 y su presupuesto deductivo vinculado 01, prestación adicional 02, prestación adicional n.º 03 y su presupuesto deductivo vinculado n.º 02, prestación adicional n.º 04 y su presupuesto deductivo vinculado n.º 03, prestación adicional n.º 05 y su presupuesto deductivo vinculado n.º 04 y, el presente trámite de aprobación del adicional n.º 06 y deductivo vinculado n.º 05 hacen que la incidencia total acumulada sea del 6.98% del presupuesto contratado.

«5.6 Monto e Incidencia del Adicional de Obra N° 06

DESCRIPCION	MONTOS	INDICENCIA
MONTO CONTRATADO	21'509,091.48	100.00%
ADICIONAL DE OBRA N° 06 (MEDIA TENSION)	340,246.17	1.58 %

5.7 Montos e Incidencia Acumulada de los Adicionales de Obra

DESCRIPCION	MONTOS	INDICENCIA
MONTO CONTRATADO	21'509,091.48	
ADICIONAL DE OBRA N° 01	2'213,942.02	10.29%
DEDUCTIVO VINCULADO N° 01	-1'879,271.36	-8.74%
ADICIONAL DE OBRA N° 02	160,884.74	0.75 %
ADICIONAL DE OBRA N° 03 (II.EE.)	676,072.37	3.14 %
DEDUCTIVO VINCULADO N° 02	-242,870.31	-1.13%
ADICIONAL DE OBRA N°04 (II.SS.)	417,954.90	1.94 %
DEDUCTIVO VINCULADO N° 03	-220,209.97	-1.02%
ADICIONAL DE OBRA N°05 (OBRAS MENORES)	562,775.06	2.62 %
DEDUCTIVO VINCULADO N° 03	-187,675.96	-0.87%
ADICIONAL DE OBRA N°06 (MEDIA TENSION)	340,246.17	1.58 %
DEDUCTIVO VINCULADO N° 05	-339,697.56	-1.58%
TOTAL	1'502,150.10	6.98 %

MONTO VIGENTE	23'011,241.58	106.98 %
----------------------	----------------------	-----------------

(...))»



"Decenio de la Igualdad de Oportunidades para Mujeres y Hombres"
"Año del Diálogo y la Reconciliación Nacional"

000276

vi. **La certificación presupuestarla:**

El 27 de diciembre de 2018, mediante Memorando n.º 634-218-FONDEPES/OGPP la Oficina General de Planeamiento y Presupuesto otorgó la Certificación de Crédito Presupuestario con Nota n.º 0000004769 por un monto de S/ 548.61 para el Adicional de Obra n.º 06 en cumplimiento del numeral 175.1 del artículo 175º del Reglamento de la Ley de Contrataciones del Estado».

vii. **Determinación de la Entidad sobre la necesidad de aprobar la prestación adicional de obra para alcanzar la finalidad del contrato de manera oportuna y eficiente:**

«Ante la falta de respuesta del Proyectista y con el objetivo de alcanzar la finalidad del contrato al contar con un proyecto de Media Tensión confiable para la alimentación del servicio eléctrico en el DPA Supe y que esté de acuerdo a la demanda instalada requerida para el correcto funcionamiento del sistema eléctrico de las edificaciones, los equipos eléctricos y/o electromecánicos; se realizó una revisión de la potencia instalada y la demanda máxima, la cual evidenció deficiencias en los cálculos y la necesidad del rediseño; condicionado además por la falta de factibilidad y punto de diseño; esta situación obliga a realizar el trámite de solicitud de Factibilidad y Punto de Diseño ante el concesionario eléctrico ENEL y la elaboración por un tercero del expediente técnico del "Sistema de Utilización en Media Tensión 20 kV (Operación Inicial 10 kV)", de acuerdo con la disposición contenida en la norma R.D. N° 018-2002 EM/DGE "Norma de Procedimientos para la Elaboración de Proyectos y Ejecución de Obras en Sistemas de Distribución y Sistemas de Utilización en Media Tensión".

Mediante Carta 1552831 del 12 de diciembre del 2018, la empresa concesionaria ENEL, otorga conformidad al expediente del proyecto del "Sistema de Utilización en Media Tensión 20 kV (Operación Inicial 10 kV)" del DPA de Supe, elaborado por el consultor Ing. Juan Cabezas Huamani, proyecto que modifica el expediente de media tensión.

Con Memorando N° 360-2018-FONDEPES/DIGENIPAA/AEP del 21.12.2018, el Área de Estudios y Proyectos, deriva el expediente del Adicional de Obra N° 06 y Deductivo Vinculado N° 05 al Área de Obra, Equipamiento y Mantenimiento por la modificación de la media tensión.

En conclusión, el Adicional de Obra N° 06 y deductivo Vinculado N° 05, se justifica para subsanar los errores, deficiencias y omisiones del expediente técnico en los planos, memoria descriptiva y cálculos justificativos de la especialidad de instalaciones eléctricas de la media tensión del DPA de Supe, por el cual se debe deslindar responsabilidades (...)» sic.

Asimismo, en el Informe n.º 289-2018-FONDEPES-DIGENIPAA/AOEM/LATH, la DIGENIPAA, como consecuencia del análisis efectuado señaló lo siguiente: «(...) por ser necesario para alcanzar la finalidad del contrato en la ejecución del proyecto PIP N° 182813: "MEJORAMIENTO Y RECUPERACION DE LOS SERVICIOS DEL DESEMBARCADERO PESQUERO ARTESANAL DE SUPE, DISTRITO DE SUPE PUERTO, PROVINCIA DE BARRANCA, REGION LIMA", se recomienda el trámite de aprobación del Adicional de obra N° 06, por un monto de S/. 340,246.17, monto que incluye el IGV y que representa el 1.58% del contrato y el Deductivo Vinculado N° 05 por un monto de S/. 339,697.56, monto que incluye el IGV y que representa el 1.58% del contrato de obra (...)»



"Decenio de la Igualdad de Oportunidades para Mujeres y Hombres"
"Año del Diálogo y la Reconciliación Nacional"

000275

viii. Vinculación entre el Presupuesto Adicional De Obra y el Presupuesto Deductivo Vinculado:

Al respecto la Digenipaa incluyó en su Informe el siguiente cuadro de vinculación de partidas entre el Presupuesto Adicional de Obra n.º 6 y el Presupuesto Deductivo Vinculado n.º 5:

5.4 Detalle de la vinculación del Presupuesto Adicional N° 06 con consultas en Cuaderno de Obra e Informes.

DETALLE DE LA VINCULACION DEL PRESUPUESTO ADICIONAL N°06 CON LAS CONSULTAS DE OBRA		
DESCRIPCIÓN	VINCULO O ANTECEDENTE	
01	INSTALACIONES ELECTRICAS	ASENTO N°20 DEL CUADERNO DE OBRA DEL 22.09.2017 DEL CONTRATISTA.
0101	TRABAJOS PRELIMINARES	
0102	ESTRUCTURA DE SISTEMA DE PROTECCION CON RECLOSER	ASENTO N°353 DEL CUADERNO DE OBRA DEL 09.06.2018 DEL CONTRATISTA.
0103	RED AEREA EN 10 KV	
0104	RED SUBTERRANEA	
0105	BIZONES	ASENTO N°397 DEL CUADERNO DE OBRA DEL 11.08.2018 DEL CONTRATISTA.
0106	CABLES Y CONDUCTORES	
0107	TERMINALES TERMOCONTRAI BLES	
0108	EQUIPAMIENTO DE SUBESTACION	CARTA CSL-74302-PU-DPA-S.72.18 DEL 15.08.2018 DE LA SUPERVISION.
0109	PUESTA A TIERRA	
0110	SEÑALIZACION	
0111	EQUIPOS DE PROTECCION Y MANIOBRAS	INFORME CSL-74302-PU-ESP.28.18 DEL 15.08.2018 DE LA SUPERVISION.
0112	PRUEBAS ELECTRICAS Y PUESTA EN SERVICIO	
0113	VARIOS	

5.5 Detalle de la vinculación del Presupuesto Adicional N° 06 y Deductivo Vinculado N° 05.



VINCULACION DEL PRESUPUESTO ADICIONAL N°06 Y DEDUCTIVO VINCULANTE N°05			
INSTALACIONES ELECTRICAS DE MEDIA TENSION			
ADICIONAL N°06	DEDUCTIVO N°05		
01	INSTALACIONES ELECTRICAS MEDIA TENSION	04.02	MEDIA TENSION
01.01	TRABAJOS PRELIMINARES	04.02.01	OBRAS PRELIMINARES
01.02	ESTRUCTURA DE SISTEMA DE PROTECCION CON RECLOSER	04.02.02	MOVIMIENTO DE TIERRAS
01.03	RED AEREA EN 10 KV	04.02.03	CONDUCTOS Y CANALIZACIONES
01.04	RED SUBTERRANEA	04.02.04	MONTAJE DE POSTES DE CONCRETO
01.05	BIZONES	04.02.05	MONTAJE DE ARRANOS
01.06	CABLES Y CONDUCTORES	04.02.06	MONTAJE DE CONDUCTORES
01.07	TERMINALES TERMOCONTRAI BLES	04.02.07	INSTALACION DE PUESTA A TIERRA
01.08	EQUIPAMIENTO DE SUBESTACION	04.02.08	INSTALACION DE SUBESTACION ELECTRICA
01.09	PUESTA A TIERRA	04.02.09	INSTALACION DE SISTEMA DE MEDICION
01.10	SEÑALIZACION	04.02.10	PRUEBAS Y PUESTA EN SERVICIO
01.11	EQUIPOS DE PROTECCION Y MANIOBRAS		
01.12	PRUEBAS ELECTRICAS Y PUESTA EN SERVICIO		
01.13	VARIOS		

Nota: Cabe señalar que se ha verificado por parte de la DIGENIPAA que los informes y documentos señalados en los cuadros precedentes corroboran la efectiva vinculación entre el Presupuesto Adicional de Obra N° 06 y el Deductivo Vinculado N° 05 del expediente de Media Tensión en cada una de las partidas respectivas.

3.9. En razón de lo expuesto, en virtud de lo dispuesto en la normativa de contratación pública que faculta a la Entidad a ordenar al contratista la ejecución de prestaciones

adicionales de obra, cuando considere que ello resulta necesario para alcanzar la finalidad del contrato y, en última instancia, la satisfacción del interés público que subyace a la contratación, concurren los presupuestos legales para la aprobación del expediente técnico de la prestación adicional de obra n.º 06 y el presupuesto deductivo vinculado n.º 05, en los términos planteados por la DIGENIPAA en el Informe n.º 289-2018-FONDEPES-DIGENIPAA/AOEM/LATH.

- 3.10. Cabe recordar que al momento de notificar al Consorcio Marítimo del Norte la Resolución a través de la cual se apruebe la ejecución del expediente técnico de la prestación adicional de obra n.º 06 deberá entregarse el respectivo expediente técnico de dicha prestación adicional y del deductivo vinculante. Asimismo, debe precisarse que las prestaciones adicionales, reducciones y los mayores o menores metrados que se produzcan durante la ejecución de proyectos de inversión pública deben ser comunicados por la Entidad a la autoridad competente del Sistema Nacional de Inversión Pública.

Del plazo para emitir pronunciamiento

- 3.11 El artículo 175º del Reglamento dispone que la Entidad cuenta con doce (12) días hábiles para emitir y notificar al contratista la resolución a través de la cual se pronuncie sobre la procedencia de la ejecución de la prestación adicional de obra, contados a partir de la remisión de la opinión del supervisor respecto de la solución técnica planteada en el expediente técnico en caso el mismo haya sido elaborado por la Entidad o un consultor externo o en su defecto, desde la remisión del expediente técnico, cuando este ha sido elaborado por el supervisor en calidad de prestación adicional.
- 3.12 En el presente caso, el expediente técnico de la Prestación Adicional de Obra n.º 06 y su presupuesto Deductivo Vinculado n.º 05 de la obra fue elaborado por la Entidad, cuya opinión favorable del Supervisor fue recibido por la Entidad el 18 de diciembre de 2018, por lo que corresponde al Fondepes emitir y notificar al Contratista su decisión de aprobar la referida prestación adicional de obra n.º 06 y su presupuesto deductivo vinculado n.º 05 de obra hasta el 7 de enero de 2018.

Del funcionario competente para autorizar prestaciones adicionales de obra

- 3.13 El artículo 8 de la Ley precisa que *"el Titular de la Entidad puede delegar, mediante resolución, la autoridad que la presente norma le otorga. Puede delegar, al siguiente nivel de decisión, las autorizaciones de prestaciones adicionales de obra"*. Sin embargo, no se advierte que el Titular del FONDEPES haya delegado la facultad de aprobar adicionales, por lo que, la aprobación de prestaciones adicionales de obra corresponde exclusivamente a su competencia.

De la Responsabilidad

- 3.14 De corresponder, se recomienda iniciar las acciones conducentes al deslinde de responsabilidades por las deficiencias en el expediente técnico original que motivaron la prestación adicional de obra n.º 06 y su presupuesto deductivo vinculado n.º 05 de la obra.
- 3.15 Cabe precisar que la presente evaluación de la prestación adicional de obra n.º 06 y su presupuesto deductivo vinculado n.º 05 de la obra tiene únicamente por objeto evaluar la viabilidad legal del acto de aprobación solicitado, no siendo competencia de esta oficina general emitir opinión alguna sobre aspectos técnicos relacionados a su aprobación y ejecución analizados por la DIGENIPAA, así como de aspectos presupuestales correspondientes a la prestación adicional requerida, y demás actores competentes.



"Decenio de la Igualdad de Oportunidades para Mujeres y Hombres"
"Año del Diálogo y la Reconciliación Nacional"

000273

IV CONCLUSIONES Y RECOMENDACIONES:

Estando a lo expuesto en el Informe n.º 289-2018-FONDEPES-DIGENIPAA/AOEM/LATH esta Oficina General de Asesoría Jurídica opina y recomienda que:

- 4.1 Concurren los presupuestos legales requeridos para continuar con el trámite de aprobación de la prestación adicional de obra n.º 06 y su presupuesto deductivo vinculado n.º 05 de la obra.
- 4.2 Se recomienda efectuar el deslinde de responsabilidades por las deficiencias en el Expediente Técnico de la Obra que generaron la aprobación de la prestación adicional n.º 06 y su presupuesto deductivo vinculado n.º 05 de la obra.

Atentamente,



[Handwritten signature]

Pedro Martín Hurtado Castillo
de la Oficina General de Asesoría Jurídica
Fondo Nacional de Desarrollo Pesquero - FONDEPES

PMHC/frba

"Decenio de la Igualdad de Oportunidades para Mujeres y Hombres"
"Año del Diálogo y la Reconciliación Nacional"

000272

MEMORANDO N° 4829-2018-FONDEPES/DIGENIPAA

A : Abog. Walther Javier Iberos Guevara
Jefe de la Oficina General de Asesoría Jurídica

Asunto : Resolución de aprobación del Adicional de Obra N° 06 y Deductivo Vinculado N° 05.
Licitación Pública N° 0001-2017-FONDEPES
Contrato N° 025-2017-FONDEPES
"MEJORAMIENTO Y RECUPERACION DE LOS SERVICIOS DEL DESEMBARCADERO PESQUERO ARTESANAL DE SUPE, DISTRITO DE SUPE PUERTO, PROVINCIA DE BARRANCA, REGION LIMA"

Referencia : a) Carta CSL.174302.PU.230.18.DPA.S del 18.12.2018.
b) INFORME N° CSL.174302.PU.ESP.43
c) MEMORANDO N° 360-2018-FONDEPES/DIGENIPAA/AEP.
d) INFORME N° 289-2018-FONDEPES-DIGENIPAA/LATH
e) Expediente Adicional N° 06 y Deductivo Vinculado N° 05 – Media Tensión

Fecha : Lima, **27 DIC 2018**

Es grato dirigirme a usted, para solicitarle tenga a bien autorizar a quien corresponda elabore la resolución correspondiente para la aprobación del Adicional de Obra N° 06 de las Instalaciones Eléctricas del Sistema de Utilización en Media Tensión la obra: "MEJORAMIENTO Y RECUPERACION DE LOS SERVICIOS DEL DESEMBARCADERO PESQUERO ARTESANAL DE SUPE, DISTRITO DE SUPE PUERTO, PROVINCIA DE BARRANCA, REGION LIMA" y el Deductivo Vinculado N° 05 correspondiente; para ello se adjunta el informe de la referencia d) el cual hago mío en toda su extensión. La aprobación de la misma permitirá alcanzar la finalidad de contrato y se ha cumplido con el procedimiento establecido en el artículo 175° del Reglamento de Contrataciones del Estado.

En ese sentido, se solicita se emita pronunciamiento mediante la resolución respectiva y se notifique al contratista CONSORCIO MARITIMO DEL NORTE y supervisión CESEL SA, en una fecha no mayor al 30.12.2018, para lo cual se adjuntan a la presente los documentos de la referencia a), b) c) d) y e).

Atentamente,

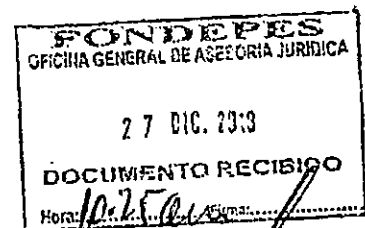

FONDEPES
Ing. Luis Alberto Barbieri Quino
Director General de Inversión
Pesquera Artesanal Y Acuicola



LBQ/LATH

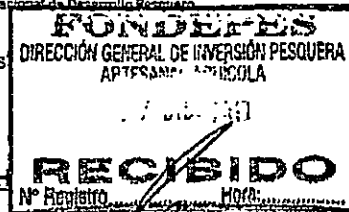

"Decenio de la Igualdad de Oportunidades para Mujeres y Hombres
"Año del Diálogo y la Reconciliación Nacional"



INFORME N° 289-2018-FONDEPES-DIGENIPAA/AOEM/LATH

Atención : **ING. LUIS ALBERTO BARBIERI QUINO**
Director General de Inversión Pesquera, Artesanal y Acuicola.

Asunto : **Prestación Adicional de Obra N° 06 y Deductivo Vinculado N° 05 DPA de Supe.**
LICITACION PUBLICA: N° 0001-2017-FONDEPES.

Referencia : a) Memorando N° 360-2018-FONDEPES/DIGENIPAA/AEP del 21.12.18
b) Expediente Técnico de la Prestación Adicional N° 06 y Deductivo Vinculado N° 05.
c) CONTRATO N° 025-2017-FONDEPES del Contratista.

Fecha : Diciembre, 27 del 2018.

000271

De mi consideración:

Es grato dirigirme a usted para evaluar y dar trámite a la solicitud de aprobación de la Prestación Adicional de Obra N° 06 y Deductivo Vinculado N° 05, por la modificación del sistema de utilización en media tensión 20kv (Inicial 10 kv) de la obra: "Mejoramiento y Recuperación de los Servicios del Desembarcadero Pesquero Artesanal de Supe, Distrito de Supe Puerto, Provincia de Barranca, Región Lima"; el cual estará a cargo de la empresa contratista CONSORCIO MARITIMO DEL NORTE, en atención y concordancia con el documento a) de la referencia; al respecto puedo informar:

I. DATOS GENERALES DE LA OBRA

Proceso : LP. N° 0001-2017-FONDEPES (1ra. Convocatoria)
Código SNIP N° : 182813
Contrato : N° 025-2017-FONDEPES
Obra : "Mejoramiento y Recuperación de los Servicios del Desembarcadero Pesquero Artesanal de Supe, Distrito de Supe Puerto, Provincia de Barranca, Región Lima".
Sistema : A precios Unitarios
Monto Obra : S/. 21'509,091.48 (incluye IGV)
Adic. Obra 01 : S/. 2'213,942.02 – R.J. N° 008-2018-FONDEPES/J del 18.01.18
Deduc. Vinc. 01 : S/. -1'879,271.36
Adic. Obra 02 : S/. 160,884.74 – R.J. N° 052-2018-FONDEPES/J del 18.05.18
Adic. Obra 03 : S/. 676,072.37 – R.J. N° 094-2018-FONDEPES/J del 22.08.18
Deduc. Vinc. 02 : S/. -242,870.31
Adic. Obra 04 : S/. 417,954.90 – R.J. N° 095-2018-FONDEPES/J del 22.08.18
Deduc. Vinc. 03 : S/. -220,209.97
Adic. Obra 05 : S/. 562,775.06 – R.J. N° 133-2018-FONDEPES/J del 26.10.18
Deduc. Vinc. 04 : S/. -187,675.96



LUIS ALBERTO TELLO HIDALGO
INGENIERO CIVIL
Reg. CIP N° 39250



000270

Total Adicional :	S/. 1'501,601.49 (6.98%)
Monto Vigente :	S/. 23'010,692.97 (incluye IGV)
Contratista :	CONSORCIO MARITIMO DEL NORTE
Residente :	Ing. Daniel J. Morales Vivanco.
Supervisión :	CESEL S.A.
Supervisor :	Ing. Ludwing Carrasco Bustamante
Fecha de Inicio :	19 de setiembre del 2017
Plazo Ejecución :	270 días calendario
Término :	15 de junio del 2018
Ampliac. N° 03 :	42 d.c. (Aprobada con Resolución de S.G. N° 028-2018-FONDEPES/SG).
Término :	27 de julio del 2018.
Ampliac. N° 04 :	32 d.c. (Aprobada con Resolución de S.G. N° 029-2018-FONDEPES/SG).
Término :	28 de agosto del 2018.
Ampliac. N° 05 :	28 d.c. (Aprobada con Resolución de S.G. N° 110-2018-FONDEPES/SG)
Término :	25 de setiembre del 2018.
Ampliac. N° 08 :	52 d.c. (Aprobada con Resolución de S.G. N° 171-2018-FONDEPES/SG).
Término :	16 de noviembre del 2018.
Ampliac. N° 10 :	44 d.c. Resolución de S.G. N° 215-2018-FONDEPES/SG del 30.11.2018.
Fecha Término :	30 de diciembre del 2018

II. ANTECEDENTES

Generales

- Mediante ADP N° 10-2014-FONDEPES-CSF/GCV se convoca al proceso de selección para la Elaboración del Expediente Técnico: "MEJORAMIENTO Y RECUPERACIÓN DE LOS SERVICIOS DEL DESEMBARCADERO PESQUERO ARTESANAL DE SUPE, DISTRITO DE SUPE PUERTO, PROVINCIA DE BARRANCA, REGION LIMA" y como resultado de este proceso se otorga la Buena Pro a la empresa CONSORCIO SAN FRANCISCO, según el Contrato N° 071-2014-FONDEPES/OGA.
- Con Carta N° 180-2015-FONDEPES/SG del 06.08.2015, se remite al CONSORCIO SAN FRANCISCO la Resolución de Secretaría General N° 112-2015-FONDEPES/SG, en el cual se aprueba el expediente técnico del proyecto de inversión pública denominado "MEJORAMIENTO Y RECUPERACIÓN DE LOS SERVICIOS DEL DESEMBARCADERO PESQUERO ARTESANAL DE SUPE, DISTRITO DE SUPE PUERTO, PROVINCIA DE BARRANCA, REGION LIMA".
- Con fecha 24 de Julio del 2017, el Comité de Selección como resultado del Proceso de Selección LICITACION PUBLICA N° 0001-2017-FONDEPES para la ejecución de la obras en paquete: "MEJORAMIENTO INTEGRAL DEL DESEMBARCADERO PESQUERO ARTESANAL DE HUACHO, DISTRITO DE HUACHO, PROVINCIA DE HUAURA, REGION LIMA" y "MEJORAMIENTO Y RECUPERACION DE LOS SERVICIOS DEL DESEMBARCADERO PESQUERO ARTESANAL DE SUPE, DISTRITO DE SUPE PUERTO, PROVINCIA DE BARRANCA, REGION LIMA", adjudico la Buena Pro al CONSORCIO MARITIMO DEL NORTE, integrado por las empresas CEFOISA INGENIERIA Y CONSTRUCCION S.A.C, PCD S.A.C Y ASPHALT TECHNOLOGIES S.A.C; suscribiéndose el Contrato N° 024-2017-FONDEPES y el Contrato N° 025-2017-FONDEPES respectivamente, con fecha 22 de agosto del 2017.





- Con fecha 29 de agosto del 2017, el Comité de Selección como resultado del Proceso de Selección CONCURSO PUBLICO N° 0001-2017-FONDEPES para la Contratación del Servicio de Consultoría de Obra por Paquete para la Supervisión de la siguientes obra: "MEJORAMIENTO INTEGRAL DEL DESEMBARCADERO PESQUERO ARTESANAL DE HUACHO, REGIÓN LIMA, PROVINCIA DE HUAURA, DISTRITO DE HUACHO" y "MEJORAMIENTO Y RECUPERACIÓN DE LOS SERVICIOS DEL DESEMBARCADERO PESQUERO ARTESANAL DE SUPE, DISTRITO DE SUPE", adjudico la Buena Pro a la empresa CESEL S.A; suscribiendo con fecha 15 de setiembre del 2017 el Contrato N° 029-2017-FONDEPES por el monto de S/. 1'777,720.87, con un plazo del servicio por 300 días calendario para el DPA de Huacho y Contrato N° 030-2017-FONDEPES por el monto de S/. 1'651,890.27, con un plazo del servicio por 270 días calendario para el DPA de Supe.

Específicas sobre la Prestación Adicional de Obra N° 06

- Con fecha 19 de setiembre del 2017, se inicia al plazo de ejecución de la obra en concordancia con el artículo 152° del Reglamento de la Ley de Contrataciones del Estado, el cual es refrendado por el contratista mediante Asiento N° 01 en el Cuaderno de Obra.
- Durante el proceso de ejecución de la obra, el contratista ha formulado vía cuaderno de Obra (Asiento N° 20 del 22.09.2017, Asiento N° 353 del 09.06.2018), consultas y observaciones al proyecto respecto de la partida de **MEDIA TENSION**, específicamente por la capacidad del transformador de la subestación y por no contar con metraños, falta de **FACTIBILIDAD Y PUNTO DE DISEÑO** que otorga el Concesionario ENEL. Así mismo, por las incompatibilidades entre planos, especificaciones técnicas y memoria descriptiva, documentos que conforman el proyecto de la media tensión.
- Con Asiento N° 397 del 14 de agosto del 2018, reitera las consultas de las instalaciones eléctricas de Media Tensión e indica que los mismos representan adicionales por deficiencias del expediente técnico
- Con Carta CLS. 174302. PU. DPA.S.72.18. de fecha de recepción 15 de agosto del 2018 e Informe CSL-174302-PU-ESP.26.18 adjunto, la supervisión de la obra CESEL SA comunica, anotaciones del Cuaderno de Obra donde el contratista de obra manifiesta que existen observaciones y consultas de las instalaciones eléctricas de Media Tensión que requieren ser aclaradas y que además los mismos representan adicionales por deficiencias del expediente técnico.
- Mediante Carta N° 915-2018-FONDEPES/DIGENIPAA del 20 de agosto del 2018 e Informe N° 169-2017-FONDEPES-DIGENIPAA/LATH adjunto, se solicita al consultor CONSORCIO SAN FRANCISCO absuelva las consultas planteadas por el contratista sobre la media tensión.
- Mediante Memorando N° 4368-2018-FONDEPES/DIGENIPAA, de fecha 12 de diciembre de 2018, el Director General de Inversión Pesquera Artesanal y Acuícola, encarga al Área de Estudios y proyectos la elaboración del Expediente Técnico del Adicional de Obra N° 06 y Deductivo vinculado N° 05 referido a la "Modificación de la Red de Media Tensión", para la obra: "Mejoramiento y Recuperación de los Servicios del desembarcadero Pesquero Artesanal de Supe, Distrito de Supe Puerto, Provincia de Barranca, Región Lima".
- Con Carta N° 1398-2018-FONDEPES-DIGENIPAA del 13.12.2018, el FONDEPES solicita a la supervisión, pronunciamiento de la viabilidad de la solución técnica del expediente del Adicional de Obra N° 06 y Deductivo Vinculado N° 05.





- Con Carta CSL174302.PU.230.18.DPA.S del 18.12.18, la supervisión, emite pronunciamiento de viabilidad de solución técnica del expediente del Adicional N° 06 y Deductivo Vinculado N° 05 del DPA Supe.
- Con Memorando N° 360-2018-FONDEPES/DIGENIPAA/AEP del 21.12.2018, el Área de Estudios y Proyectos, deriva el expediente del Adicional de Obra N° 06 y Deductivo Vinculado N° 05 al Área de Obra, Equipamiento y Mantenimiento.

III. MARCO LEGAL:

Generales:

- Ley N° 30225, Ley de Contrataciones del Estado modificada por Decreto Legislativo N° 1341 y su Reglamento, aprobado por D.S. N°:350-2015-EF y modificado por D.S. N° 056-2017, vigente desde el 17 de marzo del 2017.
- N° 025-2017-FONDEPES

Específicas:

- Artículo 34° de la Ley de Contrataciones del Estado establece respecto a los adicionales de obra:

34.1 *El contrato puede modificarse en los supuestos contemplados en la ley y el Reglamento, por orden de la Entidad o a solicitud del contratista, para alcanzar la finalidad del contrato de manera oportuna y eficiente. En este último caso la modificación debe ser aprobada por la Entidad. Dichas modificaciones no deben afectar el equilibrio económico financiero del contrato; en caso contrario, la parte beneficiada debe compensar económicamente a la parte perjudicada para restablecer dicho equilibrio, en atención al principio de equidad.*

34.3 *Tratándose de obras, las prestaciones adicionales pueden ser hasta por el 15% del monto total del contrato original, restándole los presupuestos deductivos vinculados. Para tal efecto, los pagos correspondientes son aprobados por el Titular de la Entidad.*
- Artículo 165° del Reglamento de la Ley de Contrataciones del Estado establece:

"Las consultas cuando por su naturaleza, en opinión del Inspector o supervisor, requieran de la opinión del proyectista son elevados por este a la Entidad dentro de cuatro (4) días siguientes de anotadas, correspondiendo a esta en coordinación con el proyectista absolver la consulta dentro del plazo máximo de quince (15) días siguientes de la comunicación del inspector o supervisor", y adicionalmente el mismo artículo en párrafo siguiente indica: "En caso no hubiere respuesta del proyectista en el plazo indicado en el párrafo anterior, la Entidad debe absolver la consulta y dar instrucciones al contratista a través del inspector o supervisor, sin perjuicio de las acciones que se adopten contra el proyectista, por la falta de absolución de la misma".
- Artículo 175° del Reglamento de la Ley de Contrataciones del Estado

El artículo 175° del RLCE, ítem 175.1, en cuanto a las prestaciones adicionales de obras menores al quince por ciento (15%), establece lo siguiente:

175.1 *Solo procede la ejecución de prestaciones adicionales de obra cuando previamente se cuente con la certificación de crédito presupuestario o previsión presupuestal y la resolución del Titular de la Entidad y en los casos en que sus montos, restándole los presupuestos deductivos vinculados, no excedan el quince por ciento (15%) del monto del contrato original. (El subrayado es agregado).*





175.2 La necesidad de ejecutar una prestación adicional de obra debe ser anotada en el cuaderno de obra, sea por el contratista a través de su residente, o por el Inspector o supervisor, según corresponda. En un plazo máximo de cinco (5) días contados a partir del día siguiente de realizada la anotación, el inspector o supervisor, según corresponda, debe comunicar a la Entidad la anotación realizada, adjuntando un informe técnico que sustente su posición respecto de la necesidad de ejecutar la prestación adicional. Además; se (...).

175.4 La Entidad debe definir si la elaboración del expediente técnico de la prestación adicional de obra está a su cargo, a cargo de un consultor externo o a cargo del inspector o supervisor, este último en calidad de prestación adicional, aprobada conforme al procedimiento previsto en el artículo 139. Para dicha definición, la Entidad debe tener en consideración la naturaleza, magnitud, complejidad, entre otros aspectos relevantes de la obra principal, así como la capacidad técnica y/o especialización del Inspector o supervisor, cuando considere encargarle a éste la elaboración del expediente técnico.

175.5 Concluida la elaboración del expediente técnico el Inspector o supervisor lo eleva a la Entidad.

En caso el expediente técnico lo elabore la Entidad o un consultor externo, el Inspector o supervisor cuenta con un plazo de cinco (5) días hábiles, contados a partir del día siguiente de la recepción del expediente técnico, para remitir a la Entidad el informe en el que se pronuncie sobre la viabilidad de la solución técnica planteada en el expediente técnico. En ambos casos, de existir partidas cuyos precios unitarios no están previstos en el presupuesto de obra, se adjunta al expediente técnico el documento del precio unitario pactado con el contratista ejecutor de la obra.

175.6 Recibida la comunicación del Inspector o supervisor, la Entidad cuenta con doce (12) días hábiles para emitir y notificar al contratista la resolución mediante la que se pronuncia sobre la procedencia de la ejecución de la prestación adicional de obra. La demora de la Entidad en emitir y notificar esta resolución, puede ser causal de ampliación de plazo.

175.9 En los contratos de obra a precios unitarios, los presupuestos adicionales de obra se formulan con los precios del contrato y/o precios pactados y los gastos generales fijos y variables propios de la prestación adicional para lo cual debe realizarse el análisis correspondiente teniendo como base o referencia el análisis de los gastos generales del presupuesto original contratado. Asimismo, debe incluirse la utilidad del presupuesto ofertado y el Impuesto General a las Ventas correspondiente.

175.12 De no existir precios unitarios de una determinada partida requerida en la prestación adicional, se pactarán nuevos precios unitarios, considerando los precios de los insumos, tarifas o jornales del presupuesto de obra y de no existir, se sustenta en precios del mercado debidamente sustentadas.

175.13 El pago de los presupuestos adicionales aprobados se realiza mediante valorizaciones adicionales.

175.14 Cuando se a prueba la prestación adicional de obra, el contratista está obligado a ampliar el monto de la garantía de fiel cumplimiento. Igualmente, cuando se apruebe la reducción de prestaciones, el contratista puede reducir el monto de dicha garantía.

175.15 Los adicionales, reducciones y los mayores o menores metrados que se produzcan



durante la ejecución de proyectos de inversión pública deben ser comunicados por la Entidad a la autoridad competente del Sistema Nacional de Inversión Pública.

**IV. MATERIA: JUSTIFICACION DEL ADICIONAL DE OBRA N° 06 Y DEDUCTIVO VINCULADO N° 05.
ANALISIS:**

- Durante el proceso de ejecución de la obra, el contratista Consorcio Marítimo del Norte, ha formulado vía cuaderno de Obra según: Asiento N° 20 del 22.09.2017, Asiento N° 353 del 09.06.2018, Asiento N° 397 del 14.08.2018, consultas y observaciones al proyecto respecto de la partida de MEDIA TENSION, específicamente por no contar con metrados, por la capacidad del transformador de la subestación que no cubriría la demanda instalada, falta de factibilidad y punto de diseño que otorga el Concesionario ENEL. Así como, por las incompatibilidades entre planos, especificaciones técnicas y memoria descriptiva, documentos que conforman el proyecto de la media tensión.
- Ante esto, con Carta N° 915-2018-FONDEPES/DIGENIPAA del 20 de agosto del 2018 e Informe N° 169-2017-FONDEPES-DIGENIPAA/LATH adjunto, se solicitó al representante legal Ing. Gonzalo F. Cáceres Valdivia del proyectista CONSORCIO SAN FRANCISCO, la absolución de consultas entre otras de la especialidad de instalaciones eléctricas de media tensión del DPA de Huacho; no obteniendo respuesta y existiendo plazos perentorios para dar atención a dichos documentos; se ha procedido como lo estipula el Artículo 165° del Reglamento de la Ley de Contrataciones del Estado.
- Ante la falta de respuesta del Proyectista y con el objetivo de alcanzar la finalidad del contrato al contar con un proyecto de Media Tensión confiable para la alimentación del servicio eléctrico en el DPA Supe y que esté de acuerdo a la demanda instalada requerida para el correcto funcionamiento del sistema eléctrico de las edificaciones, los equipos eléctricos y/o electromecánicos; se realizó una revisión de la potencia instalada y la demanda máxima, la cual evidenció deficiencias en los cálculos y la necesidad del rediseño; condicionado además por la falta de factibilidad y punto de diseño; esta situación obligo a realizar el trámite de solicitud de Factibilidad y Punto de Diseño ante el concesionario eléctrico ENEL y la elaboración por un tercero del expediente técnico del "Sistema de Utilización en Media Tensión 20 kV (Operación Inicial 10 kV)", de acuerdo con la disposición contenida en la norma R.D. N° 018-2002 EM/DGE "Norma de Procedimientos para la Elaboración de Proyectos y Ejecución de Obras en Sistemas de Distribución y Sistemas de Utilización en Media Tensión".
- Mediante Carta 1552831 del 12 de diciembre del 2018, la empresa concesionaria ENEL, otorga conformidad al expediente del proyecto del "Sistema de Utilización en Media Tensión 20 kV (Operación Inicial 10 kV)" del DPA de Supe, elaborado por el consultor Ing. Juan Cabezas Huamani, proyecto que modifica el expediente de media tensión.
- Con Memorando N° 360-2018-FONDEPES/DIGENIPAA/AEP del 21.12.2018, el Área de Estudios y Proyectos, deriva el expediente del Adicional de Obra N° 06 y Deductivo Vinculado N° 05 al Área de Obra, Equipamiento y Mantenimiento por la modificación de la media tensión.
- En conclusión, el Adicional de Obra N° 06 y deductivo Vinculado N° 05, se justifica para subsanar los errores, deficiencias y omisiones del expediente técnico en los planos, memoria descriptiva y cálculos justificativos de la especialidad de instalaciones eléctricas de la media tensión del DPA de Supe, por el cual se debe deslindar responsabilidades.

Página 6 de 14



V. COSTO DEL ADICIONAL DE OBRA N° 06 Y DEDUCTIVO VINCULADO N° 05 Y SU INCIDENCIA PRESUPUESTAL

5.1 Presupuesto del Adicional de Obra N° 06: Sistema de Utilización en Medía Tensión

		Presupuesto			
SISTEMA DE UTILIZACION EN 10 KV DPA SUPE					
FONDO NACIONAL DE DESARROLLO PESQUERO					
LINA - BARRANCA - SUPE PUERTO					
Item	Descripción	Unid.	Método	Presup. B.	Presup. P.
	INSTALACIONES ELECTRICAS				213,913.00
	CONDUCCION DE CABLES				6,018.00
	TRAYECTOS DE CABLES	m	100	2,700.00	2,700.00
	ELABORACION DE PLANOS DE ARRANQUE EN LA TOTALIDAD DEL TRAYECTO	ps	100	3,318.00	3,318.00
	ESTRUCTURA DE SISTEMA DE PROTECCION CON FIDUCIOS				12,240.00
	CONSTRUCCION DE TORRE PARA PROTECCION DE CABLES Y ACCESORIOS	un	100	2,500.00	2,500.00
	CONSTRUCCION DE TORRE PARA PROTECCION DE CABLES Y ACCESORIOS DE ALTA TENSION	un	100	2,400.00	2,400.00
	CONSTRUCCION DE TORRE PARA PROTECCION DE CABLES Y ACCESORIOS DE ALTA TENSION	un	100	2,200.00	2,200.00
	CONSTRUCCION DE TORRE PARA PROTECCION DE CABLES Y ACCESORIOS DE ALTA TENSION	un	100	2,100.00	2,100.00
	CONSTRUCCION DE TORRE PARA PROTECCION DE CABLES Y ACCESORIOS DE ALTA TENSION	un	100	2,000.00	2,000.00
	CONSTRUCCION DE TORRE PARA PROTECCION DE CABLES Y ACCESORIOS DE ALTA TENSION	un	100	1,900.00	1,900.00
	CONSTRUCCION DE TORRE PARA PROTECCION DE CABLES Y ACCESORIOS DE ALTA TENSION	un	100	1,800.00	1,800.00
	CONSTRUCCION DE TORRE PARA PROTECCION DE CABLES Y ACCESORIOS DE ALTA TENSION	un	100	1,700.00	1,700.00
	CONSTRUCCION DE TORRE PARA PROTECCION DE CABLES Y ACCESORIOS DE ALTA TENSION	un	100	1,600.00	1,600.00
	CONSTRUCCION DE TORRE PARA PROTECCION DE CABLES Y ACCESORIOS DE ALTA TENSION	un	100	1,500.00	1,500.00
	CONSTRUCCION DE TORRE PARA PROTECCION DE CABLES Y ACCESORIOS DE ALTA TENSION	un	100	1,400.00	1,400.00
	CONSTRUCCION DE TORRE PARA PROTECCION DE CABLES Y ACCESORIOS DE ALTA TENSION	un	100	1,300.00	1,300.00
	CONSTRUCCION DE TORRE PARA PROTECCION DE CABLES Y ACCESORIOS DE ALTA TENSION	un	100	1,200.00	1,200.00
	CONSTRUCCION DE TORRE PARA PROTECCION DE CABLES Y ACCESORIOS DE ALTA TENSION	un	100	1,100.00	1,100.00
	CONSTRUCCION DE TORRE PARA PROTECCION DE CABLES Y ACCESORIOS DE ALTA TENSION	un	100	1,000.00	1,000.00
	CONSTRUCCION DE TORRE PARA PROTECCION DE CABLES Y ACCESORIOS DE ALTA TENSION	un	100	900.00	900.00
	CONSTRUCCION DE TORRE PARA PROTECCION DE CABLES Y ACCESORIOS DE ALTA TENSION	un	100	800.00	800.00
	CONSTRUCCION DE TORRE PARA PROTECCION DE CABLES Y ACCESORIOS DE ALTA TENSION	un	100	700.00	700.00
	CONSTRUCCION DE TORRE PARA PROTECCION DE CABLES Y ACCESORIOS DE ALTA TENSION	un	100	600.00	600.00
	CONSTRUCCION DE TORRE PARA PROTECCION DE CABLES Y ACCESORIOS DE ALTA TENSION	un	100	500.00	500.00
	CONSTRUCCION DE TORRE PARA PROTECCION DE CABLES Y ACCESORIOS DE ALTA TENSION	un	100	400.00	400.00
	CONSTRUCCION DE TORRE PARA PROTECCION DE CABLES Y ACCESORIOS DE ALTA TENSION	un	100	300.00	300.00
	CONSTRUCCION DE TORRE PARA PROTECCION DE CABLES Y ACCESORIOS DE ALTA TENSION	un	100	200.00	200.00
	CONSTRUCCION DE TORRE PARA PROTECCION DE CABLES Y ACCESORIOS DE ALTA TENSION	un	100	100.00	100.00



[Signature]
ROSA GUILLIANA SANTOYO ROBLES
INGENIERA CIVIL
Reg. CIP N° 17725

[Signature]
LUIS ALBERTO TELLO HIDALGO
INGENIERO CIVIL
Reg. CIP N° 39250

"Decenio de la Igualdad de Oportunidades para Mujeres y Hombres"
"Año del Diálogo y la Reconciliación Nacional"

000064

100	PUESTA A FUEGA			0124.48
100.1	POLEA PARA TIRAR DE LA RED SUBESTACION EN BOYARDO	uds	1.00	1025.12
100.2	POLEA PARA TIRAR DE RED EN EL TRANSMISOR EN EL P.M. OYAY	uds	1.00	1025.12
100.3	POLEA PARA TIRAR EN LA CONSTRUCCION DE PROYECTOS PESQUEROS	uds	1.00	1025.12
100.4	POLEA PARA TIRAR EN PROYECTOS PESQUEROS	uds	1.00	1025.12
100.5	POLEA PARA TIRAR EN PROYECTOS PESQUEROS	uds	1.00	1025.12
100.6	POLEA PARA TIRAR EN PROYECTOS PESQUEROS	uds	1.00	1025.12
100.7	POLEA PARA TIRAR EN PROYECTOS PESQUEROS	uds	1.00	1025.12
100.8	POLEA PARA TIRAR EN PROYECTOS PESQUEROS	uds	1.00	1025.12
100.9	POLEA PARA TIRAR EN PROYECTOS PESQUEROS	uds	1.00	1025.12
100.10	POLEA PARA TIRAR EN PROYECTOS PESQUEROS	uds	1.00	1025.12
100.11	POLEA PARA TIRAR EN PROYECTOS PESQUEROS	uds	1.00	1025.12
100.12	POLEA PARA TIRAR EN PROYECTOS PESQUEROS	uds	1.00	1025.12
100.13	POLEA PARA TIRAR EN PROYECTOS PESQUEROS	uds	1.00	1025.12
100.14	POLEA PARA TIRAR EN PROYECTOS PESQUEROS	uds	1.00	1025.12
100.15	POLEA PARA TIRAR EN PROYECTOS PESQUEROS	uds	1.00	1025.12
100.16	POLEA PARA TIRAR EN PROYECTOS PESQUEROS	uds	1.00	1025.12
100.17	POLEA PARA TIRAR EN PROYECTOS PESQUEROS	uds	1.00	1025.12
100.18	POLEA PARA TIRAR EN PROYECTOS PESQUEROS	uds	1.00	1025.12
100.19	POLEA PARA TIRAR EN PROYECTOS PESQUEROS	uds	1.00	1025.12
100.20	POLEA PARA TIRAR EN PROYECTOS PESQUEROS	uds	1.00	1025.12
100.21	POLEA PARA TIRAR EN PROYECTOS PESQUEROS	uds	1.00	1025.12
100.22	POLEA PARA TIRAR EN PROYECTOS PESQUEROS	uds	1.00	1025.12
100.23	POLEA PARA TIRAR EN PROYECTOS PESQUEROS	uds	1.00	1025.12
100.24	POLEA PARA TIRAR EN PROYECTOS PESQUEROS	uds	1.00	1025.12
100.25	POLEA PARA TIRAR EN PROYECTOS PESQUEROS	uds	1.00	1025.12
100.26	POLEA PARA TIRAR EN PROYECTOS PESQUEROS	uds	1.00	1025.12
100.27	POLEA PARA TIRAR EN PROYECTOS PESQUEROS	uds	1.00	1025.12
100.28	POLEA PARA TIRAR EN PROYECTOS PESQUEROS	uds	1.00	1025.12
100.29	POLEA PARA TIRAR EN PROYECTOS PESQUEROS	uds	1.00	1025.12
100.30	POLEA PARA TIRAR EN PROYECTOS PESQUEROS	uds	1.00	1025.12
100.31	POLEA PARA TIRAR EN PROYECTOS PESQUEROS	uds	1.00	1025.12
100.32	POLEA PARA TIRAR EN PROYECTOS PESQUEROS	uds	1.00	1025.12
100.33	POLEA PARA TIRAR EN PROYECTOS PESQUEROS	uds	1.00	1025.12
100.34	POLEA PARA TIRAR EN PROYECTOS PESQUEROS	uds	1.00	1025.12
100.35	POLEA PARA TIRAR EN PROYECTOS PESQUEROS	uds	1.00	1025.12
100.36	POLEA PARA TIRAR EN PROYECTOS PESQUEROS	uds	1.00	1025.12
100.37	POLEA PARA TIRAR EN PROYECTOS PESQUEROS	uds	1.00	1025.12
100.38	POLEA PARA TIRAR EN PROYECTOS PESQUEROS	uds	1.00	1025.12
100.39	POLEA PARA TIRAR EN PROYECTOS PESQUEROS	uds	1.00	1025.12
100.40	POLEA PARA TIRAR EN PROYECTOS PESQUEROS	uds	1.00	1025.12
100.41	POLEA PARA TIRAR EN PROYECTOS PESQUEROS	uds	1.00	1025.12
100.42	POLEA PARA TIRAR EN PROYECTOS PESQUEROS	uds	1.00	1025.12
100.43	POLEA PARA TIRAR EN PROYECTOS PESQUEROS	uds	1.00	1025.12
100.44	POLEA PARA TIRAR EN PROYECTOS PESQUEROS	uds	1.00	1025.12
100.45	POLEA PARA TIRAR EN PROYECTOS PESQUEROS	uds	1.00	1025.12
100.46	POLEA PARA TIRAR EN PROYECTOS PESQUEROS	uds	1.00	1025.12
100.47	POLEA PARA TIRAR EN PROYECTOS PESQUEROS	uds	1.00	1025.12
100.48	POLEA PARA TIRAR EN PROYECTOS PESQUEROS	uds	1.00	1025.12
100.49	POLEA PARA TIRAR EN PROYECTOS PESQUEROS	uds	1.00	1025.12
100.50	POLEA PARA TIRAR EN PROYECTOS PESQUEROS	uds	1.00	1025.12
100.51	POLEA PARA TIRAR EN PROYECTOS PESQUEROS	uds	1.00	1025.12
100.52	POLEA PARA TIRAR EN PROYECTOS PESQUEROS	uds	1.00	1025.12
100.53	POLEA PARA TIRAR EN PROYECTOS PESQUEROS	uds	1.00	1025.12
100.54	POLEA PARA TIRAR EN PROYECTOS PESQUEROS	uds	1.00	1025.12
100.55	POLEA PARA TIRAR EN PROYECTOS PESQUEROS	uds	1.00	1025.12
100.56	POLEA PARA TIRAR EN PROYECTOS PESQUEROS	uds	1.00	1025.12
100.57	POLEA PARA TIRAR EN PROYECTOS PESQUEROS	uds	1.00	1025.12
100.58	POLEA PARA TIRAR EN PROYECTOS PESQUEROS	uds	1.00	1025.12
100.59	POLEA PARA TIRAR EN PROYECTOS PESQUEROS	uds	1.00	1025.12
100.60	POLEA PARA TIRAR EN PROYECTOS PESQUEROS	uds	1.00	1025.12
100.61	POLEA PARA TIRAR EN PROYECTOS PESQUEROS	uds	1.00	1025.12
100.62	POLEA PARA TIRAR EN PROYECTOS PESQUEROS	uds	1.00	1025.12
100.63	POLEA PARA TIRAR EN PROYECTOS PESQUEROS	uds	1.00	1025.12
100.64	POLEA PARA TIRAR EN PROYECTOS PESQUEROS	uds	1.00	1025.12
100.65	POLEA PARA TIRAR EN PROYECTOS PESQUEROS	uds	1.00	1025.12
100.66	POLEA PARA TIRAR EN PROYECTOS PESQUEROS	uds	1.00	1025.12
100.67	POLEA PARA TIRAR EN PROYECTOS PESQUEROS	uds	1.00	1025.12
100.68	POLEA PARA TIRAR EN PROYECTOS PESQUEROS	uds	1.00	1025.12
100.69	POLEA PARA TIRAR EN PROYECTOS PESQUEROS	uds	1.00	1025.12
100.70	POLEA PARA TIRAR EN PROYECTOS PESQUEROS	uds	1.00	1025.12
100.71	POLEA PARA TIRAR EN PROYECTOS PESQUEROS	uds	1.00	1025.12
100.72	POLEA PARA TIRAR EN PROYECTOS PESQUEROS	uds	1.00	1025.12
100.73	POLEA PARA TIRAR EN PROYECTOS PESQUEROS	uds	1.00	1025.12
100.74	POLEA PARA TIRAR EN PROYECTOS PESQUEROS	uds	1.00	1025.12
100.75	POLEA PARA TIRAR EN PROYECTOS PESQUEROS	uds	1.00	1025.12
100.76	POLEA PARA TIRAR EN PROYECTOS PESQUEROS	uds	1.00	1025.12
100.77	POLEA PARA TIRAR EN PROYECTOS PESQUEROS	uds	1.00	1025.12
100.78	POLEA PARA TIRAR EN PROYECTOS PESQUEROS	uds	1.00	1025.12
100.79	POLEA PARA TIRAR EN PROYECTOS PESQUEROS	uds	1.00	1025.12
100.80	POLEA PARA TIRAR EN PROYECTOS PESQUEROS	uds	1.00	1025.12
100.81	POLEA PARA TIRAR EN PROYECTOS PESQUEROS	uds	1.00	1025.12
100.82	POLEA PARA TIRAR EN PROYECTOS PESQUEROS	uds	1.00	1025.12
100.83	POLEA PARA TIRAR EN PROYECTOS PESQUEROS	uds	1.00	1025.12
100.84	POLEA PARA TIRAR EN PROYECTOS PESQUEROS	uds	1.00	1025.12
100.85	POLEA PARA TIRAR EN PROYECTOS PESQUEROS	uds	1.00	1025.12
100.86	POLEA PARA TIRAR EN PROYECTOS PESQUEROS	uds	1.00	1025.12
100.87	POLEA PARA TIRAR EN PROYECTOS PESQUEROS	uds	1.00	1025.12
100.88	POLEA PARA TIRAR EN PROYECTOS PESQUEROS	uds	1.00	1025.12
100.89	POLEA PARA TIRAR EN PROYECTOS PESQUEROS	uds	1.00	1025.12
100.90	POLEA PARA TIRAR EN PROYECTOS PESQUEROS	uds	1.00	1025.12
100.91	POLEA PARA TIRAR EN PROYECTOS PESQUEROS	uds	1.00	1025.12
100.92	POLEA PARA TIRAR EN PROYECTOS PESQUEROS	uds	1.00	1025.12
100.93	POLEA PARA TIRAR EN PROYECTOS PESQUEROS	uds	1.00	1025.12
100.94	POLEA PARA TIRAR EN PROYECTOS PESQUEROS	uds	1.00	1025.12
100.95	POLEA PARA TIRAR EN PROYECTOS PESQUEROS	uds	1.00	1025.12
100.96	POLEA PARA TIRAR EN PROYECTOS PESQUEROS	uds	1.00	1025.12
100.97	POLEA PARA TIRAR EN PROYECTOS PESQUEROS	uds	1.00	1025.12
100.98	POLEA PARA TIRAR EN PROYECTOS PESQUEROS	uds	1.00	1025.12
100.99	POLEA PARA TIRAR EN PROYECTOS PESQUEROS	uds	1.00	1025.12
100.100	POLEA PARA TIRAR EN PROYECTOS PESQUEROS	uds	1.00	1025.12
	COSTO DIRECTO			280248.21
	GASTOS GENERALES PROYECTOS			42310.31
	EFICIENCIA Y DESPERDIO			6.400.00
	SUB TOTAL			329158.52
	10% 1857%			31058.15
	TOTAL PRESUPUESTO			360216.67



[Signature]
ROSA JULIANA BANTOYO ROBLES
INGENIERA CIVIL
Reg. CIP N° 109208



[Signature]
LUIS ALBERTO TELLO HIDALGO
INGENIERO CIVIL
Reg. CIP N° 39250



"Decenio de la Igualdad de Oportunidades para Mujeres y Hombres"
"Año del Diálogo y la Reconciliación Nacional"

000003

5.2 Presupuesto Deductivo Vinculado N° 05: Sistema de Utilización en Media Tensión



Presupuesto Deductivo Vinculante

Título: OBRAS DE MEJORA DE LOS SERVICIOS DEL DISTRITO PESQUERO ARTESANAL DE SUPE
 Subtítulo: INSTALACIONES ELECTRICAS MEDIA TENSION
 Unidad Ejecutora: FONDO NACIONAL DE DESARROLLO PESQUERO
 Lugar: LIMA - BARRANCA - SUPE PUERTO

Código	Descripción	Unid.	Cantidad	Presup. El.	Presup. B.
3102	MEDIA TENSION				215,193.48
310201	OBRAS PRELIMINARES				3,482.34
31020101	PROTECCION DE PERFORACIONES	UD	100	3,482.34	3,482.34
310202	MOVIMIENTO DE TIERRAS				1,291.00
31020201	TRASPASE, CARGO, CARGO DE OBRAS EN TERRENO NATURAL	m3	800	1,291.00	1,291.00
31020202	TRASPASE, CARGO, CARGO DE OBRAS EN TERRENO NATURAL	m2	400	200.00	200.00
310203	CONDUCTOS Y CANALIZACIONES				3,494.88
31020301	CONDUCTOS DE 1/2" A 1" Y MAS EN TERRENO NATURAL	m2	800	1,291.00	1,291.00
31020302	CONDUCTOS DE 1/2" A 1" Y MAS EN TERRENO NATURAL	m2	200	200.00	200.00
31020303	TIERRA COMPACTADA CEMENTADA 4" PARA CABLES ELECTRICOS	m	800	1,291.00	1,291.00
31020304	TIERRA COMPACTADA ELECTRICAMENTE	m	100	200.00	200.00
310204	MONTAJE DE POSTES DE CONCRETO				1,875.00
31020401	MONTAJE DE POSTES DE CONCRETO PARA POSTES	UD	100	1,875.00	1,875.00
310205	MONTAJE DE C.A.C. (CABLES)	m	100	1,875.00	1,875.00
310206	MONTAJE DE C.A.C. (CABLES)	m	100	1,875.00	1,875.00
310207	MONTAJE DE ARMADOS				14,914.00
31020701	ARMADO DE CIMENTACION	UD	100	1,875.00	1,875.00
31020702	ARMADO DE TRAMATA	m	100	13,039.00	13,039.00
310208	MONTAJE DE CONDUCTORES				3,419.48
31020801	TRABAJO DE CABLEADO DE CONDUCTORES ARMADOS	m	3000	2,112.00	2,112.00
31020802	TRABAJO DE CABLEADO DE CONDUCTORES ARMADOS EN LAS BARRAS DE SUPE	m	3000	597.48	597.48
310209	ACCESORIOS PARA CONECTOR DE CORTA MANS Y DE 35-40	UD	200	1,710.00	1,710.00
310210	INSTALACION DE PUERTA A TIERRA				2,531.24
31021001	EXCAVACION DE BUECO PARA PUERTA A TIERRA EN TERRENO NATURAL	m3	400	2,531.24	2,531.24
310211	TRABAJO DE CIMENTACION A TIERRA TODA LA L	m2	400	1,811.00	1,811.00
310212	TRABAJO DE CIMENTACION CON PUERTA A TIERRA	m2	400	200.00	200.00

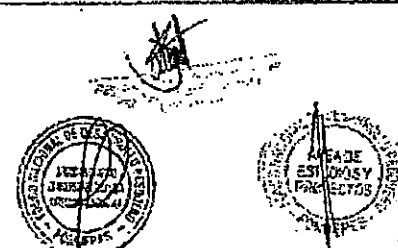

ROSA GUILIANA SANTOYO ROBLES
INGENIERA CIVIL
Reg. CIP N° 109706

LUIS ALBERTO TELLO HIDALGO
INGENIERO CIVIL
Reg. CIP N° 39250

"Decenio de la Igualdad de Oportunidades para Mujeres y Hombres"
"Año del Diálogo y la Reconciliación Nacional"

000.02

Código	Descripción	Unidad	Cantidad	Valor Unitario	Valor Total
04 02 00	INSTALACION DE SUBESTACION ELECTRICA				150,288.42
04 02 01	SELECCION LUGAR Y RESERVA DE TIERRA PARA LA SUBESTACION	UND	1.00	55,267.76	55,267.76
04 02 02	ELABORACION DE PROYECTO DE EQUIPAMIENTO	UND	1.00	38,226.60	38,226.60
04 02 03	MONTEO DE CABLES PARA TRANSFORMADOR DE 150 KVA	UND	1.00	78,677.06	78,677.06
04 02 04	TRABAJOS DE CABLEADO Y MONTAJE DE TRANSFORMADOR	UND	1.00	8,117.00	8,117.00
04 02 05	PROTECCION DE CONEXIONES NEGATIVAS	UND	1.00	10,298.00	10,298.00
04 02 00	INSTALACION DE SISTEMA DE DETECCION				2,086.28
04 02 01	SELECCION DE TIPO DE DETECTOR DE FUGA A TIERRA	UND	1.00	1,177.24	1,177.24
04 02 02	SELECCION DE CABLES PARA LOS DETECTORES	UND	1.00	1,885.94	1,885.94
04 02 00	PROBES Y PUESTAS EN SERVIDIO				2,017.42
04 02 01	PROBES Y PUESTAS EN SERVIDIO DE RED PRIMARIA Y SUBESTACION	UND	2.00	1,008.71	2,017.42
04 02 02	CONEXION ELECTRICA	UND	1.00	1,008.71	1,008.71
	COSTO DIRECTO				152,380.48
	GASTOS GENERALES ADMINISTRATIVOS				47,288.05
	IMPORTE ESTIMADO				199,668.53
	SUBTOTAL				242,870.28
	T.O.M. (10%)				24,287.03
	TOTAL PRESUPUESTO				267,157.31

[Handwritten signature]

[Handwritten signature]
ROSA GUILIANA SANTOYO ROBLES
INGENIERA CIVIL
Reg. CIP N° 109706



121

Nota: El Presupuesto es parte del Expediente del presente adicional, elaborado por el Área de Estudios y Proyectos y trasladada al Área de Obra, Equipamiento y Mantenimiento con Memorando N° 360-2018_FONDEPES/DIGENIPAA/AEP del 21.12.2018 e Informe N° 052-2018-FONDEPES/DIGENIPAA/AEP/CMRV del 21.12.2018 para el trámite de aprobación.

[Handwritten signature]
LUIS ALBERTO TELLO HIDALGO
INGENIERO CIVIL
Reg. CIP N° 39250

"Decenio de la Igualdad de Oportunidades para Mujeres y Hombres"
"Año del Diálogo y la Reconciliación Nacional"

000261

5.3 Acta de Pactación de Precios



ACTA DE PRECIOS UNITARIOS FACTADOS

Contrato N° 025-2017-FONDEPES

En la ciudad de Lima, siendo las 12:00 horas del día 20 de diciembre del 2018, se reunieron las siguientes personas:

Ing. Luis Alberto Tello Hidalgo Director General DIGENIPAA-FONDEPES
Sr. Roberto Carlos Alvarez Loyola Representante Legal, CONSORCIO MARITIMO DEL NORTE

Quienes después de un largo debate técnico e intercambio de opiniones, decidieron postar los nuevos precios unitarios que se generan como producto de las nuevas actividades, necesarias para alcanzar las metas de la obra "Mejoramiento y recuperación de los Servicios del Desembarcadero Pesquero Artesanal de Supe, Distrito de Supe Puerto, Provincia de Barranca, Región Lima", de acuerdo al siguiente detalle, los mismos formarán parte del presupuesto de la valoración económica de la prestación del adicional de obra N° 06:

Item	Descripción	Und.	Precio \$/l.
01	INSTALACIONES ELECTRICAS		
01.01	TRABAJOS PRELIMINARES		
01.01.01	TRANSPORTE DE MATERIALES	ml	2,829.60
01.01.02	ELABORACION DE PLAN DE SEGURIDAD EN EL TRABAJO ELECTRICO	gd	3,268.24
01.02	ESTRUCTURA DE SISTEMA DE PROTECCION CON RECLOSER		
01.02.01	SUMINISTRO E INSTALACION DE POSTE C.A.C. 15400210435 Y ACCESORIOS	und	2,688.19
01.02.02	SUMINISTRO E INSTALACION DE FERRETERIA ELECTRICA (PRIMARIO DE ESTRUCTURA DE PROTECCION)	und	2,419.37



Adicional de Obra N° 06 y del deductivo vinculante N° 05
Obra: "MEJORAMIENTO Y RECUPERACION DE LOS SERVICIOS DEL DESEMBARCADERO PESQUERO ARTESANAL DE SUPE, DISTRITO DE SUPE PUERTO, PROVINCIA DE BARRANCA, REGION LIMA"



CONSORCIO MARITIMO DEL NORTE
Roberto Carlos Alvarez Loyola
Representante Legal



LUIS ALBERTO TELLO HIDALGO
INGENIERO CIVIL
Reg. CIP N° 39250



"Decenio de la Igualdad de Oportunidades para Mujeres y Hombres"
"Año del Diálogo y la Reconciliación Nacional"

000260

5.4 Detalle de la vinculación del Presupuesto Adicional N° 06 con consultas en Cuaderno de Obra e Informes.

DETALLE DE LA VINCULACION DEL PRESUPUESTO ADICIONAL N°06 CON LAS CONSULTAS DE OBRA

DESCRIPCIÓN	VÍNCULO O ANTECEDENTE
01 INSTALACIONES ELÉCTRICAS	
0101 TRABAJOS PRELIMINARES	ASIENTO N°20 DEL CUADERNO DE OBRA DEL 22.09.2017 DEL CONTRATISTA.
0102 ESTRUCTURA DE SISTEMA DE PROTECCIÓN CON RECLOSER	
0103 RED AEREA EN 10 KV	ASIENTO N°353 DEL CUADERNO DE OBRA DEL 09.06.2018 DEL CONTRATISTA.
0104 RED SUBTERRÁNEA	
0105 BUZONES	
0106 CABLES Y CONDUCTORES	ASIENTO N°397 DEL CUADERNO DE OBRA DEL 14.08.2018 DEL CONTRATISTA.
0107 TERMINALES TERMOCONTRAIBLES	
0108 EQUIPAMIENTO DE SUBESTACIÓN	
0109 PUESTA A TIERRA	CARTA CSL-174302-PU-DPA-S.72.8 DEL 15.08.2018 DE LA SUPERVISIÓN.
0110 SEÑALIZACIÓN	
0111 EQUIPOS DE PROTECCIÓN Y MANIOBRAS	INFORME CSL-174302-PU-ESP.28.8 DEL 16.08.2018 DE LA SUPERVISIÓN.
0112 PRUEBAS ELÉCTRICAS Y PUESTA EN SERVICIO	
0113 VARIOS	

5.5 Detalle de la vinculación del Presupuesto Adicional N° 06 y Deductivo Vinculado N° 05.

VINCULACION DEL PRESUPUESTO ADICIONAL N°06 Y DEDUCTIVO VINCULANTE N°05

INSTALACIONES ELÉCTRICAS DE MEDIA TENSION

ADICIONAL N°06		DEDUCTIVO N°05
01 INSTALACIONES ELÉCTRICAS MEDIA TENSION	04.02	MEDIA TENSION
01.01 TRABAJOS PRELIMINARES	04.02.01	OBRAS PRELIMINARES
01.02 ESTRUCTURA DE SISTEMA DE PROTECCIÓN CON RECLOSER	04.02.02	MOVIMIENTO DE TIERRAS
01.03 RED AEREA EN 10 KV	04.02.03	CONDUCTOS Y CANALIZACIONES
01.04 RED SUBTERRÁNEA	04.02.04	MONTAJE DE POSTES DE CONCRETO
01.05 BUZONES	04.02.05	MONTAJE DE ARMADOS
01.06 CABLES Y CONDUCTORES	04.02.06	MONTAJE DE CONDUCTORES
01.07 TERMINALES TERMOCONTRAIBLES	04.02.07	INSTALACION DE PUESTA A TIERRA
01.08 EQUIPAMIENTO DE SUBESTACION	04.02.08	INSTALACION DE SUBESTACION ELECTRICA
01.09 PUESTA A TIERRA	04.02.09	INSTALACION DE SISTEMA DE MEDICION
01.10 SEÑALIZACIÓN	04.02.10	PRUEBAS Y PUESTA EN SERVICIO
01.11 EQUIPOS DE PROTECCION Y MANIOBRAS		
01.12 PRUEBAS ELÉCTRICAS Y PUESTA EN SERVICIO		
01.13 VARIOS		



Nota: Cabe señalar que se ha verificado por parte de la DIGENIPAA que los informes y documentos señalados en los cuadros precedentes corroboran la efectiva vinculación entre el Presupuesto Adicional de Obra N° 06 y el Deductivo Vinculado N° 05 del expediente de Media Tensión en cada una de las partidas respectivas.





5.6 Monto e Incidencia del Adicional de Obra N° 06

DESCRIPCION	MONTOS	INDICENCIA
MONTO CONTRATADO	21'509,091.48	100.00%
ADICIONAL DE OBRA N° 06 (MEDIA TENSION)	340,246.17	1.58 %

5.7 Montos e Incidencia Acumulada de los Adicionales de Obra

DESCRIPCION	MONTOS	INDICENCIA
MONTO CONTRATADO	21'509,091.48	
ADICIONAL DE OBRA N° 01 (ENROCADO PROTECCION)	2'213,942.02	10.29%
DEDUCTIVO VINCULADO N° 01	-1'879,271.36	-8.74%
ADICIONAL DE OBRA N° 02	160,884.74	0.75 %
ADICIONAL DE OBRA N° 03 (II.EE.)	676,072.37	3.14 %
DEDUCTIVO VINCULADO N° 02	-242,870.31	-1.13%
ADICIONAL DE OBRA N°04 (II.SS.)	417,954.90	1.94 %
DEDUCTIVO VINCULADO N° 03	-220,209.97	-1.02%
ADICIONAL DE OBRA N°05 (OBRAS MENORES)	562,775.06	2.62 %
DEDUCTIVO VINCULADO N° 04	-187,675.96	-0.87%
ADICIONAL DE OBRA N°06 (MEDIA TENSION)	340,246.17	1.58 %
DEDUCTIVO VINCULADO N° 05	-339,697.56	-1.58%
TOTAL	1'502,150.10	6.98 %

MONTO VIGENTE	23'011,241.58	106.98 %
----------------------	----------------------	-----------------

VI. CONCLUSIONES

- ✓ Se ha cumplido con el procedimiento para el trámite de adicionales de obra, en concordancia con el artículo 175° del Reglamento de la Ley de Contrataciones del Estado.
- ✓ El Adicional de Obra N° 06 y Deductivo Vinculado N° 05, se ha generado por omisiones del expediente técnico en los Metrados, Memoria de Calculo y Planos de las instalaciones eléctricas de la Media Tensión, por el cual se debe deslindar responsabilidad del proyectista.
- ✓ Mediante Carta 1552831 del 12 de diciembre del 2018, la empresa concesionaria ENEL, otorga conformidad al expediente del proyecto del "Sistema de Utilización en Media Tensión 20 kV (Operación Inicial 10 kV)" del DPA de Supe, lo que genera el Adicional de Obra N° 06 y su respectivo deductivo vinculado.
- ✓ Con Carta CSL.174302.PU.230.18.DPA.S del 18.12.18, la supervisión, emite pronunciamiento de viabilidad de solución técnica del expediente del Adicional N° 06 y Deductivo Vinculado N° 05 del DPA Supe.
- ✓ Con Memorando N° 634-218-FONDEPES/OGPP del 27.12.2018, se otorga la Certificación de Crédito Presupuestario N° 4769 por un monto de **S/. 548.61** para el Adicional de Obra N° 06, en cumplimiento del ítem 175.1 del artículo 175° del Reglamento de la Ley de Contrataciones del Estado.
- ✓ El monto adicional y la incidencia respecto al monto contratado del **Adicional de obra N° 06** del

Página 13 de 14





proyecto: "MEJORAMIENTO Y RECUPERACION DE LOS SERVICIOS DEL DESEMBARCADERO PESQUERO ARTESANAL DE SUPE, DISTRITO DE SUPE PUERTO, PROVINCIA DE BARRANCA, REGION LIMA", es de S/. 340,246.17, monto que incluye el IGV y que representa el 1.58% del contrato de la obra y el **Deductivo Vinculado N° 05** por un monto de S/. 339,697.56, monto que incluye el IGV y que representa el 1.58% del contrato.

- ✓ Es preciso señalar, que la valoración económica del Adicional N° 06 y el respectivo deductivo vinculado, ha sido determinada por el Área de Estudios y Proyectos, no siendo competencia del suscrito emitir opinión sobre aspectos relacionados a la valoración presupuestal o económica del mencionado adicional y su deductivo vinculado.
- ✓ El monto acumulado de los adicionales aprobados y considerando el Adicional de Obra N° 06 y Deductivo Vinculado N° 05, es de S/. 1'502,150.10 que representa el 6.98% del monto del contrato de obra, monto y porcentaje que no requiere aprobación de la Contraloría. En consecuencia, el nuevo monto vigente será de S/. 23'011,241.58.

VII. RECOMENDACIONES

- ✓ Por lo expuesto, por ser necesario para alcanzar la finalidad del contrato en la ejecución del proyecto PIP N° 182813: "MEJORAMIENTO Y RECUPERACION DE LOS SERVICIOS DEL DESEMBARCADERO PESQUERO ARTESANAL DE SUPE, DISTRITO DE SUPE PUERTO, PROVINCIA DE BARRANCA, REGION LIMA", se recomienda el trámite de aprobación del **Adicional de obra N° 06**, por un monto de S/. 340,246.17, monto que incluye el IGV y que representa el 1.58% del contrato y el **Deductivo Vinculado N° 05** por un monto de S/. 339,697.56, monto que incluye el IGV y que representa el 1.58% del contrato de obra.
- ✓ Se recomienda comunicar al Sistema de Inversión Pública la modificación por la aprobación del Adicional de Obra N° 06 y Deductivo Vinculado N° 05 del DPA de Supe.
- ✓ Finalmente, se recomienda remitir notificación al contratista CONSORCIO MARITIMO DEL NORTE, con copia a la supervisión CESEL SA en una fecha no mayor al 30.12.2018.

Es cuanto informo a Usted para su conocimiento y fines.

Ing. Luis Alberto Tello Hidalgo.
CIP N° 39250

El coordinador del Área de Obras que suscribe hace suyo el documento.

FONDEPES
[Handwritten Signature]
Ing. RAFAELA MORA GUILER
COORDINADOR DE OBRAS PÚBLICAS



CONSORCIO MARITIMO DEL NORTE

CONSORCIO MARÍTIMO DEL NORTE

MEJORAMIENTO Y RECUPERACION DE LOS SERVICIOS DEL
DESEMBARCADERO PESQUERO ARTESANAL DE SUPE, DISTRITO DE SUPE
PUERTO, PROVINCIA DE BARRANCA, REGIÓN LIMA

Tipo de Documento	N°	Mes	Fecha
Valorización	18	Febrero	28/02/2019

000257

RESOLUCION AMPLIACION DE PLAZO N 14



"Decenio de la Igualdad de Oportunidades para Mujeres y Hombres"
 "Año del Diálogo y la Reconciliación Nacional"

Lima, 21 ENE. 2019

NOTARIA HOPKINS
 Av. Rosales 515 (Av. N. J. de la C. de Panamá)
 Telf.: 2404066 - 2709546 - 3938347
 www.notariahopkins.com

CARTA N° 030 -2019-FONDEPES/GG

Señores
CONSORCIO MARÍTIMO DEL NORTE
 Jr. Vizcaya N° 187, Urbanización Javier Prado
SAN LUIS.-

ESTE DOCUMENTO NO HA SIDO
 REDACTADO EN ESTA NOTARIA
 Carta Notarial N° 266
 Fecha 21 ENE 2019

Asunto : Aprobar la Ampliación de Plazo n.° 14, solicitada por el Contralista Consorcio Marítimo del Norte – Contrato n.° 025-2017-FONDEPES - para la Ejecución de la Obra: «Mejoramiento y recuperación de los Servicios del DPA de Supe, distrito de Supe Puerto, provincia de Barranca, Región Lima». Código SNIP.: 182813.

Ref. : Resolución de Gerencia General n.° 013-2019-FONDEPES/GG.

De mi consideración:

Tengo a bien dirigirme a ustedes, para saludarlos cordialmente y hacer de su conocimiento que el Fondo Nacional de Desarrollo Pesquero – FONDEPES, ha emitido la Resolución de la referencia, la misma que se adjunta para conocimiento y fines.

Atentamente,

FONDO NACIONAL DE DESARROLLO PESQUERO
FONDEPES

 KARLA ELIZABETH ESPINOZA MALAFESTA
 GERENCIA GENERAL

Se adjunta: Resolución de Gerencia General n.° 013-2019-FONDEPES/GG.
 Memorando n.° 108-2019-FONDEPES/DIGENIPAA.
 Informe n.° 05-2019-FONDEPES-DIGENIPAA/AOEM/LATH.
 Informe n.° 023-2019-FONDEPES/OGAJ.

CONSORCIO MARÍTIMO
 DEL NORTE
 21 ENE. 2019
RECIBIDO

c.c.: J / OGAJ / DIGENIPAA / OGA

KEEM/bpl

REPÚBLICA DEL PERÚ



RESOLUCIÓN DE GERENCIA GENERAL
N° 013-2019-FONDEPES/GG

Lima, 21 ENE. 2019

VISTOS: El Memorando n.º 108-2019-FONDEPES/DIGENIPAA y el Informe n.º 05-2019-FONDEPES-DIGENIPAA/AOEM/LATH, ambos de la Dirección General de Inversión Pesquera Artesanal y Acuicultura (en adelante, la Digenipaa), así como el Informe n.º 023-2019-FONDEPES/OGAJ de la Oficina General de Asesoría Jurídica (en adelante, la OGAJ); y

CONSIDERANDO:

Que, el 22 de agosto de 2017 el Fondo Nacional de Desarrollo Pesquero (en adelante, Fondapes) y el Consorcio Marítimo del Norte (en adelante, el Contratista), integrado por las empresas CEFOISA INGENIERÍA Y CONSTRUCCIÓN S.A.C., PCD S.A.C. y ASPHALT TECHNOLOGIES S.A.C., suscribieron el Contrato n.º 025-2017-FONDEPES, para la ejecución de la obra: «Mejoramiento y recuperación de los servicios del Desembarcadero Pesquero Artesanal de Supe, distrito de Supe Puerto, provincia de Barranca, región Lima» con Código SNIP n.º 182813 (en adelante, la Obra), por un monto de S/ 21 509 091,48 (Veintún millones quinientos nueve mil noventa y uno con 48/100 Soles), incluido IGV, y por un plazo de 270 días calendario;



Que, el 15 de setiembre de 2017 el Fondapes y la empresa CESEL S.A. (en adelante, el Supervisor) suscribieron el Contrato n.º 030-2017-FONDEPES para la supervisión de la Obra, por un plazo de 270 días calendario.



Que, el acto administrativo puede fundamentarse en informes de emisión previa que obren en el expediente correspondiente, a condición de su puntual identificación y su integración en el acto administrativo que motivan. Sobre el particular, en el numeral 6.2 del artículo 6 del Texto Único Ordenado de la Ley n.º 27444, Ley del Procedimiento Administrativo General, aprobado por el Decreto Supremo n.º 006-2017-JUS, se establece lo siguiente:

«Artículo 6.- Motivación del acto administrativo

(...)

6.2 Puede motivarse mediante la declaración de conformidad con los fundamentos y conclusiones de anteriores dictámenes, decisiones o informes obrantes en el expediente, a condición de que se les identifique de modo certero, y que por esta situación constituyan parte integrante del respectivo acto. (...).»;



Conforme a la normativa indicada sobre el contenido motivacional, constituyen fundamentos de la presente Resolución: el Memorando n.º 108-2019-FONDEPES/DIGENIPAA, el Informe n.º 05-2019-FONDEPES-DIGENIPAA/AOEM/LATH y el Informe n.º 023-2019-FONDEPES/OGAJ, los mismos que formarán parte integrante de la presente Resolución en calidad de anexos;

Por los fundamentos técnicos y normativos expuestos y de conformidad con la Ley n.º 30225, Ley de Contrataciones del Estado, modificada mediante Decreto Legislativo n.º 1341, y su Reglamento aprobado por Decreto Supremo n.º 350-2015-EF y modificado mediante Decreto Supremo n.º 056-2017-EF; y en ejercicio de las funciones establecidas por el literal «k» del artículo 10 del Reglamento de Organización y Funciones del Fondapes, aprobado por Resolución

Ministerial n.º 346-2012-PRODUCE, y en mérito de la facultad delegada en el literal e) del artículo 1 de la Resolución Jefatural n.º 069-2016-FONDEPES/J, corresponde expedir la Resolución de Gerencia General a través de la cual se apruebe la solicitud de Ampliación de Plazo n.º 14 solicitada por el Contratista;

Con los visados de la Dirección General de Inversión Pesquera Artesanal y Acuícola y de la Oficina General de Asesoría Jurídica, en lo que corresponde a sus respectivas competencias;

SE RESUELVE:

Artículo 1º.- Aprobar la Ampliación de Plazo n.º 14 solicitada por el Contratista, Consorcio Marítimo del Norte, en el marco del Contrato n.º 025-2017-FONDEPES, para la ejecución de la obra: «Mejoramiento y recuperación de los servicios del Desembarcadero Pesquero Artesanal de Supe, distrito de Supe Puerto, provincia de Barranca, región Lima» con Código SNIP n.º 182813, por el plazo de 75 días calendario, estableciéndose en consecuencia, como fecha final de la ejecución de la Obra el 15 de marzo de 2019, conforme a lo expuesto en el Memorando n.º 108-2019-FONDEPES/DIGENIPAA, el Informe n.º 05-2019-FONDEPES-DIGENIPAA/AOEM/LATH y el Informe n.º 023-2019-FONDEPES/OGAJ.

Artículo 2º.- Disponer que Contratista, Consorcio Marítimo del Norte, amplie el plazo de las garantías que hubiere otorgado y presente el calendario de avance de obra valorizado actualizado y la programación PERT-CPM, conforme a lo previsto en el artículo 170 del Reglamento de la Ley de Contrataciones del Estado, aprobado por el Decreto Supremo n.º 350-2015-EF y modificado mediante Decreto Supremo n.º 056-2017-EF.

Artículo 3º.- Ampliar el plazo correspondiente al Contrato n.º 030-2017-FONDEPES de la Supervisión por 75 días calendario, conforme a lo expuesto en el Memorando n.º 108-2019-FONDEPES/DIGENIPAA, el Informe n.º 05-2019-FONDEPES-DIGENIPAA/AOEM/LATH y el Informe n.º 023-2019-FONDEPES/OGAJ, ello de conformidad con lo establecido en el artículo 171 del Reglamento de la Ley de Contrataciones del Estado, aprobado por el Decreto Supremo n.º 350-2015-EF y modificado mediante Decreto Supremo N° 056-2017-EF.

Artículo 4º.- Disponer que la Dirección General de Inversión Pesquera Artesanal y Acuícola, comunique a la autoridad competente del Sistema Nacional de Programación Multianual y Gestión de Inversiones la aprobación de la Ampliación de Plazo n.º 14, correspondiente al Contrato n.º 025-2017-FONDEPES, de conformidad con lo establecido en el artículo 170 del Reglamento de la Ley de Contrataciones del Estado, aprobado por el Decreto Supremo n.º 350-2015-EF y modificado mediante Decreto Supremo n.º 056-2017-EF.

Artículo 5º.- Notificar la presente Resolución y sus anexos al contratista, Consorcio Marítimo del Norte, y al supervisor, Cesel S.A.; remitiéndose igualmente copias a la Oficina General de Administración y a la Dirección General de Inversión Pesquera Artesanal y Acuícola, para que ambas, de manera coordinada, ejecuten las acciones que permitan la suscripción de las respectivas adendas al Contrato n.º 025-2017-FONDEPES y Contrato n.º 030-2017-FONDEPES.

Artículo 6º.- Disponer que la presente Resolución y sus anexos se publiquen en el portal Institucional de la Entidad.

Regístrese y comuníquese.

FONDO NACIONAL DE DESARROLLO PESQUERO
FONDEPES
 KARLA ELIZABETH ESPINOZA MALATESTA
 GERENCIA GENERAL



«Decenio de la Igualdad de Oportunidades para Mujeres y Hombres»
«Año de la Lucha contra la Corrupción y la Impunidad»

INFORME N.º 023-2019-FONDEPES/OGAJ

FONDEPES
GERENCIA GENERAL
17 ENE 2019
RECIBIDO
Nº Registro: Hora: 15:34

A : **ABG. KARLA ELIZABETH ESPINOZA MALATESTA**
Gerenta General del Fondepes

Asunto : Solicitud de Ampliación de Plazo n.º 14 al Contrato n.º 025-2017-FONDEPES, «Mejoramiento y recuperación de los servicios del Desembarcadero Pesquero Artesanal de Supe, distrito de Supe Puerto, provincia de Barranca, región Lima».

Referencia : a) Memorando n.º 108-2019-FONDEPES/DIGENIPAA
b) Informe n.º 05-2019-FONDEPES-DIGENIPAA/AOEM/LATH

Fecha : Lima, 17 de enero de 2019

Tengo a bien dirigirme a usted con relación a los documentos de la referencia a fin de remitir el informe legal solicitado, conforme a los siguientes términos:

I. ANTECEDENTES

- 1.1. El 22 de agosto de 2017 el Fondo Nacional de Desarrollo Pesquero (en adelante, Fondepes) y el Consorcio Marítimo del Norte (en adelante, el Contratista), integrado por las empresas Cefolsa Ingeniería y Construcción S.A.C., PCD S.A.C. y Asphalt Technologies S.A.C., suscribieron el Contrato n.º 025-2017-FONDEPES para la ejecución de la obra denominada: «Mejoramiento y recuperación de los servicios del Desembarcadero Pesquero Artesanal de Supe, distrito de Supe Puerto, provincia de Barranca, región Lima» (en adelante, la Obra) por un monto de S/ 21 509 091,48 (veintinueve millones quinientos nueve mil noventa y uno con 48/100 Soles) y un plazo de ejecución de 270 días calendario.
- 1.2. El 15 de setiembre de 2017 el Fondepes y la empresa CESEL S.A. (en adelante, el Supervisor) suscribieron el Contrato n.º 030-2017-FONDEPES para la supervisión de la Obra, por un plazo de ejecución de 270 días calendario.
- 1.3. El 28 de diciembre de 2018, mediante Resolución Jefatural n.º 158-2018-FONDEPES/J, el Fondepes aprobó el expediente técnico de la Prestación Adicional de Obra n.º 6 y el Presupuesto Deductivo Vinculado n.º 5 del Contrato n.º 025-2017-FONDEPES, siendo notificada al Contratista en la misma fecha.
- 1.4. El 29 de diciembre de 2018, mediante carta n.º C204-2018-CMN-SUPE, el Contratista solicitó al Supervisor la Ampliación de Plazo n.º 14 al Contrato n.º 025-2017-FONDEPES, por 75 días calendario para la ejecución de la Prestación Adicional de Obra n.º 6.
- 1.5. El 7 de enero de 2019, mediante carta n.º CSL.174302.PU.DPA.S.252.19 el Supervisor remitió al Fondepes el «Informe Especial N° 46 CSL- 174302.PU.ESP.46 Ampliación de Plazo N° 14», a través del cual considera procedente la solicitud de Ampliación de Plazo n.º 14 presentada por el Contratista.
- 1.6. El 10 de enero de 2019, mediante Informe n.º 05-2019-FONDEPES-DIGENIPAA/AOEM/LATH, la Dirección General de Inversión Pesquera Artesanal y Acuicola (Digenipaa), en calidad de área usuaria y órgano técnico, indicó que resulta procedente aprobar la Ampliación de Plazo n.º 14 solicitada por el Contratista.

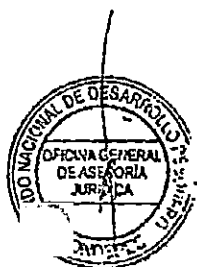

- 1.7. El 11 de enero de 2019, mediante el Memorando n.º 108-2019-FONDEPES/DIGENIPAA, el director de la Digenipaa hizo suyo el Informe n.º 05-2019-FONDEPES-DIGENIPAA/AOEM/LATH, remitiéndolo a la Oficina General de Asesoría Jurídica para que se proyecte el resolutivo correspondiente.

II. BASE LEGAL

- 2.1. Ley n.º 30225, Ley de Contrataciones del Estado, modificada mediante Decreto Legislativo n.º 1341, en adelante la Ley.
- 2.2. Reglamento de la Ley de Contrataciones del Estado aprobado por Decreto Supremo n.º 350-2015-EF, modificado mediante Decreto Supremo n.º 056-2017, en adelante el Reglamento.
- 2.3. Reglamento de Organización y Funciones del Fondepes, aprobado por Resolución Ministerial n.º 346-2012-PRODUCE, en adelante ROF del Fondepes.

III. ANÁLISIS LEGAL

De la ampliación de plazo

- 3.1. El numeral 34.5 del artículo 34 de la Ley dispone que *«el contratista puede solicitar ampliación del plazo pactado por atrasos y/o paralizaciones ajenas a su voluntad, debidamente comprobados y que modifiquen el cronograma contractual»*.

Sobre el particular, debe señalarse que el numeral del artículo 169 del Reglamento¹ establece que el contratista podrá solicitar la ampliación de plazo *«cuando es necesario un plazo adicional para la ejecución de la prestación adicional de obra. En ese caso el contratista amplía el plazo de las garantías que hubiere otorgado»*.

Asimismo, el primer párrafo del artículo 170 del Reglamento² establece que para que proceda una ampliación de plazo de conformidad con lo establecido en el artículo

¹ Artículo 169.- Causales de ampliación de plazo

El contratista puede solicitar la ampliación de plazo pactado por cualquiera de las siguientes causales ajenas a la voluntad del contratista, siempre que modifiquen la ruta crítica del programa de ejecución de obra vigente al momento de la solicitud de ampliación:

1. *Atrasos y/o paralizaciones por causas no atribuibles al contratista.*
2. *Cuando es necesario un plazo adicional para la ejecución de la prestación adicional de obra. En ese caso el contratista amplía el plazo de las garantías que hubiere otorgado.*
3. *Cuando es necesario un plazo adicional para la ejecución de los mayores metros que no provengan de variaciones del expediente técnico de obra, en contratos a precios unitarios.*

² Artículo 170.- Procedimiento de ampliación de plazo

170.1. *Para que proceda una ampliación de plazo de conformidad con lo establecido en el artículo precedente, el contratista, por intermedio de su residente debe anotar en el cuaderno de obra, el inicio y el final de las circunstancias que a su criterio determinen ampliación de plazo. Dentro de los quince (15) días siguientes de concluida la circunstancia invocada, el contratista o su representante legal solicita, cuantifica y sustenta su solicitud de ampliación de plazo ante el Inspector o supervisor, según corresponda, siempre que la demora afecte la ruta crítica del programa de ejecución de obra vigente.*

170.2. *El Inspector o supervisor emite un informe que sustenta técnicamente su opinión sobre la solicitud de ampliación de plazo y lo remite a la Entidad y al contratista en un plazo no mayor de cinco (5) días hábiles, contados desde el día siguiente de presentada la solicitud. La Entidad resuelve sobre dicha ampliación y notifica su decisión al contratista en un plazo máximo de diez (10) días hábiles, contados desde el día siguiente de la recepción del indicado informe o del vencimiento del plazo, bajo responsabilidad. De no emitirse pronunciamiento alguno dentro del plazo señalado, se tiene por aprobado lo indicado por el Inspector o supervisor en su informe.*

170.3. *Si dentro del plazo de quince (15) días hábiles de presentada la solicitud, la entidad no se pronuncia y no existe opinión del supervisor o Inspector, se considera ampliado el plazo solicitado por el contratista. Cuando las ampliaciones se sustenten en causales que no correspondan a un mismo período de tiempo, sea este parcial o total, cada solicitud de ampliación de plazo debe tramitarse y resolverse independientemente.*

170.4. *En tanto se trate de circunstancias que no tengan fecha prevista de conclusión, hecho que debe ser debidamente acreditado y sustentado por el contratista de obra, y no se haya suspendido el plazo de ejecución contractual, el contratista*





00251

«Decenio de la Igualdad de Oportunidades para Mujeres y Hombres»
«Año de la Lucha contra la Corrupción y la Impunidad»

antes mencionado, el contratista, por intermedio de su residente debe anotar en el cuaderno de obra, el inicio y el final de las circunstancias que a su criterio determinen ampliación de plazo. Dentro de los 15 días siguientes de concluida la circunstancia invocada, el contratista o su representante legal solicita, cuantifica y sustenta su solicitud de ampliación de plazo ante el inspector o supervisor, según corresponda, siempre que la demora afecte la ruta crítica del programa de ejecución de obra vigente.

- 3.2. De igual manera, el segundo párrafo del artículo 170 del Reglamento dispone que el Inspector o supervisor debe emitir un informe que sustente técnicamente su opinión sobre la solicitud de ampliación de plazo y lo remite a la Entidad y al contratista en un plazo no mayor de 5 días hábiles, contados desde el día siguiente de presentada la solicitud, en tanto que la Entidad resuelve sobre dicha ampliación y notifica su decisión al contratista en un plazo máximo de 10 días hábiles, contados desde el día siguiente de la recepción del indicado informe o del vencimiento del plazo, siendo que de no emitirse pronunciamiento alguno dentro del plazo señalado, se tiene por aprobado lo indicado por el Inspector o supervisor en su informe, y en caso que dentro del plazo de 15 días hábiles de presentada la solicitud, la entidad no se pronuncie y no exista opinión del supervisor o inspector, se considerará ampliado el plazo solicitado por el contratista.

En razón de ello, de la normativa de Contrataciones del Estado se desprende que un contratista tiene el derecho de solicitar una ampliación del plazo de ejecución de la prestación siempre que se cumplan con las referidas condiciones establecidas en los citados artículos, con la finalidad de que la Entidad apruebe extender el plazo originalmente pactado.

- 3.3. Por lo tanto, a fin de que una Entidad apruebe una solicitud de ampliación del plazo de ejecución de una obra se requiere que: i) se configure alguna de las causales establecidas en el artículo 169 del Reglamento, ii) se anote en el cuaderno de obra el inicio y el final de las circunstancias que a su criterio determinen la ampliación de plazo y de ser el caso, el detalle del riesgo no previsto, señalando su efecto y los hitos afectados no cumplidos, iii) dentro de los 15 días siguientes de concluida la circunstancia invocada, el contratista y su representante legal, solicita, cuantifica y sustenta su solicitud de ampliación de plazo ante el inspector o supervisor, según corresponda, iv) la demora afecte la ruta crítica del programa de ejecución de obra vigente al momento de la solicitud de ampliación y v) el inspector o supervisor emita un informe que sustente técnicamente su opinión sobre la solicitud de ampliación de plazo y lo remita a la Entidad.

Al respecto, cabe precisar que la aprobación de las ampliaciones de plazo contiene un aspecto técnico, por tal motivo, corresponde a la Digenipaa, en su calidad de área usuaria y órgano técnico, verificar la ocurrencia y configuración de la causal de acuerdo a las definiciones previstas en la normativa de Contrataciones del Estado señaladas anteriormente.

- 3.4. En razón a ello, la Digenipaa señala en su Informe n.º 05-2019-FONDEPES-DIGENIPAA/AOEM/LATH que la solicitud de Ampliación de Plazo n.º 14 se ampara en el supuesto recogido en el numeral 2 de artículo 169 del Reglamento, señalándose además que en el presente caso se cumplen los requisitos establecidos en el artículo 170 del Reglamento, dado los siguientes fundamentos:

puede solicitar y la Entidad otorgar ampliaciones de plazo parciales, a fin de permitir que el contratista valorice los gastos generales por dicha ampliación parcial, para cuyo efecto se sigue el procedimiento antes señalado.



«Decenio de la Igualdad de Oportunidades para Mujeres y Hombres»
«Año de la Lucha contra la Corrupción y la Impunidad»

000250

i. Sobre la anotación en el cuaderno de obra y las circunstancias que determinan la ampliación de plazo:

«En cuaderno de obra, con Asiento N° 654 de fecha de 28 de diciembre del 2018 (inicio de la causal), el contratista deja constancia que ha recibido la Resolución Jefatural N°158-2018-FONDEPES/J remitida con Carta N°465-2018-FONDEPES/SG del 28.12.2018, mediante la cual notifican la aprobación del Expediente Técnico del Presupuesto Adicional de Obra N° 06, con el cual se fija el inicio de la causal de la ampliación de plazo N°14. Del mismo modo en el mismo Asiento 654 de fecha 28 de diciembre del 2018 (término de la causal), el residente Indica que la recepción de la Resolución Jefatural N°158-2018-FONDEPES/J, constituye el acto único para el inicio y cese de la causal de ampliación de plazo N°14 para la ejecución de la prestación Adicional de Obra N° 06..»

Como se puede observar, el contratista fue notificado el 28 de diciembre de 2018 con la Resolución Jefatural n.º 158-2018-FONDEPES/J que aprueba el expediente técnico de la Prestación Adicional de Obra n.º 6 y anota dicha circunstancia en el asiento n.º 654 del cuaderno de obra.

De esta manera, el Contratista cumplió con realizar la anotación en el cuaderno de obra que exige el artículo 170.1 del Reglamento como primer requisito para solicitar una ampliación del plazo contractual. Asimismo, el Contratista cumple con identificar la causal que origina su solicitud de ampliación de plazo (Cuando es necesario un plazo adicional para la ejecución de la prestación adicional de obra), conforme a los supuestos establecidos en el artículo 169 del Reglamento.

ii. Sobre la oportunidad de presentación de la solicitud de Ampliación de Plazo:

«(...) La solicitud de ampliación de plazo fue presentada por el representante legal del Contratista Consorcio Marítimo del Norte a la Supervisión el día 29 de diciembre del 2018 con Carta C204-2018-CMN-SUPE.»

Tal como se señala en el numeral anterior, el Contratista anotó el 28 de diciembre de 2018, mediante asiento n.º 654, el inicio y cese de las circunstancias que originan su solicitud ampliación de plazo, y, posteriormente presentó dicha solicitud a la entidad mediante carta n.º C204-2018-CMN-SUPE del 29 de diciembre de 2018, es decir, dentro del plazo de 15 días calendario, contados a partir del día siguiente de concluida la causal, que establece el numeral 170.1 del artículo 170 del Reglamento.

iii. Sobre la afectación de la ruta crítica:

«El expediente de la Prestación Adicional de obra N° 06 aprobada mediante Resolución Jefatural N° 158-2018-FONDEPES/J, adjunta dentro de los anexos un cronograma de ejecución de la mencionada prestación por 77 días calendario (...)

(...)

Se observa en el calendario GANTT donde se ha insertado las partidas del sistema eléctrico de media tensión del Adicional de Obra N° 06, se han vuelto partidas críticas y desplazan la programación hasta el día 15 de marzo del 2019; por lo tanto, los días necesarios para culminar la obra será:

- Fecha de término contractual: 30 de diciembre del 2018
- Fecha de término con el adicional de Obra N° 06: 15 de marzo del 2019.
- Número de días de ampliación: 75 días calendario»

Al respecto, debe señalarse que conforme a la Resolución de Gerencia General n.º 215-2018-FONDEPES/GG del 30 de noviembre de 2018 se extendió el plazo de ejecución contractual hasta el 30 de diciembre de 2018. Sin embargo, el expediente técnico de la Prestación Adicional de Obra n.º 6, aprobada mediante Resolución Jefatural n.º 158-2018-FONDEPES/J, establece un plazo 77 días calendario para su ejecución, el mismo que inició el 29 de diciembre de 2018.

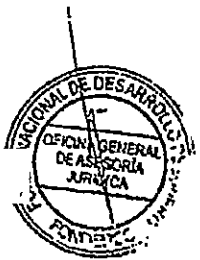

«Decenio de la Igualdad de Oportunidades para Mujeres y Hombres»
«Año de la Lucha contra la Corrupción y la Impunidad»

000240

Por tal motivo, la Digenipaa señala que en el presente caso existe afectación de la ruta crítica y corresponde otorgar los 75 días calendario solicitados por el Contratista.

iv. Opinión del Supervisor:

«La supervisión de la obra CESEL SA, mediante Carta CSL.174302.PU.DPA.S.251.18 del 07 de enero del 2018 e Informe N° CSL.174302.PU.IN.ESP.46 adjunto, recomienda emitir la resolución declarando procedente la solicitud de Ampliación de Plazo N° 14 por 75 días calendario.»

v. Sobre la determinación del plazo de ampliación:

«(...) se concluye que la ampliación del plazo PROCEDE por 75 días calendario, plazo necesario para alcanzar la finalidad del contrato y el cual se justifica por los trabajos que implica la ejecución de la Prestación Adicional de Obra N° 06, que corresponden a las partidas del sistema eléctrico de la Medía Tensión; según el análisis expuesto en el presente informe y conforme al Reglamento de la Ley de Contrataciones del Estado y del Contrato.»

vi. Sobre la necesidad de Ampliar el Plazo al Contrato de Supervisión:

«En el mismo sentido, en aplicación del ítem 171.3 del artículo 171° del Reglamento de la Ley de Contrataciones del Estado, la Entidad debe ampliar el plazo de los servicios de la supervisión por 75 días calendario, en virtud de la ampliación de plazo otorgada vinculado al contrato principal.»

Sobre este punto, cabe señalar que el artículo 159 del Reglamento dispone que durante la ejecución de una obra debe contarse de modo permanente y directo con un inspector o con un supervisor, según corresponda. Asimismo, el artículo 171.3 del Reglamento establece que en virtud de la ampliación de plazo otorgada, la Entidad debe ampliar el plazo de los otros contratos celebrados por ésta y vinculados directamente al contrato principal, por lo que, en el presente caso corresponde ampliar el plazo del Contrato n.° 030-2017-FONDEPES por el número de días indicado por la Digenipaa.



3.5. En atención a lo expuesto, se advierte que concurren la condiciones legales para otorgar la Ampliación de Plazo n.° 14 solicitada por el Consorcio Marítimo del Norte, en el marco del Contrato n.° 025-2017-FONDEPES, para la ejecución de la obra: «Mejoramiento y recuperación de los servicios del Desembarcadero Pesquero Artesanal de Supe, Distrito de Supe Puerto, Provincia de Barranca, Región Lima», por el plazo de 75 días calendario, estableciéndose en consecuencia, como fecha final de la ejecución de la Obra el 15 de marzo de 2019.

Del plazo para el pronunciamiento

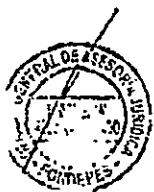

3.6. El artículo 170 del Reglamento establece que el inspector o supervisor debe emitir un Informe que sustente técnicamente su opinión sobre la solicitud de ampliación de plazo y lo remite a la Entidad y al contratista en un plazo no mayor de 5 días hábiles, contados desde el día siguiente de presentada la solicitud. Por su parte, la Entidad resuelve sobre dicha ampliación y notifica su decisión al contratista en un plazo máximo de 10 días hábiles, contados desde el día siguiente de la recepción del indicado Informe o del vencimiento del plazo.

Asimismo, el citado artículo dispone que de no emitirse pronunciamiento alguno por parte de la Entidad dentro del plazo señalado, se tendrá por aprobado lo indicado por el Inspector o supervisor en su Informe y, si dentro del plazo de 15 días hábiles de presentada la solicitud del contratista, la Entidad no se pronuncia y tampoco existiera opinión del supervisor o inspector, se considerará ampliado el plazo solicitado por el contratista.



«Decenio de la Igualdad de Oportunidades para Mujeres y Hombres»
«Año de la Lucha contra la Corrupción y la Impunidad»

000018

- 3.7. De la documentación remitida por la Digenipaa, se aprecia que el 29 de diciembre de 2018, mediante la carta n.º C204-2018-CMN-SUPE, el Contratista solicitó a la Supervisión la Ampliación de Plazo n.º 14 por 75 días calendario. En tanto que, el 7 de enero de 2019, mediante la carta n.º CSL.174302.PU.DPA.S.251.19, la Supervisión remitió al Fondepes el informe respectivo; por lo que, al encontrarse dentro del plazo establecido en el artículo 170 del Reglamento, corresponde al Fondepes emitir y notificar su pronunciamiento dentro de los 10 días hábiles siguientes del pronunciamiento del supervisor; es decir, corresponde resolver sobre la solicitud de Ampliación de Plazo n.º 14 y notificar dicha decisión al Contratista hasta el 21 de enero de 2019.

De la competencia para la aprobación de la Ampliación de Plazo

- 3.8. En relación al funcionario legitimado para emitir pronunciamiento respecto a la solicitud de ampliación de plazo, cabe indicar que en virtud de lo establecido en el literal e) del artículo 1 de la Resolución Jefatural n.º 069-2016-FONDEPES/J, se delegó en la Gerencia General de Fondepes, entre otras, la facultad de resolver las solicitudes de ampliación de plazo para el caso de las contrataciones de ejecuciones de obras y consultorías de obras; por tanto, corresponde a su Despacho expedir el acto resolutorio correspondiente.

De la responsabilidad

- 3.9. Finalmente, cabe indicar que la presente evaluación se enmarca únicamente sobre los presupuestos legales para la aprobación de ampliaciones de plazo de conformidad con lo dispuesto en los artículos 169, 170 y 171 del Reglamento, siendo que la responsabilidad del análisis técnico, así como la determinación del plazo de ampliación, corresponde únicamente a la Digenipaa en su calidad de área usuaria y órgano técnico, en el marco de la Ley y su Reglamento y de acuerdo a los artículos 21 y 22 del Reglamento de Organización y Funciones del Fondepes, aprobado por Resolución Ministerial n.º 346-2012-PRODUCE.

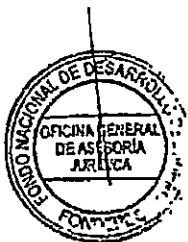

IV. CONCLUSIONES:

Estando a lo expuesto en el Informe n.º 05-2019-FONDEPES-DIGENIPAA/AOEM/LATH, esta Oficina General de Asesoría Jurídica OPINA y RECOMIENDA lo siguiente:



- 4.1. Concurren las condiciones legales para otorgar la Ampliación de Plazo n.º 14 solicitada por el Contratista, en el marco del Contrato n.º 025-2017-FONDEPES para la ejecución de la obra: «Mejoramiento y recuperación de los servicios del Desembarcadero Pesquero Artesanal de Supe, distrito de Supe Puerto, provincia de Barranca, región Lima», por el plazo de 75 días calendario, estableciéndose en consecuencia, como nueva fecha final de la ejecución de la Obra el 15 de marzo de 2019, de acuerdo a lo señalado en el Informe n.º 05-2019-FONDEPES/DIGENIPAA/AOEM/LATH.
- 4.2. Disponer que el Contratista amplíe el plazo de las garantías que hubiere otorgado y presente el calendario de avance de obra valorizado actualizado y la programación PERT-CPM, conforme a lo previsto en el artículo 170 del Reglamento.
- 4.3. Comunicar a la autoridad competente del Sistema Nacional de Programación Multianual y Gestión de Inversiones la aprobación de la solicitud de Ampliación de Plazo n.º 14, correspondiente al Contrato n.º 025-2017-FONDEPES, de conformidad con lo establecido en el artículo 170 del Reglamento.





«Decenio de la Igualdad de Oportunidades para Mujeres y Hombres»
«Año de la Lucha contra la Corrupción y la Impunidad»

000047

- 4.4. Corresponderá, de conformidad con lo establecido en el artículo 171 del Reglamento, ampliar el plazo del Contrato n.º 030-2017-FONDEPES de la Supervisión, por 75 días calendario, conforme a lo indicado en el Informe n.º 005-2019-FONDEPES-DIGENIPAA/AOEM/LATH.
- 4.5. Notificar la Resolución de Gerencia General al Consorcio Marítimo del Norte y a la supervisión Cesel S.A., remitiéndose copia a la Oficina General de Administración para que en coordinación con la Dirección General de Inversión Pesquera Artesanal y Acuícola, ejecuten las acciones que permitan la suscripción de las adendas correspondientes a los Contrato n.º 025-2017-FONDEPES y Contrato n.º 030-2017-FONDEPES.
- 4.6. Para realizar el acto de aprobación descrito será necesario elevar el presente Informe y sus antecedentes a la Gerencia General, a fin que expida el acto administrativo aprobatorio, ejerciendo las facultades delegadas, conforme a la Resolución Jefatural n.º 069-2016-FONDEPES/J.

En tal virtud, se acompaña con el presente, el proyecto de resolución para el trámite correspondiente.

Atentamente,

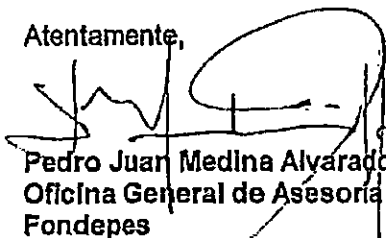
Pedro Juan Medina Alvarado
Oficina General de Asesoría Jurídica
Fondepes

El Jefe de la Oficina General de Asesoría Jurídica que suscribe, hace suyo el presente informe.

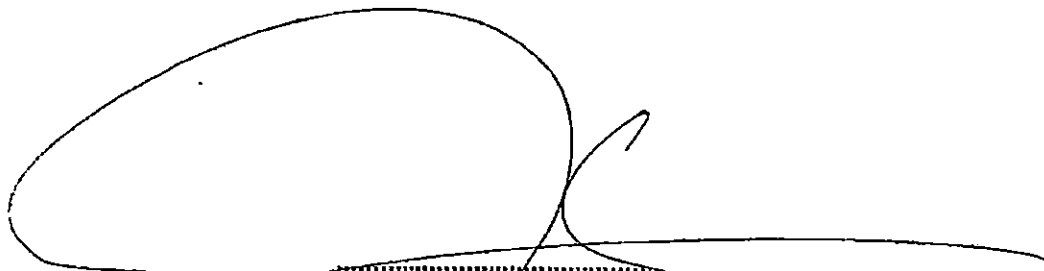
Abog. WALTER JAVIER IBEROS GUEVARA
Jefe de la Oficina General de Asesoría Jurídica
FONDO NACIONAL DE DESARROLLO PESQUERO



PERÚ

Ministerio de la Producción

FONDEPES
Fondo Nacional de Desarrollo Pesquero

"Decenio de la Igualdad de Oportunidades para Mujeres y Hombres"

000245

MEMORANDO N° 108 - 2019-FONDEPES/DIGENIPAA

A : Walter Javier Iberos Guevara
Jefe de la Oficina General de Asesoría Jurídica

Asunto : Emisión Resolución sobre solicitud de Ampliación de Plazo N° 14
Licitación Pública N° 0001-2017-FONDEPES
"MEJORAMIENTO Y RECUPERACION DE LOS SERVICIOS DEL
DESEMBARCADERO PESQUERO ARTESANAL DE SUPE,
DISTRITO DE SUPE PUERTO, PROVINCIA DE BARRANCA, REGION
LIMA".

Referencia : a) Carta CSL.174302.PU.DPA.S.251.18 del 07.01.2019.
b) INFORME N° CSL.174302.PU.IN.ESP.46
c) Carta C204-2018/SUPE y Expediente del 29.12.2018.
d) INFORME N° 05-2019-FONDEPES-DIGENIPAA/AOEM/LATH
e) Contrato N° 025-2017-FONDEPES

Fecha : Lima, 11 ENE 2019

Es grato dirigirme a usted, para solicitarle tenga a bien autorizar a quien corresponda elabore la resolución correspondiente sobre la Ampliación de Plazo N° 14 solicitado por el contratista CONSORCIO MARITIMO DEL NORTE mediante los documentos de la referencia c); para lo cual se adjuntan a la presente los documentos de la referencia a), b) y el documento d) el cual hago mfo en toda su extensión; en cumplimiento del artículo 170° del Reglamento de la Ley de Contrataciones del Estado.

En ese sentido, se recomienda comunicar al contratista CONSORCIO MARITIMO DEL NORTE, mediante la resolución respectiva sobre la procedencia de la solicitud de Ampliación de Plazo N° 14 y remitir notificación con copia a la supervisión CESEL SA, en una fecha no mayor al 21.01.2018.

Atentamente,

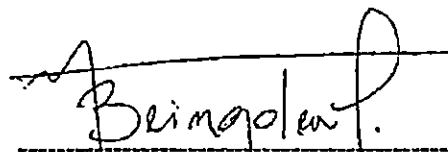
Ing. Fernando Beingolea More
Director (e) General de Inversión
Pesquera Artesanal y Acuicola

LBQ/LATH

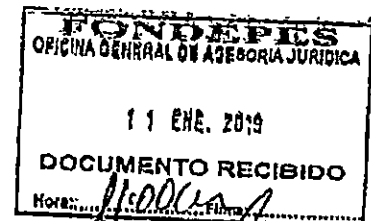

"Decenio de la Igualdad de Oportunidades para Mujeres y Hombres"

INFORME N° 05-2019-FONDEPES-DIGENIPAA/AOEM/LATH

Atención : **ING. LUIS ALBERTO BARBIERI QUINO**
Director General de Inversión Pesquera, Artesanal y Acuicultura

Asunto : **Solicitud de Ampliación de Plazo N° 14 - DPA Supe:**
Licitación Pública N° 0001-2017-FONDEPES
Mejoramiento y Recuperación de los Servicios del Desembarcadero
Pesquero Artesanal de Supe, Distrito de Supe Puerto, Provincia de
Barranca, Región Lima".

Referencia : a) Memorándum Interno N° 101-2019-FONDEPES/DIGENIPAA/AOEM
b) Memorándum Interno N° 120-2019-FONDEPES/DIGENIPAA
c) Carta CLS.174302.PU.DPA.S.251.19 del 07.01.2019.
d) Informe N° CSL-174302.PU.IN.ESP.46 - Ampliación de Plazo N° 14
e) Carta C204-2018-CMN-SUPE del 29.12.2018
f) Expediente de Ampliación de Plazo N° 14.
g) Contrato N° 25-2017-FONDEPES

Fecha : **Enero, 09 del 2018.**

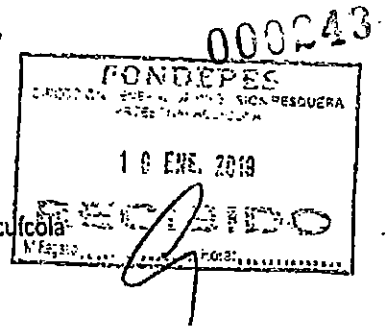

De mi consideración:

Es grato dirigirme a usted en atención a los documentos c), d), e) y f) sobre la solicitud de Ampliación de Plazo N° 14 de la obra: "Mejoramiento y Recuperación de los Servicios del Desembarcadero Pesquero Artesanal de Supe, Distrito de Supe Puerto, Provincia de Barranca, Región Lima", que solicita el contratista CONSORCIO MARITIMO DEL NORTE; al respecto puedo informar:

I. DATOS GENERALES DESEMBARCADERO PESQUERO ARTESANAL DE SUPE

Proceso : L.P. N° 0001-2017-FONDEPES (1ra. Convocatoria)
Código SNIP N° : 182813
Contrato : N° 025-2017-FONDEPES
Obra : Mejoramiento y Recuperación de los Servicios del Desembarcadero Pesquero Artesanal de Supe, Distrito de Supe Puerto, Provincia de Barranca, Región Lima".

Sistema : A precios Unitarios
Monto Obra : S/. 21'509,091.48 (incluye IGV)
Adic. Obra 01 : S/. 2'213,942.02 - R.J. N° 008-2018-FONDEPES/J del 18.01.18
Deduc. Vinc. 01 : S/. 1'879,271.36 - R. J. N° 008-2018-FONDEPES/J del 18.01.18.
Adic. Obra 02 : S/. 160,884.74 - R.J. N° 052-2018-FONDEPES/J del 18.05.18
Adic. Obra 03 : S/. 676,072.37 - R.J. N° 094-2018-FONDEPES/J del 22.08.18
Deduc. Vinc. 02 : S/. 242,870.31
Adic. Obra 04 : S/. 417,954.90 - R.J. N° 095-2018-FONDEPES/J del 22.08.18



"Decenio de la Igualdad de Oportunidades para Mujeres y Hombres"

000242

Deduc. Vinc. 03 : S/. 220,209.97
Adic. Obra 05 : S/. 562,775.06 – R.J. N° 133-2018-FONDEPES/J del 26.10.18
Deduc. Vinc. 04 : S/. -187,675.96
Adic. Obra 06 : S/. 340,246.17 – R.J. N° 158-2018-FONDEPES/J del 28.12.18
Deduc. Vinc. 05 : S/. -339,697.56
Total Adicional : S/. 1'502,150.10 (6.98%)
Monto Vigente : S/. 23'011,241.58 (Incluye IGV)
Contratista : CONSORCIO MARITIMO DEL NORTE
Residente : Ing. Daniel J. Morales Vivanco.
Supervisión : CESEL S.A.
Supervisor : Ing. Ludwig Carrasco Bustamante
Fecha de Inicio : 19 de setiembre del 2017
Plazo Ejecución : 270 días calendario
Término Inicial : 15 de junio del 2018
Ampliac. N° 01 : 16 d.c. (Denegada).
Ampliac. N° 02 : 67 d.c. (Denegada con Resolución de S.G. N° 001-2018-FONDEPES/SG).
Ampliac. N° 03 : 42 d.c. (Aprobada con Resolución de S.G. N° 028-2018-FONDEPES/SG).
Término : 27 de julio del 2018.
Ampliac. N° 04 : 32 d.c. (Aprobada con Resolución de S.G. N° 029-2018-FONDEPES/SG).
Nvo. Término : 28 de agosto del 2018.
Ampliac. N° 05 : 28 d.c. (Resolución de Secretaría General N° 110-2018-FONDEPES/SG)
Nvo. Término : 25 de setiembre del 2018.
Ampliac. N° 06 : 120 d.c. (Denegada con Resolución de S.G. N° 111-2018-FONDEPES/SG).
Ampliac. N° 07 : 19 d.c. (Denegada con Resolución de S.G. N° 112-2018-FONDEPES/SG).
Ampliac. N° 08 : 52 d.c. (Aprobada con Resolución de S.G. N° 171-2018-FONDEPES/SG).
Término : 16 de noviembre del 2018.
Ampliac. N° 09 : 57 d.c. (Denegada con Resolución de S.G. N° 172-2018-FONDEPES/SG).
Ampliac. N° 10 : 44 d.c. (Aprobada con Resolución de S.G. N° 215-2018-FONDEPES/SG).
Término : 30 de diciembre del 2018.
Ampliac. N° 11 : 43 d.c. (Denegada con Resolución de S.G. N° 216-2018-FONDEPES/SG).
Ampliac. N° 12 : 4 d.c. (Denegada con Resolución de S.G. N° 217-2018-FONDEPES/SG).
Avance Físico : 50.00 %



II. ANTECEDENTES

1.1 Antecedentes Generales:

- Con fecha 24 de Julio del 2017, el Comité de Selección como resultado del Proceso de Selección LICITACION PUBLICA: N° 0001-2017-FONDEPES para la ejecución de la obra: "Mejoramiento y Recuperación de los Servicios del Desembarcadero Pesquero Artesanal de Supe, Distrito de Supe Puerto, Provincia de Barranca, Región Lima", adjudico la Buena Pro al CONSORCIO MARITIMO DEL NORTE, por el monto de S/. 21'509,091.48 y un plazo de ejecución de 270 días calendario; suscribiéndose el Contrato N° 025-2017-FONDEPES con fecha 22 de agosto del 2017.

Página 2 de 15



- Con fecha 29 de agosto del 2017, el Comité de Selección como resultado del Proceso de Selección CONCURSO PUBLICO N° 0001-2017-FONDEPES para la consultoría de la supervisión de la obra: "Mejoramiento y Recuperación de los Servicios del Desembarcadero Pesquero Artesanal de Supe, Distrito de Supe Puerto, Provincia de Barranca, Región Lima", adjudicó la Buena Pro a la empresa CESEL S.A. por el monto de S/. 1'651,890.27 y con un plazo del servicio por 270 días calendario; suscribiéndose el Contrato N° 030-2017-FONDEPES con fecha 15 de setiembre del 2017.

1.2 Antecedentes Específicos:

Ampliación de Plazo N° 01

- Con Carta CMN-026-2017/SUPE y Expediente adjunto de fecha 25 de octubre del 2017 dirigida a la supervisión CESEL SA, el contratista de obra CONSORCIO MARITIMO DEL NORTE, solicita la Ampliación de Plazo N° 01 por 16 días calendario.
- Mediante Carta ED.174302.PU.09.DPA.S e Informe Especial N° CSL.174302.PU.ESP.05 de fecha 31 de octubre del 2017, dirigida al FONDEPES, la supervisión CESEL SA emite opinión declarando Improcedente la solicitud de Ampliación de Plazo N° 01.
- Con Carta CSL 174302.PU.DPA.S.01.17 del 07 de noviembre del 2017, la supervisión CESEL SA comunica al contratista CONSORCIO MARITIMO DEL NORTE, sobre la Improcedencia de la Ampliación de Plazo N° 01.
- Con Carta N° 430-2017-FONDEPES/DIGENIPAA del 07 de noviembre del 2017, el FONDEPES notifica al contratista CONSORCIO MARITIMO DEL NORTE, sobre la Improcedencia de la Ampliación de Plazo N° 01 por 16 días calendario.

Ampliación de Plazo Parcial N° 02

- Con Carta C047-2017-CMN-SUPE y Expediente adjunto de fecha 11 de diciembre del 2017, el contratista de obra CONSORCIO MARITIMO DEL NORTE, solicita a la supervisión CESEL SA la Ampliación de Plazo N° 02 por 67 días calendario.
- Mediante Carta ED.174302.PU.023.17.DPA.S e Informe Especial N° CSL.174302.PU.ESP.06.17 de fecha 15 de diciembre del 2017, dirigida al FONDEPES, la supervisión CESEL SA emite opinión sobre la procedencia parcial de solicitud de Ampliación Parcial de Plazo N° 02, por 46 días calendario.
- Con Carta CSL 174302.PU.DPA.S.09.17 del 18 de diciembre del 2017, la supervisión CESEL SA comunica al contratista CONSORCIO MARITIMO DEL NORTE, sobre la procedencia parcial de la Ampliación de Plazo N° 02, por 46 días calendario.
- Mediante Resolución de Secretaria General N° 001-2018-FONDEPES/SG del 03 de enero del 2018 y notificada al contratista mediante Carta N° 001-2018-FONDEPES/SG del 03 de enero del 2018, se declara Improcedente la solicitud de Ampliación de Plazo Parcial N° 02.

Ampliación de Plazo N° 03

- Con Carta CMN-001-2018/SUPE y Expediente adjunto de fecha 31 de enero del 2018, el contratista de obra CONSORCIO MARITIMO DEL NORTE, solicita a la supervisión CESEL SA la Ampliación de Plazo N° 03 por 42 días calendario.

Página 3 de 15



'Decenio de la Igualdad de Oportunidades para Mujeres y Hombres'

000240

- Con Carta CSL 174302.PU.DPA.S.04.18 del 07 de febrero del 2018, la supervisión CESEL SA comunica al contratista CONSORCIO MARITIMO DEL NORTE, sobre la procedencia de la Ampliación de Plazo N° 03, por 42 días calendario.
- Mediante Carta CSL.174302.PU.046.18.DPA.S e Informe N° CSL.174302.PU.ESP.12.18 de fecha 07 de febrero del 2018, dirigida al FONDEPES, la supervisión CESEL SA emite opinión sobre la procedencia por 42 días calendario de la solicitud de Ampliación de Plazo N° 03.
- Mediante Resolución de Secretaría General N° 028-2018-FONDEPES/SG del 21 de febrero del 2018 y notificada al contratista mediante Carta N° 033-2018-FONDEPES/SG del 21.02.2018, se resuelve aprobar la solicitud de Ampliación de Plazo N° 03 por 42 días calendario, siendo el nuevo termino de obra, el 27 de julio del 2018.

Ampliación de Plazo N° 04

- Con Carta CMN-002-2018/SUPE y Expediente adjunto de fecha 31 de enero del 2018, el contratista de obra CONSORCIO MARITIMO DEL NORTE, solicita a la supervisión CESEL SA la Ampliación de Plazo N° 04 por 116 días calendario.
- Con Carta CSL 174302.PU.DPA.S 05.18 del 07 de febrero del 2018, la supervisión CESEL SA comunica al contratista CONSORCIO MARITIMO DEL NORTE, sobre la procedencia de la Ampliación de Plazo N° 04, por 32 días calendario.
- Mediante Carta CSL.174302.PU.047.18.DPA.S e Informe N° CSL.174302.PU.ESP.13.18 de fecha 07 de febrero del 2018, dirigida al FONDEPES; la supervisión CESEL SA emite opinión sobre la procedencia por 32 días calendario de la solicitud de Ampliación de Plazo N° 04.
- Mediante Resolución de Secretaría General N° 029-2018-FONDEPES/SG del 21 de febrero del 2018 y notificada al contratista mediante Carta N° 035-2018-FONDEPES/SG del 21.02.2018, se resuelve aprobar la solicitud de Ampliación de Plazo Parcial N° 04 por 32 días calendario, siendo el nuevo termino de obra el 28 de agosto del 2018.

Ampliación de Plazo N° 05

- Con Carta C074-2018-SUPE y Expediente adjunto de fecha 04 de junio del 2018, el contratista de obra CONSORCIO MARITIMO DEL NORTE, solicita a la supervisión CESEL SA la Ampliación de Plazo N° 05 por 122 días calendario.
- Con Carta CSL 174302.PU.DPA.S.40.18 del 08 de junio del 2018, la supervisión CESEL SA comunica al contratista CONSORCIO MARITIMO DEL NORTE, sobre la procedencia de la Ampliación de Plazo N° 05, por 28 días calendario.
- Mediante Carta CSL.174302.PU.DPA.S.39.18 e Informe N° CSL.174302.PU.ESP.20.18- Ampliación de Plazo N° 05 adjunto de fecha 11 de junio del 2018, dirigida al FONDEPES; la supervisión CESEL SA emite opinión sobre la procedencia por 28 días calendario de la solicitud de Ampliación de Plazo N° 05.
- Mediante Resolución de Secretaría General N° 110-2018-FONDEPES/SG del 22 de junio del 2018 y notificada al contratista mediante Carta N° 213-2018-FONDEPES/SG del 25.06.2018, se resuelve aprobar la solicitud de Ampliación de Plazo Parcial N° 05 por 28 días calendario; siendo el nuevo termino de obra el 25 de setiembre del 2018.

Página 4 de 15



Ampliación de Plazo N° 06

- Con Carta C075-2018-SUPE y Expediente adjunto de fecha 04 de junio del 2018, el contratista de obra CONSORCIO MARITIMO DEL NORTE, solicita a la supervisión CESEL SA la Ampliación de Plazo N° 06 por 120 días calendario.
- Con Carta CSL 174302.PU.DPA.S.44.18 del 08 de junio del 2018, la supervisión CESEL SA comunica al contratista CONSORCIO MARITIMO DEL NORTE, sobre la improcedencia de la Ampliación de Plazo N° 06.
- Mediante Carta CSL.174302.PU.DPA.S.41.18 e Informe N° CSL.174302.PU.ESP.21.18- Ampliación de Plazo N° 06 adjunto de fecha 11 de junio del 2018, dirigida al FONDEPES; la supervisión CESEL SA emite opinión sobre la improcedencia de la solicitud de Ampliación de Plazo N° 06.
- Mediante Resolución de Secretaría General N° 111-2018-FONDEPES/SG del 22 de junio del 2018 y notificada al contratista mediante Carta N° 209-2018-FONDEPES/SG del 25 de junio del 2018, se declara improcedente la solicitud de Ampliación de Plazo N° 06.

Ampliación de Plazo N° 07

- Con Carta C076-2018-SUPE y Expediente adjunto de fecha 04 de junio del 2018, el contratista de obra CONSORCIO MARITIMO DEL NORTE, solicita a la supervisión CESEL SA, la Ampliación de Plazo N° 07 por 19 días calendario.
- Con Carta CSL 174302.PU.DPA.S.44.18 del 08 de junio del 2018, la supervisión CESEL SA comunica al contratista CONSORCIO MARITIMO DEL NORTE, sobre la improcedencia de la Ampliación de Plazo N° 07.
- Mediante Carta CSL.174302.PU.DPA.S.43.18 e Informe N° CSL.174302.PU.ESP.22.18- Ampliación de Plazo N° 07 adjunto de fecha 11 de junio del 2018, dirigida al FONDEPES; la supervisión CESEL SA emite opinión sobre la improcedencia de la solicitud de Ampliación de Plazo N° 07.
- Mediante Resolución de Secretaría General N° 112-2018-FONDEPES/SG del 22 de junio del 2018 y notificada al contratista mediante Carta N° 211-2018-FONDEPES/SG del 25 de junio del 2018, se declara improcedente la solicitud de Ampliación de Plazo N° 07.

Ampliación de Plazo N° 08

- Con Carta C123-2018-SUPE y Expediente adjunto de fecha 06 de setiembre del 2018, el contratista de obra CONSORCIO MARITIMO DEL NORTE, solicita a la supervisión CESEL SA, la Ampliación de Plazo N° 08 por 72 días calendario.
- Con Carta CSL 174302.PU.DPA.S.102.18 del 13 de setiembre del 2018, la supervisión CESEL SA comunica al contratista CONSORCIO MARITIMO DEL NORTE, sobre la procedencia parcial de la Ampliación de Plazo N° 08, por 52 días calendario.
- Mediante Carta CSL.174302.PU.DPA.S.98.18 e Informe N° CSL.174302.PU.ESP.29.18- Ampliación de Plazo N° 08 adjunto de fecha 13 de setiembre del 2018, dirigida al FONDEPES; la supervisión CESEL SA emite opinión sobre la procedencia de la solicitud de Ampliación de Plazo N° 08, indicando que el término del plazo de obra se postergaría hasta el 16.11.2018.
- Mediante Resolución de Secretaría General N° 171-2018-FONDEPES/SG del 26 de setiembre del



2018 y notificada al contratista mediante Carta N° 341-2018-FONDEPES/SG del 26.09.2018, se resuelve aprobar la solicitud de Ampliación de Plazo Parcial N° 08 por 52 días calendario; siendo el nuevo termino de obra el 16 de noviembre del 2018.

Ampliación de Plazo N° 09

- Con Carta C124-2018-SUPE y Expediente adjunto de fecha 06 de setiembre del 2018, el contratista de obra CONSORCIO MARITIMO DEL NORTE, solicita a la supervisión CESEL SA, la Ampliación de Plazo N° 09 por 57 días calendario.
- Con Carta CSL 174302.PU.DPA.S.103.18 del 13 de setiembre del 2018, la supervisión CESEL SA comunica al contratista CONSORCIO MARITIMO DEL NORTE, sobre la Improcedencia de la Ampliación de Plazo N° 09.
- Mediante Carta CSL.174302.PU.DPA.S.99.18 e Informe N° CSL.174302.PU.ESP.30.18- Ampliación de Plazo N° 09 adjunto de fecha 13 de setiembre del 2018, dirigida al FONDEPES; la supervisión CESEL SA emite opinión sobre la Improcedencia de la solicitud de Ampliación de Plazo N° 09.
- Mediante Resolución de Secretaria General N° 172-2018-FONDEPES/SG del 26 de setiembre del 2018 y notificada al contratista mediante Carta N° 343-2018-FONDEPES/SG del 26 de setiembre del 2018, se declara improcedente la solicitud de Ampliación de Plazo N° 09.

Ampliación de Plazo N° 10

- Con Carta C163-2018-SUPE y Expediente adjunto de fecha 13 de noviembre del 2018, el contratista de obra CONSORCIO MARITIMO DEL NORTE, solicita a la supervisión CESEL SA, la Ampliación de Plazo N° 10 por 113 días calendario.
- Con Carta CSL 174302.PU.DPA.S.181.18 del 19 de noviembre del 2018, la supervisión CESEL SA comunica al contratista CONSORCIO MARITIMO DEL NORTE, sobre la procedencia parcial de la Ampliación de Plazo N° 10, por 54 días calendario.
- Con Carta CSL.174302.PU.DPA.S.78.18 e Informe N° CSL.174302.PU.IN.ESP.39.18 - Ampliación de Plazo N° 10 adjunto de fecha 20 de noviembre del 2018, dirigida al FONDEPES; la supervisión CESEL SA emite opinión sobre la procedencia de la solicitud de Ampliación de Plazo N° 10 por 54 días calendario, indicando que el término del plazo de la obra se traslada hasta el 09.01.2019.
- Mediante Resolución de Secretaria General N° 215-2018-FONDEPES/GG del 30 de noviembre del 2018 y notificada al contratista mediante Carta N° 434-2018-FONDEPES/GG del 03.12.2018, se resuelve aprobar en parte la solicitud de Ampliación de Plazo Parcial N° 11 por 44 días calendario; siendo el nuevo termino de obra el 30 de diciembre del 2018.

Ampliación de Plazo N° 11

- Con Carta C164-2018-SUPE y Expediente adjunto de fecha 13 de noviembre del 2018, el contratista de obra CONSORCIO MARITIMO DEL NORTE, solicita a la supervisión CESEL SA, la Ampliación de Plazo N° 11 por 43 días calendario.
- Con Carta CSL 174302.PU.DPA.S.182.18 del 19 de noviembre del 2018, la supervisión CESEL SA comunica al contratista CONSORCIO MARITIMO DEL NORTE, sobre la improcedencia de la solicitud de Ampliación de Plazo N° 11.





- Con Carta CSL.174302.PU.DPA.S.179.18 e Informe N° CSL.174302.PU.IN.ESP.40.18 - Ampliación de Plazo N° 11 adjunto de fecha 20 de noviembre del 2018, dirigida al FONDEPES; la supervisión CESEL SA emite opinión sobre la improcedencia de la solicitud de Ampliación de Plazo N° 11.
- Mediante Resolución de Secretaria General N° 216-2018-FONDEPES/GG del 30 de noviembre del 2018 y notificada al contratista con Carta N° 436-2018-FONDEPES/SG del 03 de diciembre del 2018, se resuelve declarar improcedente la solicitud de Ampliación de Plazo N° 11.

Ampliación de Plazo N° 12

- Con Carta C165-2018-SUPE y Expediente adjunto de fecha 13 de noviembre del 2018, el contratista de obra CONSORCIO MARITIMO DEL NORTE, solicita a la supervisión CESEL SA, la Ampliación de Plazo N° 12 por 4 días calendario.
- Con Carta CSL.174302.PU.DPA.S.180.18 e Informe N° CSL.174302.PU.IN.ESP.41 - Ampliación de Plazo N° 12 adjunto de fecha 20 de noviembre del 2018, dirigida al FONDEPES; la supervisión CESEL SA emite opinión sobre la improcedencia de la solicitud de Ampliación de Plazo N° 12.
- Con Carta CSL 174302.PU.DPA.S.183.18 del 19 de noviembre del 2018, la supervisión CESEL SA comunica al contratista CONSORCIO MARITIMO DEL NORTE, sobre la improcedencia de la solicitud de Ampliación de Plazo N° 12.
- Mediante Resolución de Secretaria General N° 217-2018-FONDEPES/GG del 30 de noviembre del 2018 y notificada al contratista con Carta N° 438-2018-FONDEPES/SG del 03 de diciembre del 2018, se resuelve declarar improcedente la solicitud de Ampliación de Plazo N° 12.

Ampliación de Plazo N° 13 (Trámite en proceso)

- Con Carta C203-2018-SUPE y Expediente adjunto de fecha 29 de diciembre del 2018, el contratista de obra CONSORCIO MARITIMO DEL NORTE, solicita a la supervisión CESEL SA, la Ampliación de Plazo N° 13 por 58 días calendario.
- Con Carta CSL.174302.PU.DPA.S.249.18 e Informe N° CSL.174302.PU.IN.ESP.45 - Ampliación de Plazo N° 13 adjunto de fecha 07 de enero del 2018, dirigida al FONDEPES; la supervisión CESEL SA emite opinión sobre la improcedencia de la solicitud de Ampliación de Plazo N° 13.
- Con Carta CSL 174302.PU.DPA.S.250.18 del 07 de enero del 2019, la supervisión CESEL SA comunica al contratista CONSORCIO MARITIMO DEL NORTE, sobre la improcedencia de la solicitud de Ampliación de Plazo N° 13.

Ampliación de Plazo N° 14 (Trámite actual)

- Con Carta C204-2018-SUPE y Expediente adjunto de fecha 29 de diciembre del 2018, el contratista de obra CONSORCIO MARITIMO DEL NORTE, solicita a la supervisión CESEL SA, la Ampliación de Plazo N° 14 por 75 días calendario.
- Con Carta CSL.174302.PU.DPA.S.251.18 e Informe N° CSL.174302.PU.IN.ESP.46 - Ampliación de Plazo N° 14 adjunto de fecha 07 de enero del 2018, dirigida al FONDEPES; la supervisión CESEL SA emite opinión sobre la procedencia en parte de solicitud de Ampliación de Plazo N° 14.
- Con Carta CSL 174302.PU.DPA.S.252.18 del 07 de enero del 2019, la supervisión CESEL SA comunica al contratista CONSORCIO MARITIMO DEL NORTE, sobre la procedencia en parte de la solicitud de Ampliación de Plazo N° 14.



"Decenio de la Igualdad de Oportunidades para Mujeres y Hombres"

III. MATERIA: SOLICITUD DE AMPLIACION DE PLAZO N° 14

000236

3.1.- MARCO LEGAL:

Generales:

- Ley N° 30225, Ley de Contrataciones del Estado modificada por Decreto Legislativo N° 1341 y su Reglamento, aprobado por D.S. N° 350-2015-EF y modificado por D.S. N° 056-2017, vigente desde el 03 de abril del 2017.
- Contrato N° 25-2017-FONDEPES.

Específicas:

- ✓ Artículo 34º de la Ley de Contrataciones y Adquisiciones del Estado.
- ✓ Artículo 169º del Reglamento de Contrataciones y Adquisiciones del Estado
- ✓ Artículo 170º del Reglamento de Contrataciones y Adquisiciones del Estado
- ✓ Artículo 171º del Reglamento de Contrataciones y Adquisiciones del Estado

3.2.- SUSTENTO DEL CONTRATISTA

El contratista CONSORCIO MARITIMO DEL NORTE, solicita la Ampliación de Plazo Parcial N° 14 por 75 días calendario, por la causal de "Cuando es necesario un plazo adicional para la ejecución de la prestación adicional de obra" y el cual manifiesta que requiere este plazo adicional para ejecutar la Prestación Adicional de Obra N° 06 correspondiente al expediente del Sistema de Utilización en Media Tensión 20 kv (Operación inicial en 10 kv), que fue aprobada mediante la Resolución Jefatural N° 158-2018-FONDEPES/J el 28 de diciembre del 2018, Indica que este expediente ha modificado la partida genérica de Instalaciones eléctricas 04.02 MEDIA TENSION del expediente técnico inicial; y que es necesario e imprescindible la aprobación del tiempo adicional para la ejecución de las partidas nuevas que se han generado para cumplir con los objetivos y las metas previstas en el proyecto. Menciona que la ejecución de la prestación adicional genera la afectación del plazo de ejecución de obra, por modificar la ruta crítica del programa de ejecución de obra vigente, ya que son partidas totalmente nuevas y diferentes al proyecto original y que afectan toda la partida genérica de las instalaciones eléctricas de la Media Tensión.

En el mismo sentido que el párrafo precedente; indica que la aprobación de la Prestación Adicional N° 06, modifica la especialidad de Instalaciones eléctricas del sistema de Media Tensión en el procedimiento constructivo en congruencia con los nuevos planos, presupuesto, metrados y especificaciones técnicas del adicional. Las partidas nuevas de la Prestación Adicional N° 06; si bien, estas partidas inicialmente no se encuentran dentro de la ruta crítica, al no poder ser ejecutadas debido a la no aprobación y aprobación del adicional correspondiente, estas partidas se convierten en partidas críticas que marcan el desarrollo total de la ejecución de la obra. Añade, que todas las partidas del adicional son de ejecución prioritaria y forman parte de la nueva ruta crítica del proyecto de acuerdo a la programación de obra vigente y que por situaciones ajenas a la voluntad del contratista no se han podido ejecutar hasta no aprobarse la modificación del proyecto, que reconoce la Entidad con la aprobación de la prestación Adicional de Obra N° 06 mediante la Resolución Jefatural N° 158-2018-FONDEPES/J el 28 de diciembre del 2018.

Página 8 de 15



"Decenio de la Igualdad de Oportunidades para Mujeres y Hombres"

000230

Como sustento de la cuantificación de la solicitud de ampliación de Plazo N° 14, el contratista manifiesta que el análisis se efectúa de acuerdo a la fecha de aprobación de la Prestación Adicional N° 06 y el respectivo cronograma de ejecución del mencionado adicional que forma parte del expediente; conectándolo en el programa de ejecución GANTT vigente a partir del día siguiente de la comunicación de la aprobación del adicional (Carta N° 465-2018-FONDEPES/SG del 28.12.2018) que en nuestro caso es el 29.12.2018 y como resultado de procesamiento de datos en el programa de obra vigente se obtiene un total de 543 días calendario que restándole el plazo contractual vigente de 467 días calendario, se obtiene un plazo adicional para la ejecución de 75 días calendario y tomando en cuenta que el plazo vence el 30.12.2018 al incrementarse el plazo obtenido, la fecha de término se traslada al 15.03.2019.

Indica también que con la emisión de la Resolución Jefatural N° 158-2018-FONDEPES/J el 28 de diciembre del 2018 que aprueba el expediente de la Prestación Adicional N° 06, el que fue notificada con Carta N° 465-2018-FONDEPES/SG fecha 28.12.2018; se da por concluida la causal de afectación del programa de obra vigente y deja constancia de este acto en el Asiento N° 654 del Contratista de fecha 28.12.2018, precisando que constituye un acto único para el inicio y cese de la causal de la ampliación de plazo.

DESCRIPCIÓN DE LA CAUSAL	INICIO/FIN DE LA CAUSAL	CUANTIFICACIÓN
Ejecución de las partidas de la Prestación Adicional de Obra N° 06 del Sistema Eléctrico de Media Tensión, aprobada con Resolución Jefatural N° 158-2018-FONDEPES/J.	<p>INICIO DE LA CAUSAL: 29 DE DICIEMBRE DEL 2018 Asiento N° 654 del C.O. (Notificación de la Resolución Jefatural N° 158-2018-FONDEPES/J)</p> <hr/> <p>CESE DE LA CAUSAL: 29 DE DICIEMBRE DEL 2018 Asiento N° 654 del C.O.</p>	75 DÍAS CALENDARIO

Gráfico N° 01: Cuantificación según contratista de la Ampliación de Plazo N° 14

En conclusión, el contratista CONSORCIO MARITIMO DEL NORTE, solicita por ser necesario para alcanzar la finalidad del contrato, la aprobación de la Ampliación de Plazo N° 14 por 75 días calendario para ejecutar la Prestación Adicional de Obra N° 06 correspondiente al expediente del Sistema de Utilización en Media Tensión 20 kv (Operación inicial en 10 kv), que fue aprobada mediante la Resolución Jefatural N° 158-2018-FONDEPES/J el 28 de diciembre del 2018; y considera que la misma se enmarca en el artículo 169° del Reglamento de la Ley de Contrataciones del Estado, ítem 2 que establece que una ampliación de plazo procede: "Cuando es necesario un plazo adicional para la ejecución de la prestación adicional de obra".

3.3.- ANALISIS Y EVALUACION DE LA SOLICITUD DE AMPLIACION DE PLAZO N° 14:

Para que proceda una ampliación de plazo, según el Reglamento de la Ley de Contrataciones del Estado debe cumplirse las siguientes condiciones:



a) Cumplimiento del Procedimiento según el Artículo 170º.

1º *El contratista por Intermedio de su Residente, deberá anotar en el Cuaderno de Obra, el inicio y el final de las circunstancias que a su criterio ameriten ampliación de plazo.*

Verificación del cumplimiento:

En cuaderno de obra, con Asiento N° 654 de fecha de 28 de diciembre del 2018 (inicio de la causal), el contratista deja constancia que ha recibido la Resolución Jefatural N° 158-2018-FONDEPES/J remitida con Carta N° 465-2018-FONDEPES/SG del 28.12.2018, mediante el cual notifican la aprobación del Expediente Técnico del Presupuesto Adicional de Obra N° 06, con el cual se fija el inicio de la causal de la ampliación de plazo N° 14. Del mismo modo en el mismo Asiento 654 de fecha 28 de diciembre del 2018 (término de la causal), el residente indica que la recepción de la Resolución Jefatural N° 158-2018-FONDEPES/J, constituye el acto único para el inicio y cese de la causal de ampliación de plazo N° 14 para la ejecución de la prestación Adicional de Obra N° 06.

Análisis:

Se verifica que el residente de obra ha cumplido con el procedimiento establecido cumplió al anotar con Asiento N° 654, en el cuaderno de obra del inicio y el final de las circunstancias que a su criterio ameritan una ampliación de plazo.

2º *Dentro de los quince (15) días siguientes de concluido la circunstancia invocada, el contratista o su representante legal solicita, cuantifica y sustenta su solicitud de ampliación de plazo ante el Inspector o Supervisor, según corresponda, siempre que la demora afecte la ruta crítica del programa de ejecución de obra vigente.*

Verificación del cumplimiento:

El contratista debe solicitar, cuantificar y sustentar la ampliación de plazo N° 14 ante el supervisor dentro de los quince (15) días de concluido la circunstancia invocada; se observa que la conclusión de la circunstancia invocada se da el 28 de diciembre del 2018 con Asiento N° 654 del residente en cuaderno de obra y tiene como fecha límite de sustentación de la ampliación de plazo el día 12 de enero del 2019. La solicitud de ampliación de plazo fue presentada por el representante legal del Contratista Consorcio Marítimo del Norte a la Supervisión el día 29 de diciembre del 2018 con Carta C204-2018-CMN-SUPE.

Análisis:

El contratista ha cumplido con el procedimiento al remitir a la supervisión la solicitud de la Ampliación de Plazo N° 14 con el sustento y la cuantificación dentro de los 15 días que establece el ítem 170.1 (segundo párrafo) del artículo 170º del Reglamento de la Ley de Contrataciones del Estado.

b) Identificación de la causal y afectación a la ruta crítica según Artículo 169º.

Al respecto el artículo 34º de la Ley de Contrataciones del Estado, en ítem 34.5 indica: "El



"Decenio de la Igualdad de Oportunidades para Mujeres y Hombres"

000233

contratista puede solicitar la ampliación de plazo pactado por atrasos o paralizaciones ajenas a su voluntad debidamente comprobados y que modifiquen el plazo contractual de acuerdo a lo que establezca el reglamento".

En el mismo sentido, el artículo 169° del Reglamento de Ley de Contrataciones del Estado indica: *"El contratista puede solicitar la ampliación de plazo pactado por cualquiera de las siguientes causales ajenas a su voluntad, siempre que modifiquen la ruta crítica del programa de ejecución de obra vigente al momento de la solicitud de ampliación:*

1. *Atrasos y/o paralizaciones por causas no atribuibles al contratista.*
2. *Cuando es necesario un plazo adicional para la ejecución de la prestación adicional de obra. En ese caso, el contratista amplía el plazo de las garantías que hubiere otorgado.*
3. *Cuando es necesario un plazo adicional para la ejecución de los mayores metrados que no provengan de variaciones del expediente técnico de obra, en contratos a precios unitarios".*

El contratista CONSORCIO MARITIMO DEL NORTE, solicita la Ampliación de Plazo N° 14 por 75 días calendario, argumentando que requiere un plazo adicional por la causal: "Cuando es necesario un plazo adicional para la ejecución de la prestación adicional de obra" y el cual según el contratista este plazo es necesario para la ejecución del Adicional de Obra N° 06 que corresponde a las partidas del Sistema Eléctrico de la Media Tensión del DPA de Supe, expediente que fue aprobado por Resolución Jefatural N° 158-2018-FONDEPES/J el 28 de diciembre del 2018; justifica el mayor plazo solicitado porque la ejecución del mencionado adicional genera la afectación del plazo de ejecución contractual al modificar la Ruta Crítica del programa de ejecución vigente a partir del 29.12.2018 y en el marco del artículo 169° del RLCE, le correspondería una ampliación de plazo por la causal: "Cuando es necesario un plazo adicional para la ejecución de la prestación adicional de obra".

Análisis:

Identificación de la Causal.

El contratista manifiesta que es necesario un plazo adicional de 75 días calendario por aprobación de la Prestación Adicional de Obra N° 06, específicamente para ejecutar las partidas del expediente técnico del sistema eléctrico de MEDIA TENSION, en razón de que a partir del día siguiente de la notificación (28.12.2018), modifica la ruta crítica del programa de obra vigente y considera que le correspondería una ampliación de plazo por la causal: "Cuando es necesario un plazo adicional para la ejecución de la prestación adicional de obra"; causal y argumento que consideramos válida y que se justifica de acuerdo a los fundamentos expuestos por el contratista Consorcio Marítimo del Norte.

En conclusión, la causal por "Cuando es necesario un plazo adicional para la ejecución de la prestación adicional de obra" es aplicable y es sustento válido; porque la ampliación solicitada es necesario para la ejecución de la Prestación Adicional N° 06; por lo tanto, consideramos que la solicitud del contratista está motivada.



"Decenio de la Igualdad de Oportunidades para Mujeres y Hombres"

000032

Afectación a la Ruta crítica

El contratista Consorcio Marítimo del Norte, en su solicitud de Ampliación de Plazo N° 14 argumenta que es necesario un plazo adicional para ejecutar las partidas de la Prestación Adicional N° 06, porque ha afectado la ruta crítica del programa de obra GANTT vigente en 75 días calendario, plazo que requiere para ejecutar las partidas del sistema eléctrico de la MEDIA TENSION; manifiesta que esto es ajena a su voluntad y en el marco del artículo 169° del RLCE, le corresponde una ampliación de plazo.

Análisis:

El expediente de la Prestación Adicional de obra N° 06 aprobada mediante Resolución Jefatural N° 158-2018-FONDEPES/J, adjunta dentro de los anexos un cronograma de ejecución de la mencionada prestación por 77 días calendario según se observa en el siguiente detalle:



Gráfico 1: Cronograma de ejecución de la Prestación Adicional de Obra N° 06, que determina su ejecución en 77 días calendario.



www.fondepes.gob.pe
LUIS ALBERTO TELLO HIDALGO
 INGENIERO CIVIL
 Reg. CIP N° 39250

"Decento de la Igualdad de Oportunidades para Mujeres y Hombres"

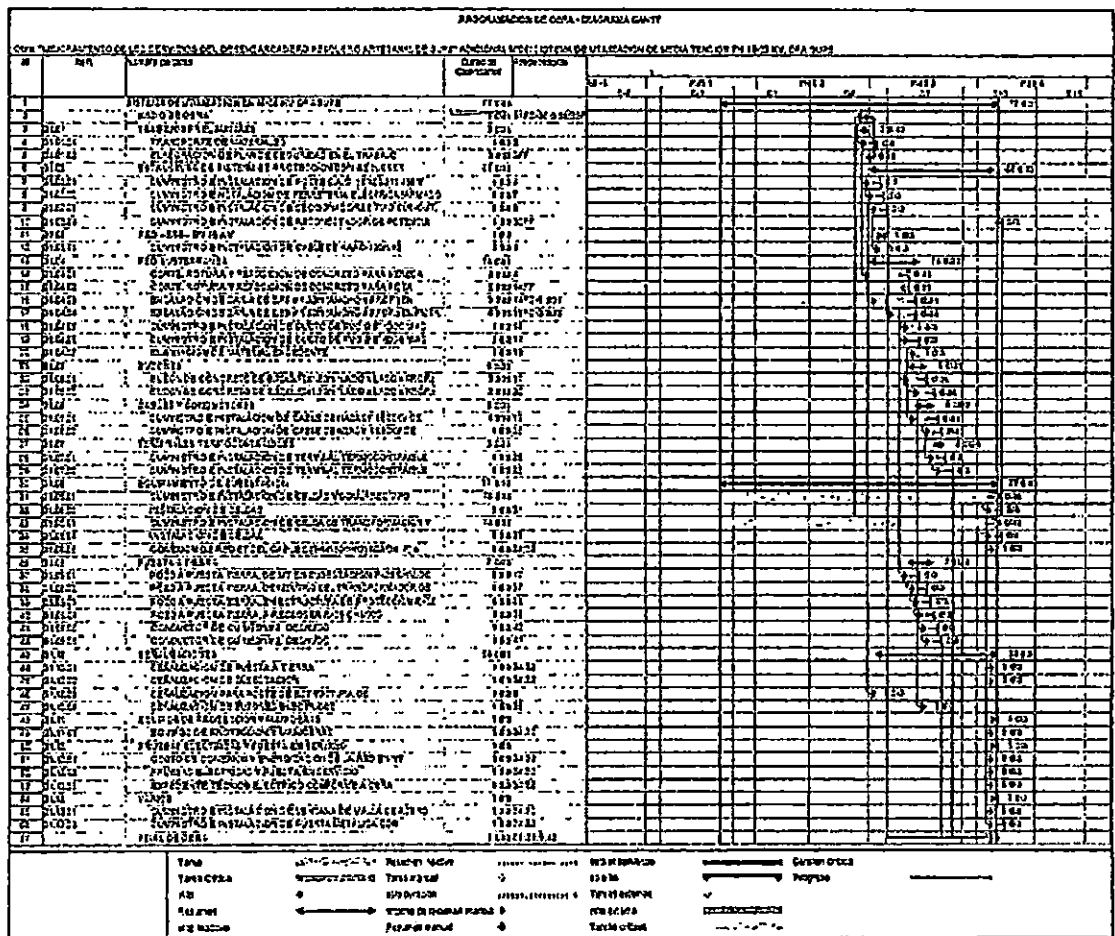
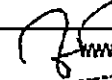
Ahora bien, ingresando las partidas del cronograma del sistema eléctrico de media tensión de la Prestación Adicional de Obra N° 06, en el programa de obra GANTT vigente a partir del 29.12.2018 (Al día siguiente de la notificación de la Resolución Jefatural N° 158-2018-FONDEPES/J al contratista Consorcio Marítimo del Norte), se observa:

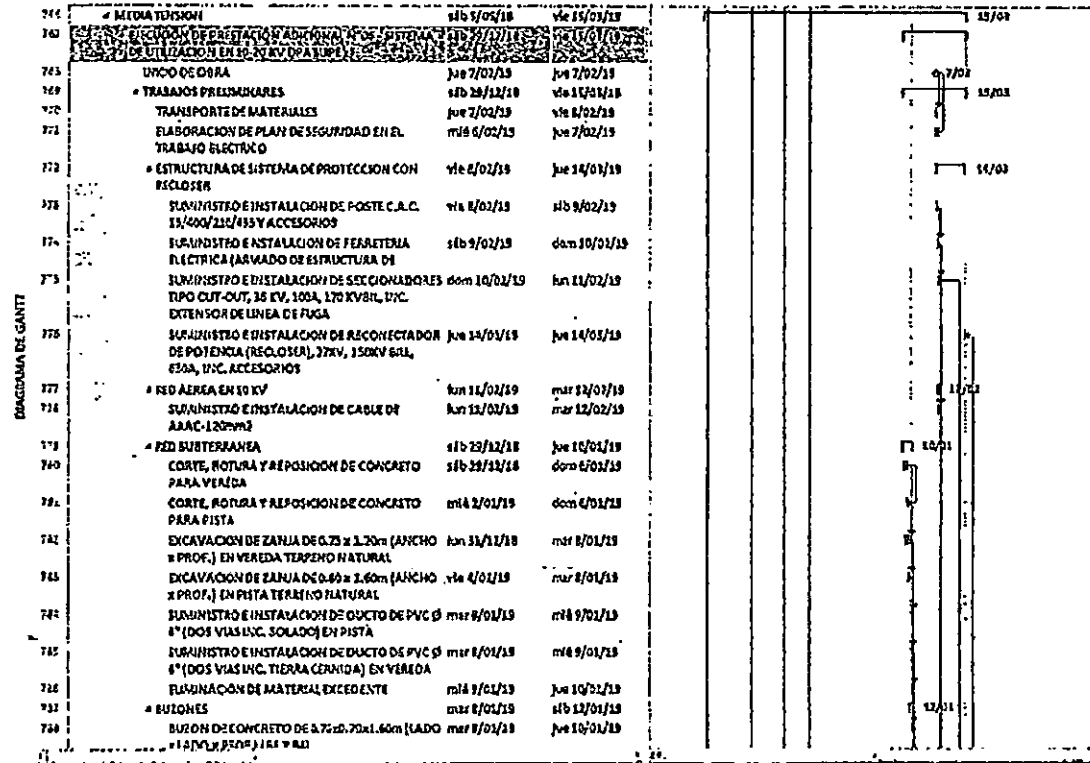

Se observa en el calendario GANTT donde se ha insertado las partidas del sistema eléctrico de media tensión del Adicional de Obra N° 06, se han visto partidas críticas y desplazan la programación hasta el día 15 de marzo del 2019; por lo tanto, los días necesarios para culminar la obra será:

- Fecha de término contractual: 30 de diciembre del 2018
- Fecha de término con el adicional de Obra N° 06: 15 de marzo del 2019.
- Número de días de ampliación: 75 días calendario

En conclusión, en concordancia con el programa de obra GANTT considerando la ejecución de las partidas del Adicional de Obra N° 06, desplaza la fecha de culminación de la obra hasta el 15.03.2019 afectando el plazo y consecuentemente el programa de obra vigente; por lo que esta condición se ampara en el Artículo 169° del Reglamento de la Ley de Contrataciones del Estado que establece:

"Procede la ampliación de plazo en los siguientes casos:



"Decenio de la Igualdad de Oportunidades para Mujeres y Hombres"

2.- Cuando es necesario un plazo adicional para la ejecución de la prestación adicional de la obra, siempre y cuando afecte el plazo. En ese caso el contratista amplía el plazo de las garantías que hubiese otorgado. (...). (El subrayado es agregado).

Por lo tanto, consideramos que la causal que invoca el contratista para solicitar la Ampliación de Plazo N° 14, se cumple y procede una ampliación del plazo por 75 días calendario para la ejecución del adicional de obra N° 06.

000230

3.4.-OPINION DE LA SUPERVISION

La supervisión CESEL SA, mediante Carta CSL.174302.PU.DPA.S.251.18 e Informe Especial N° CSL.174302.PU.IN.ESP.46 de fecha 07 de enero del 2018, opina que la solicitud de Ampliación de Plazo N° 14 solicitada por el contratista CONSORCIO MARITIMO DEL NORTE, debe ser declarada procedente debiéndose aprobar y sustenta su opinión según los siguientes motivos:

- La causal se produce con la aprobación del expediente técnico de la prestación adicional N° 06 efectuada mediante Resolución Jefatural N° 158-2018-FONDEPES/J que corresponden al "Sistema de Utilización en 20 kv (operación Inicial en 10 kv)" para la obra de Mejoramiento de los Servicios del Desembarcadero Pesquero Artesanal de Supe, cuya ejecución demanda un plazo que trae como consecuencia la modificación de la ruta crítica vigente y es ajena a la voluntad del contratista.
- Al insertar en el cronograma vigente las partidas del cronograma de ejecución de la prestación adicional N° 06, que tiene una duración de 77 días calendario y que se inicia el 29.12.2018, se observa que culmina el 15.03.2019, de donde se obtiene que es necesario 75 días calendario de ampliación de plazo.
- La causal invocada afecta la ruta crítica del calendario vigente, y las partidas de la prestación adicional N° 06 constituyen una nueva ruta crítica cuyo inicio es el 29.12.2018 al 30.15.2019; por lo tanto, se cumple con los requisitos señalados en el RLCE.
- Concluye que corresponde conceder la Ampliación de Plazo N° 14 solicitada por el contratista Consorcio Marítimo del Norte por 75 días calendario.

Recomienda finalmente, emitir la resolución acorde con lo expuesto y se notifique dicha resolución al contratista en un plazo máximo de 10 días hábiles de recibido su Informe.

IV. CONCLUSIONES Y RECOMENDACIONES

4.1 CONCLUSIONES

- ✓ La supervisión de la obra CESEL SA, mediante Carta CSL.174302.PU.DPA.S.251.18 del 07 de enero del 2018 e Informe N° CSL.174302.PU.IN.ESP.46 adjunto, recomienda emitir la resolución declarando procedente la solicitud de Ampliación de Plazo N° 14 por 75 días calendario.
- ✓ De la evaluación efectuada al expediente de Ampliación de Plazo N° 14 por 75 días calendario, solicitada por el contratista CONSORCIO MARITIMO DEL NORTE para la ejecución del Adicional de Obra N° 06, aprobada con Resolución Jefatural N° 158-2018-FONDEPES/J del 28 de diciembre del 2018; se concluye que la ampliación del plazo PROCEDE por 75 días calendario, plazo necesario para alcanzar la finalidad del contrato y el cual se justifica por los trabajos que implica

Página 14 de 15



"Decenio de la Igualdad de Oportunidades para Mujeres y Hombres"

000229

la ejecución de la Prestación Adicional de Obra N° 06, que corresponden a las partidas del sistema eléctrico de la Media Tensión; según el análisis expuesto en el presente Informe y conforme al Reglamento de la Ley de Contrataciones del Estado y del Contrato.

- ✓ En concordancia con el párrafo precedente, la nueva fecha de término de la obra será el 15 de marzo del 2019.

4.1 RECOMENDACIONES

- ✓ De lo expuesto y en concordancia con el artículo 170° del Reglamento de la Ley de Contrataciones del Estado, se recomienda remitir notificación al contratista CONSORCIO MARITIMO DEL NORTE con copia a la supervisión CESELSA, sobre la procedencia de la solicitud de Ampliación de Plazo N° 14 por 75 días calendario, en una fecha no mayor al 21.01.2019.
- ✓ Es preciso recalcar, que una vez aprobado la Ampliación de Plazo N° 14, el contratista está en la obligación de ampliar el plazo de la garantía de fiel cumplimiento del contrato principal por los días otorgados.
- ✓ En el mismo sentido, en aplicación del ítem 171.3 del artículo 171° del Reglamento de la Ley de Contrataciones del Estado, la Entidad debe ampliar el plazo de los servicios de la supervisión por 75 días calendario, en virtud de la ampliación de plazo otorgada vinculado al contrato principal.

Es cuanto informo a Usted para su conocimiento y fines.

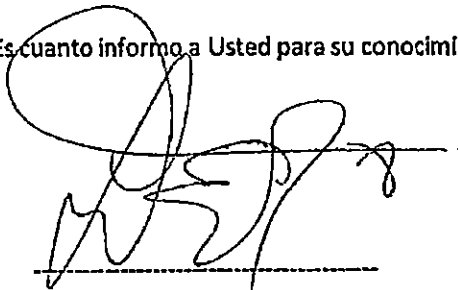

Ing. Luis Alberto Tello Hidalgo.
CIP N° 39250

El coordinador del Área de Obras que suscribe hace suyo el documento.

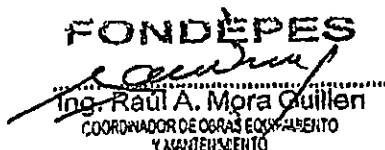

FONDEPES
Ing. Raúl A. Mora Guillen
COORDINADOR DE OBRAS EQUIPAMIENTO
Y MANTENIMIENTO

Página 15 de 15





CONSORCIO MARITIMO DEL NORTE

CONSORCIO MARÍTIMO DEL NORTE.

MEJORAMIENTO Y RECUPERACIÓN DE LOS SERVICIOS DEL
DESEMBARCADERO PESQUERO ARTESANAL DE SUPE, DISTRITO DE SUPE
PUERTO, PROVINCIA DE BARRANCA, REGIÓN LIMA

Tipo de Documento	N°	Mes	Fecha
Valorización	18	Febrero	28/02/2019

INFORME MENSUAL

000000

VALORIZACIÓN N°18



CONSORCIO MARITIMO DEL NORTE

FEBRERO

2018

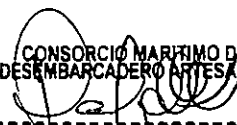
CONSORCIO MARITIMO DEL NORTE
DESEMBARCADERO ARTESANAL DE SUPE

DANIEL JOAQUIN MORALES VIVANCO
RESIDENTE DE OBRA
REG. CIP N° 98098



CONSORCIO MARITIMO DEL NORTE

CONSORCIO MARÍTIMO DEL NORTE

MEJORAMIENTO Y RECUPERACIÓN DE LOS SERVICIOS DEL
DESEMBARCADERO PESQUERO ARTESANAL DE SUPE, DISTRITO DE SUPE
PUERTO, PROVINCIA DE BARRANCA, REGIÓN LIMA

Tipo de Documento	N°	Mes	Fecha
Valorización	18	Febrero	28/02/2019

CONTENIDO

000220

- I. GENERALIDADES
 - 1.1 Antecedentes
 - 1.2 Datos generales de obra
- II. CONTROL DE AVANCE
 - 2.1 Descripción
 - 2.2 Estatus de permisos y licencias
 - 2.3 Avance físico de obra
- III. CRONOGRAMA DE AVANCE (COMPARACIÓN DE LO PROGRAMADO Y LO EJECUTADO HASTA LA FECHA)
- IV. CONTROL DE CALENDARIO DE ADQUISICIÓN DE MATERIALES
- V. CONTROL DE CALIDAD DE MATERIALES
 - 5.1 Certificados CONCRETO, ACERO, ETC
 - 5.2 Control de vaciados
- VI. CONTROL DE EQUIPOS
- VII. CONTROL Y PREVENCIÓN DE RIESGOS (SEGURIDAD)
- VIII. CONTROL AMBIENTAL INFORME DE LAS ACTIVIDADES REALIZADAS DURANTE EL MES.
- IX. CONTROL ECONÓMICO
 - 9.1 Adelantos
 - 9.2 Carta Fianza
 - 9.3 Pólizas de seguro vigentes
- X. CAMBIOS Y/O MODIFICACIONES DEL PROYECTO ORIGINAL
- XI. COPIA DEL CERTIFICADO DE HABILIDAD VIGENTE DEL RESIDENTE

CONSORCIO MARITIMO DEL NORTE
DESEMBARCADERO ARTESANAL DE SUPE

DANIEL JOAQUÍN MORALES VIVANCO
RESIDENTE DE OBRA
REG. CIP N° 98098

 <p>CONSORCIO MARITIMO DEL NORTE</p>	CONSORCIO MARÍTIMO DEL NORTE		
	MEJORAMIENTO Y RECUPERACION DE LOS SERVICIOS DEL DESEMBARCADERO PESQUERO ARTESANAL DE SUPE, DISTRITO DE SUPE PUERTO, PROVINCIA DE BARRANCA, REGION LIMA		
	Tipo de Documento	N°	Mes
Valorización	18	Febrero	28/02/2019

000287

i. **GENERALIDADES**

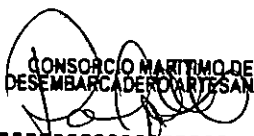
 CONSORCIO MARITIMO DEL NORTE
 DESEMBARCADERO ARTESANAL DE SUPE

DANIEL JOAQUIN MORALES VIVALCO
 RESIDENTE DE OBRA
 REG. CIP N° 98098



CONSORCIO MARÍTIMO DEL NORTE

MEJORAMIENTO Y RECUPERACIÓN DE LOS SERVICIOS DEL
DESEMBARCADERO PESQUERO ARTESANAL DE SUPE, DISTRITO DE SUPE
PUERTO, PROVINCIA DE BARRANCA, REGIÓN LIMA.

Tipo de Documento	N°	Mes	Fecha
Valorización	18	Febrero	28/02/2019

I. GENERALIDADES

000025

1.1 Antecedentes

Con fecha 24 de junio del 2017, se adjudicó la Licitación Pública N°001-2017, Primera convocatoria para la contratación de la ejecución de las obras por paquete:
"MEJORAMIENTO Y RECUPERACION DE LOS SERVICIOS DEL DESEMBARCADERO PESQUERO ARTESANAL DE SUPE, DISTRITO DE SUPE PUERTO, PROVINCIA DE BARRANCA, REGIÓN LIMA ".

1.2 Datos generales de obra

Licitación Pública : Licitación Pública N° 001-2017.

OBRA : "Mejoramiento y Recuperación de los Servicios del Desembarcadero Pesquero Artesanal de Supe, Distrito de Supe Puerto, Provincia de Barranca, Región Lima"

Ubicación : Distrito de Supe Puerto
Provincia de Barranca
Región Lima.

Entidad Contratante : FONDEPES.

Modalidad de Ejecución : A Precios Unitarios.

Contratista : Consorcio Marítimo del Norte

Residente de Obra : Ing. Daniel Morales Vivanco

Supervisor de Obra : Ing. Ludwing Carrasco Bustamante

Monto de la Obra : S/. 21,509,089.61 Inc. IGV.

Monto de Contrato : S/. 18,228,042.04 03 Sin IGV.

Plazo de Ejecución

CONSORCIO MARITIMO DEL NORTE
DESEMBARCADERO ARTESANAL DE SUPE

DANIEL JOAQUIN MORALES VIVANCO
RESIDENTE DE OBRA
REG. CIP N° 98098

**CONSORCIO MARÍTIMO DEL NORTE****MEJORAMIENTO Y RECUPERACIÓN DE LOS SERVICIOS DEL
DESEMBARCADERO PESQUERO ARTESANAL DE SUPE, DISTRITO DE SUPE
PUERTO, PROVINCIA DE BARRANCA, REGIÓN LIMA**

Tipo de Documento	N°	Mes	Fecha
Valorización	18	Febrero	28/02/2019

- Contractual : 270 días calendario.
- Entrega de Terreno : 06 de septiembre del 2017. 000223
- Fecha de inicio Del Plazo : 19 de septiembre de 2017.
- Fecha de Término
Del Plazo : 15 de junio de 2018.
- Ampliación de Plazo N° 01 : Denegada por la Entidad
- Ampliación de Plazo N° 02 : Denegada por la Entidad
- Adicional de Obra N° 01 : Aprobada mediante Resolución Jefatural N°
008-2018-FONDEPES/J por Modificación de la
partida 01.05 Enrocado de Protección y Terraplén
- Ampliación de Plazo N° 03 : Aprobada RSG Nro. 028-2018-
FONDEPES/SG (42 DIAS)
- Ampliación de Plazo N° 04 : Aprobada RSG Nro. 029-2018-
FONDEPES/SG (32 DIAS)
- Nueva Fecha de Término
Del Plazo : 28 de agosto de 2018.
- Adicional de Obra N° 02 : Aprobada mediante Resolución Jefatural N°
052-2018-FONDEPES/J por Modificación de
cimentación de la zona de edificios en Tierra.
- Ampliación de Plazo N° 05 : 28 días (Aprobada RSG N° 110-2018-
FONDEPES/SG)
- Ampliación de Plazo N° 06 : (Denegada RSG N° 111-2018-
FONDEPES/SG)
- Ampliación de Plazo N° 07 : (Denegada RSG N° 112-2018-
FONDEPES/SG)

CONSORCIO MARÍTIMO DEL NORTE
DESEMBARCADERO ARTESANAL DE SUPE
DANIEL JOAQUÍN MORALES VIVA YCO
RESIDENTE DE OBRA
REG. CP° N° 98098



CONSORCIO MARÍTIMO DEL NORTE

MEJORAMIENTO Y RECUPERACION DE LOS SERVICIOS DEL
DESEMBARCADERO PESQUERO ARTESANAL DE SUPE, DISTRITO DE SUPE
PUERTO, PROVINCIA DE BARRANCA, REGIÓN LIMA

Tipo de Documento	N°	Mes	Fecha
Valorización	18	Febrero	28/02/2019

000021

Adicional de Obra N° 03 : Aprobada mediante Resolución Jefatural N° 094-2018-FONDEPES/J por Modificación de Instalaciones Eléctricas.

Adicional de Obra N° 04 : Aprobada mediante Resolución Jefatural N° 095-2018-FONDEPES/J por Modificación de Instalaciones Sanitarias.

Ampliación de Plazo N° 08 : 52 días (Aprobada RSG N° 171-2018-FONDEPES/SG)

Ampliación de Plazo N° 09 : (Denegada RSG N° 172-2018-FONDEPES/SG)

Ampliación de Plazo N° 10 : 44 días (Aprobada SG N° 215-2018-FONDEPES S/G)

Ampliación de Plazo N° 11 : (Denegada RSG N°216 -2018-FONDEPES/GG)

Ampliación de Plazo N° 12 : (Denegada RSG N°217-2018-FONDEPES/GG)

Ampliación de Plazo N° 13 : (Denegada RSG N°012-2019-FONDEPES/GG)

Ampliación de Plazo N° 14 : 75 días (Aprobada RSG N°013-2019-FONDEPES/GG)

Nueva Fecha de Término
Del Plazo : 15 de marzo de 2019.

CONSORCIO MARITIMO DEL NORTE
DESEMBARCADERO ARTESANAL DE SUPE

DANIEL JOAQUIN MORALES VIVA NCO
RESIDENTE DE OBRA
REG. CIP N° 98098



CONSORCIO MARÍTIMO DEL NORTE

MEJORAMIENTO Y RECUPERACION DE LOS SERVICIOS DEL
DESEMBARCADERO PESQUERO ARTESANAL DE SUPE, DISTRITO DE SUPE
PUERTO, PROVINCIA DE BARRANCA, REGIÓN LIMA

Tipo de Documento	N°	Mes	Fecha
Valorización	18	Febrero	28/02/2019

000000

II. CONTROL DE AVANCE

CONSORCIO MARITIMO DEL NORTE
DESEMBARCADERO ARTESANAL DE SUPE

DANIEL JOAQUIN MORALES VIVANCO
RESIDENTE DE OBRA
REG. CIP N° 98098

	CONSORCIO MARÍTIMO DEL NORTE		
	MEJORAMIENTO Y RECUPERACION DE LOS SERVICIOS DEL DESEMBARCADERO PESQUERO ARTESANAL DE SUPE, DISTRITO DE SUPE PUERTO, PROVINCIA DE BARRANCA, REGIÓN LIMA		
Tipo de Documento	N°	Mes	Fecha
Valorización	18	Febrero	28/02/2019

000021

III. CONTROL DE AVANCE

3.1 Descripción

A la fecha se viene ejecutando las actividades programadas de acuerdo a nuestro Cronograma de actividades, el mismo que se viene cumpliendo llegando a un porcentaje de avance ejecutado de 54.19% a la fecha.



CONSORCIO MARITIMO DEL NORTE
DESEMBARCADERO ARTESANAL DE SUPE

DANIEL JOAQUIN MORALES VIVANCO
RESIDENTE DE OBRA
REG. CIP N° 98098

000217

ANEXO

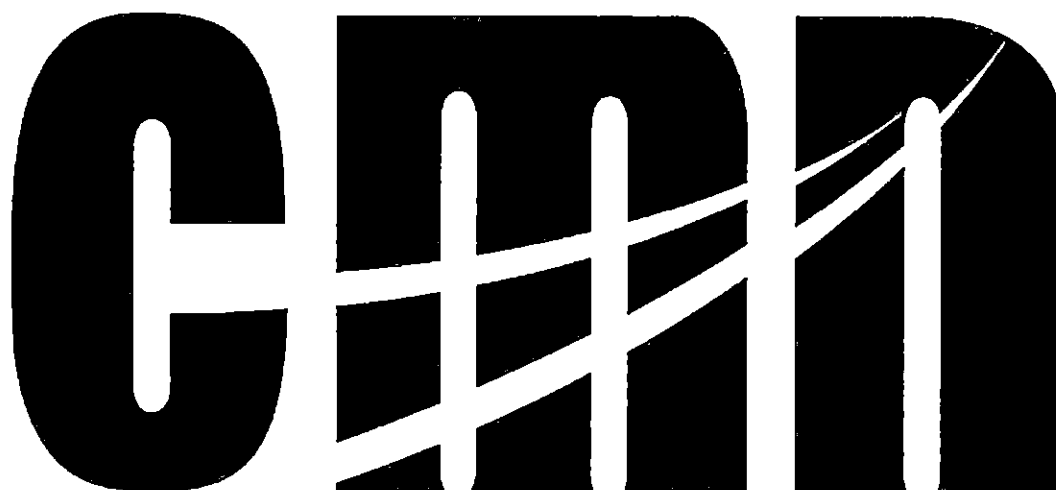
CONTROL DE CALIDAD



CONSORCIO MARITIMO DEL NORTE

"Mejoramiento y Recuperación de los servicios del Desembarcadero Pesquero Artesanal de Supe,
Distrito de Supe Puerto, Provincia de Barranca, Región Lima"

FEBRERO

2019

CONSORCIO MARITIMO DEL NORTE
DESEMBARCADERO ARTESANAL DE SUPE
DANIEL JOAQUIN MORALES VIVA YCO
RESIDENTE DE OBRA
REG. CIP N° 98098



PROYECTO:
**MEJORAMIENTO Y RECUPERACIÓN DE LOS SERVICIOS DEL
 DESEMBARCADERO PESQUERO ARTESANAL DE SUPE**

CC275-IVCI -CMN

Elemento:

MO 1
 000219

VACIADO DE CONCRETO EN MESA DE OVALIN

CONTRATISTA: CONSORCIO MARITIMO DEL NORTE		CLIENTE: FONDO NACIONAL DE DESARROLLO PESQUERO - FONDEPES	
FECHA DE VACIADO:		VOLUMEN A VACIAR: m3	
TIPO DE ESTRUCTURA: MESA Concreto Armado		REGISTRA PROBETAS: SI <input type="checkbox"/> NO <input checked="" type="checkbox"/>	
DOCUMENTOS DE REFERENCIA: REV. N°		OBSERVACIONES:	
		NEEDS Sociales 1° Nivel	
		35-HH VISIONES	
METODO DE VACIADO: SIN BOMBA		SLUMP: 4" - 6"	
Fc DISEÑO / CEMENTO tipo: 210 kg/cm2		TEMPERATURA: pulgadas °C	
TAM. MAX. AGREGADO: pulgadas		METODO DE CURADO: AGUA	
TIPO DE ACABADO: Regular			
CHECKLIST PREVIO AL VACIADO			
		CONTRATISTA	
		SUPERVISION	
	CHECK	FECHA	INICIALES / CHECK
Materiales Aprobados (diseños, embebidos, demoldantes, curadores, etc.)	/		
Cambios Aprobados (cambios o modificaciones en elementos a vaciar)	/		
Inspección Topográfica (alineamiento, nivelación, dimensiones, etc.)	/		
Encofrado	/		
Armadura de refuerzo	/		
Limpieza dentro de encofrado	/		
Elementos Embebidos Civiles (anclajes, marcos, etc.)	/		
Elementos Embeb. Mecánicos (pernos de anclajes, tuberías, etc.)	/		
Elementos Embebidos Eléctricos (conduit, red de tierra, etc.)	/		
Elementos Embeb. Sistem. Esp. (conduit, red de tierra, etc.)	/		
Inspección Topográfica de elementos embebidos (alineamiento, nivelación, dimensiones, etc.)	/		
Equipos menores en buen estado (reglas vibratorias, vibradoras de aguja, etc.)	/		
Stock de Materiales (curador, lamina polietileno, vigas tipo puente, mantas de yute, reglas, etc.)	/		
Otro (especificar):			
PRE-VACIADO VERIFICADO POR		SUPERVISION	
NOMBRE:			
FIRMA:			
Ing. Residente - Contratista			
VO B° / Aprobación			
CHECKLIST POSTERIOR AL VACIADO			
		CHECK	FECHA
Inspección Topográfica de elementos vaciados (alineamiento, nivelación, dimensiones, etc.)			
Inspección Topográfica de elementos embebidos (alineamiento, nivelación, dimensiones, etc.)			
Buen acabado en el concreto fresco después de colocado.			
Curado adecuado.			
CONFORME CON REPARACIÓN:		Especificar proceso de reparación:	
SI <input type="checkbox"/> NO <input type="checkbox"/> NO APLICA <input type="checkbox"/>			
* Curar con agua por 7 días.			
COMENTARIOS:			
Responsable de Campo		Control de Calidad	
Sello y Firma: Ing. Luis M. Vera Castañeda INGENIERO CIVIL REG. CIP 140228		Sello y Firma: GIL GILBERTO GALINDO VEGA CONTROL DE CALIDAD CONSORCIO MARITIMO DEL NORTE	
Residente De Obra		Supervisor de Obra	
Sello y Firma: CONSORCIO MARITIMO DEL NORTE DESEMBARCADERO PESQUERO ARTESANAL DE SUPE		Sello y Firma: LUDWIG CARRASCO BUSTAMANTE Ing. Supervisor - CIP 79040 CESEL S.A.	



INSPECCION DE ACERO DE REFUERZO

CC275-IAR/ -CMN

CLIENTE:	FONDO NACIONAL DE DESARROLLO PESQUERO - FONDEPES	REGISTRO:	000000
CONTRATISTA:	CONSORCIO MARÍTIMO DEL NORTE		
OBRA:	MEJORAMIENTO Y RECUPERACIÓN DE LOS SERVICIOS DEL DESEMBARCADERO PESQUERO ARTESANAL DE SUPE	FECHA:	05/02/19

UBICACION:	SS. HH. VORONES	DOCUMENTOS DE REFERENCIA:	
SECTOR:	ZONA DE LOS BOQUES		
T. ESTRUCTURA:			

ESQUEMA DE LA ARMADURA: Graficar el elemento, identificar ubicación por ejes, puntualizar detalles del acero.

SE ADJUNTA DETALLE X1

CHECKLIST DEL ACERO DE REFUERZO

	CONFORME	NO CONFORME	NO APLICA	REPARADO/CORREGIDO	COMENTARIOS
Limpieza (corrosión, concreto, grasa)	/				
Calidad del acero (Norma ASTM, grado, marca)	/				
Diámetro de varilla	/				
Longitud de traspape	/				
Longitud de gancho	/				
espaciamento entre barras	/				
espaciamento de estribos	/				
Alambre de amarre	/				
Soportes para recubrimiento contra base	/				
Soportes para recubrimiento lateral	/				
Verticalidad (plomada)	/				
Horizontalidad (nivel)	/				

COMENTARIOS / OBSERVACIONES GENERALES:

Responsable de Campo:	Sello y Firma: Ing. Luis M. Vera Castañeda INGENIERO CIVIL REG. CIP 140228	Control de Calidad:	Sello y Firma: BRAYAN GALINDO VEGA CONTROL DE CALIDAD CONSORCIO MARITIMO DEL NORTE
Residente de Obra:	Sello y Firma: DANIEL QUIROZ INGENIERO CIVIL REG. CIP 10000	Supervisor de Obra:	Sello y Firma: LUDWING CARRASCO BUSTAMANTE Ing. Supervisor - CIP 79040 CESEL S.A. 12/02/19

Se andó las
barras a la
columna existente.

Se andó las
barras a las
columnas, uso de andaje.
1Ø3/8" genérico.

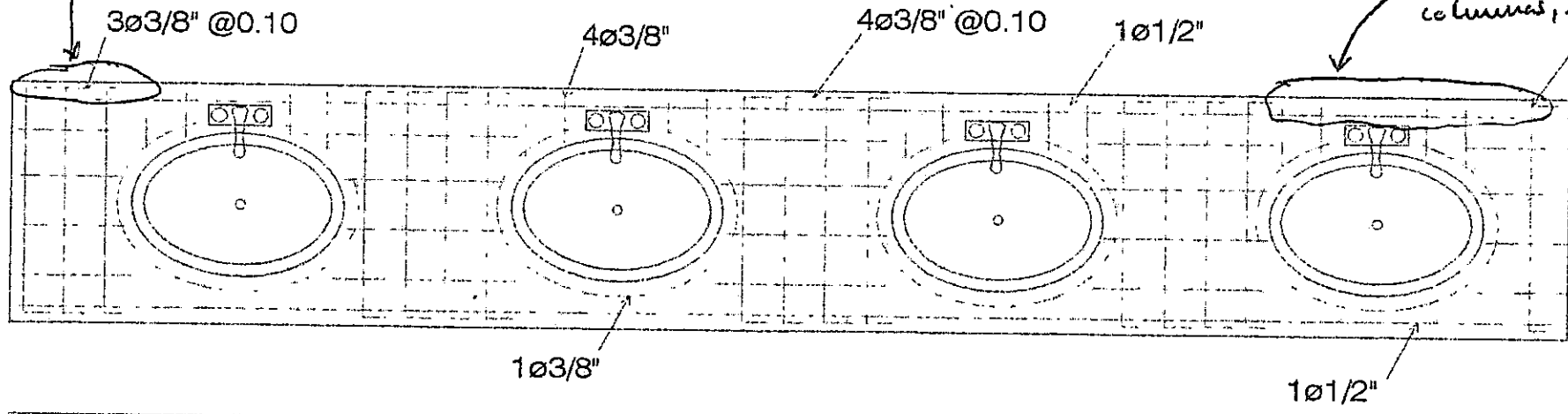

Estructura H= 0.085 m
Arquitectura H= 0.10 m

Estructura H= 0.885 m
Arquitectura H= 0.90 m

8Ø3/8" @0.10

5Ø3/8" @0.10

Andaje
Químico

Ing. Luis M. Carrasco
INGENIERO CIVIL
REG. CIP 140729

3.75 m

12cm

DETALLE X1

[Signature]
REC. CIP N. 95000

[Signature]
GRUPO CALINCO Y CIA
CONTROL DE CALIDAD
CONSORCIO MARITIMO DEL NORTE

[Signature]
EDUING CARRASCO
Ing. Supervisor
CESI
12/02/19

000000
12/02/19



PROYECTO: MEJORAMIENTO Y RECUPERACIÓN DE LOS SERVICIOS DEL DESEMBARCADERO PESQUERO ARTESANAL DE SUPE

CC275-HECTC/ -CMN
REGISTRO:

INSPECCION DE ENCOFRADO

Contratista:	CONSORCIO MARITIMO DEL NORTE	Fecha:	06/02/19. 003216
Cliente:	FONDO NACIONAL DE DESARROLLO PESQUERO - FONDEPES	Documentos de referencia:	
Ubicación:	Zona áreas Sociales (S.S.HH Valonis).		
Tipo de estructura:	Mesa de Concreto Armado		

ESQUEMA DEL ENCOFRADO:

Graficar el elemento, identificar ubicación por ejes, puntualizar detalles del encofrado

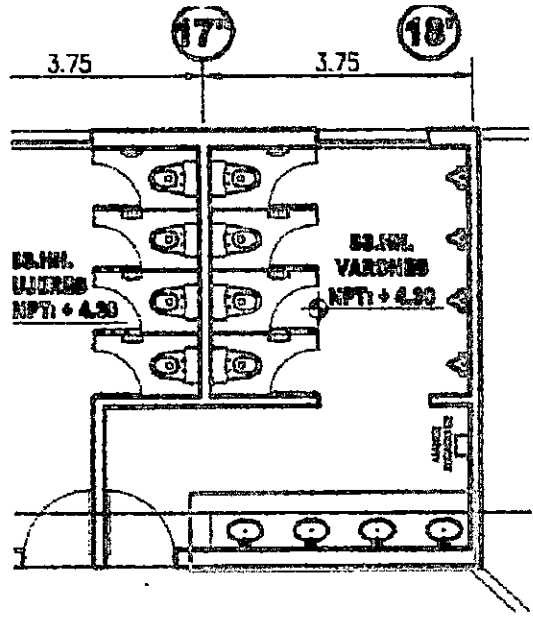

DATOS DIMENSIONALES (mm):

PUNTOS PLOMADA																				
ARRIBA																				
ABAJO																				
DESVIACION																				

CHECKLIST DEL ENCOFRADO:

	CONFORME	NO CONFORME	NO APLICA	REPARADO/CO RREGIDO	COMENTARIOS
Material del encofrado	/				
Condición del encofrado	/				
Protección de formas del encofrado	/				
Forma y dimensiones del encofrado	/				
Aplicación de desmoldante	/				
Aseguramiento de soleras	/				
Apuntalamiento y fijación	/				
Hermeticidad del encofrado	/				
Fecha de desencofrado	/				

COMENTARIOS / OBSERVACIONES GENERALES:

Responsable de Campo:	Sello y Firma: Ing. Luis M. Vera Castañer INGENIERO CIVIL REG. CIP 140228	Control de Calidad:	Sello y Firma: CRISTIAN GALINDO VEGA CONTROL DE CALIDAD CONSORCIO MARITIMO DEL NORTE
Residente de Obra:	Sello y Firma: CONSORCIO MARITIMO DEL NORTE DESEMARCADERO PESQUERO ARTESANAL DE SUPE LUDWING CARRASCO BUSTAMANTE REG. CIP N° 140228	Supervisor de Obra:	Sello y Firma: LUDWING CARRASCO BUSTAMANTE Ing. Supervisor - CIP 71140 CESEL S.A. 12/04/19

Página

Descripción

Acero Fy= 4200kg/cm²

MESA OVALIN - ADMINISTRACIÓN
S/HH. VARONES

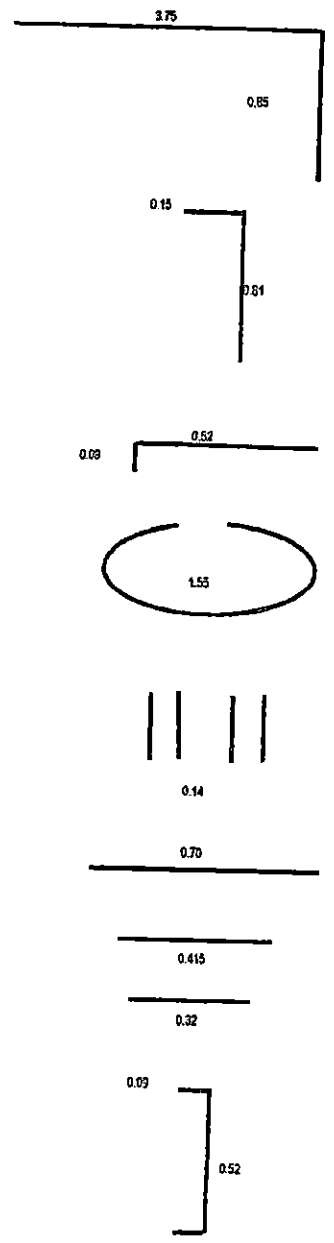

Ø	N° Varones	Cant. Elem	Long. elem	CANT. PISOS	Acero Fy= 4200kg/cm ²				Total Kg		
					1/2"	3/8"	1/2"	5/8"			
					0.75	0.58	0.99	1.55	2.24	3.97	51
1/2"	1.00	2	4.600	1.00			0.14				9.14
3/8"	1.00	5	0.96	1.00		2.69					2.69
3/8"	1.00	8	0.61	1.00		2.73					2.73
3/2"	1.00	4	1.55	1.00		3.47					3.47
3/8"	4.00	4	0.14	1.00		1.25					1.25
3/8"	4.00	1	0.70	1.00		1.57					1.57
3/8"	4.00	2	0.42	1.00		1.88					1.88
3/8"	4.00	1	0.32	1.00		0.72					0.72
3/8"	1.00	15	0.70	1.00		5.88					5.88
TOTAL ACERO (KG)											28.32

CONSEJO DE ADMINISTRACIÓN
 DE LA EMPRESA
 DA
 R.L.B. C.P. 4 00050

Ludwing Ferrasco Bustamante
 LUDWING FERRASCO BUSTAMANTE
 Ing. Supervisor - CIP 79040
 CESEL S.A.
 12/02/2019



PROYECTO: **MEJORAMIENTO Y RECUPERACIÓN DE LOS SERVICIOS DEL DESEMBARCADERO PESQUERO ARTESANAL DE SUPE**

CC275-IVC/ -CMN
Elemento: 000214

INSPECCIÓN DE VACIADO DE CONCRETO

CONTRATISTA: CONSORCIO MARITIMO DEL NORTE		CLIENTE: FONDO NACIONAL DE DESARROLLO PESQUERO - FONDEFES			
FECHA DE VACIADO:		VOLUMEN A VACIAR:			
TIPO DE ESTRUCTURA: caja registro		REGISTRA PROMETAS: SI <input type="checkbox"/> NO <input type="checkbox"/> m3			
DOCUMENTOS DE REFERENCIA:		OBSERVACIONES:			
REV. N°		GRUPO:			
METODO DE VACIADO: SIN BOMBA					
Pc DISEÑO / CEMENTO tipo: 350		SLUMP: 4" - 6"			
TAM. MAX. AGREGADO:		TEMPERATURA:			
TIPO DE ACABADO:		METODO DE CURADO: AGUA			
CHECKLIST PREVIO AL VACIADO					
	CONTRATISTA		SUPERVISION		
	CHECK	FECHA	INICIALES / CHECK	FECHA	
Materiales Aprobados (diseños, embebidos, demoldantes, curadores, etc.)	/				
Cambios Aprobados (cambios o modificaciones en elementos a vaciar)	/				
Inspección Topográfica (alineamiento, nivelación, dimensiones, etc.)	/				
Encofrado	/				
Armadura de refuerzo	/				
Limpeza dentro de encofrado	/				
Elementos Embebidos Civiles (anclajes, marcos, etc.)	/				
Elementos Embeb. Mecánicos (pernos de anclajes, tuberías, etc.)	/				
Elementos Embebidos Eléctricos (conduit, red de tierra, etc.)	/				
Elementos Embeb. Sistem. Esp. (conduit, red de tierra, etc.)	/				
Inspección Topográfica de elementos embebidos (alineamiento, nivelación, dimensiones, etc.)	/				
Equipos menores en buen estado (reglas vibratorias, vibradoras de aguja, etc.)	/				
Stock de Materiales (curador, lamina polietileno, vigas tipo puente, mantas de yute, reglas, etc.)	/				
Otro (especificar):					
PRE-VACIADO VERIFICADO POR		NOMBRE:		SUPERVISION	
		FIRMA:			
Ing. Residente - Contratista					
Vº Bº / Aprobación					
CHECKLIST POSTERIOR AL VACIADO					
Inspección Topográfica de elementos vaciados (alineamiento, nivelación, dimensiones, etc.)		CHECK	FECHA	CHECK	FECHA
Inspección Topográfica de elementos embebidos (alineamiento, nivelación, dimensiones, etc.)					
Buen acabado en el concreto fresco después de colocado.					
Curado adecuado.					
CONFORME CON REPARACIÓN:		Especificar proceso de reparación:			
SI <input type="checkbox"/> NO <input type="checkbox"/> NO APLICA <input type="checkbox"/>					
COMENTARIOS:					
El curado se hizo en al menos por 7 días de manera permanente o utilizar curador químico.					
Responsable de Campo	Señó y Firma: Ing. Luis M. Vera Castañeda INGENIERO CIVIL REG. CIP 111702		Control de Calidad	Señó y Firma: 19.01.18 BRAYAN CALINDO VEGA CONTROL DE CALIDAD CONSORCIO MARITIMO DEL NORTE	
Residente de Obra	Señó y Firma: CONSORCIO MARITIMO DEL NORTE DESEMBARCADERO PESQUERO ARTESANAL DE SUPE DANIEL JOAQUIN MORALES VIVI RESIDENTE DE OBRA REG. CIP N° 90092		Supervisor de Obra	Señó y Firma: ING. PEDRO MUCHA CESEL S.A. SUPERVISOR DE OBRA 19.01.19	



CONTROL DE CALIDAD

INSPECCION DE TARRAJEOS Y DERRAMES

NOMBRE DEL PROYECTO: MEJORAMIENTO Y RECUPERACIÓN DE LOS SERVICIOS DEL DESEMBARCADERO PESQUERO ARTESANAL DE BUPE
 CLIENTE: FONDO NACIONAL DE DESARROLLO PESQUERO - FONDEPES
 CONTRATISTA: CONSORCIO MARITIMO DEL NORTE
 FECHA: 26/02/19
 AREA: SECTOR:

Verificaciones Generales:

Limpieza Rugosidad Humedad

Ambiente / Eje	Alineamiento de muros		Verticalidad de muros		Uniformidad de muros		Taraqueo Columnado de Muro		Encuentro cielo raso-muro tipo Media Caña		Verticalidad de derrame		Contrazocoto sanitario		Dimensiones de vapos		Ciebraso	
	C	FECHA	C	FECHA	C	FECHA	C	FECHA	C	FECHA	C	FECHA	C	FECHA	C	FECHA	C	FECHA
Muro (Interior)	/		/		/		/											
Muro (Exterior)	/		/		/		/											
Columna	/		/		/		/											
Viguetas	/		/		/		/											
derrame	/		/		/		/											

OBSERVACIONES:

CONTROL DE CALIDAD Firma y sello: BRAYAN GALINDO VEGA CONTROL DE CALIDAD CONSORCIO MARITIMO DEL NORTE	RESPONSABLE DE CAMPO Firma y sello: Ing. Luis M. Vera Castañeda INGENIERO CIVIL REG. CIP 14029	RESIDENTE DE OBRA Firma y sello: DANIEL CARRASCO BUSTAMANTE RESIDENTE DE OBRA REG. CIP N° 98098	SUPERVISIÓN Firma y sello: LUDWIG CARRASCO BUSTAMANTE Ing. Supervisor - CIP 79040 CESEL S.A.
--	---	--	---

000213



PROYECTO:
**MEJORAMIENTO Y RECUPERACIÓN DE LOS SERVICIOS DEL
 DESEMBARCADERO PESQUERO ARTESANAL DE SUPE**

CC275-IVC/ -CMN

Elemento:

VACIADO DE CONCRETO EN VIGA

000212

CONTRATISTA: CONSORCIO MARITIMO DEL NORTE		CLIENTE: FONDO NACIONAL DE DESARROLLO PESQUERO - FONDEPES	
FECHA DE VACIADO:		VOLUMEN A VACIAR:	
TIPO DE ESTRUCTURA:		m3	
DOCUMENTOS DE REFERENCIA:		REGISTRA PROBETAS: SI NO GRUPO:	
REV. N°		OBSERVACIONES:	
METODO DE VACIADO: SIN BOMBA			
f'c DISEÑO / CEMENTO tipo:		SLUMP: 4" - 6" pulgadas	
TAM. MAX. AGREGADO: pulgadas		TEMPERATURA: °C	
TIPO DE ACABADO:		METODO DE CURADO: AGUA	
CHECKLIST PREVIO AL VACIADO		CONTRATISTA	
		CHECK	FECHA
		INICIALES / CHECK	FECHA
Materiales Aprobados (diseños, embebidos, demoldantes, curadores, etc.)	/		
Cambios Aprobados (cambios o modificaciones en elementos a vaciar)	/		
Inspección Topográfica (alineamiento, nivelación, dimensiones, etc.)	/		
Encofrado	/		
Armadura de refuerzo	/		
Limpeza dentro de encofrado	/		
Elementos Embebidos Civiles (anclajes, marcos, etc.)	/		
Elementos Embeb. Mecánicos (pernos de anclajes, tuberías, etc.)	/		
Elementos Embebidos Eléctricos (conduit, red de tierra, etc.)	/		
Elementos Embeb. Sistem. Esp. (conduit, red de tierra, etc.)	/		
Inspección Topográfica de elementos embebidos (alineamiento, nivelación, dimensiones, etc.)	/		
Equipos menores en buen estado (reglas vibratorias, vibradoras de aguja, etc.)	/		
Stock de Materiales (curador, lamina polietileno, vigas tipo puente, mantas de yute, reglas, etc.)	/		
Otro (especificar):			
PRE-VACIADO VERIFICADO POR	NOMBRE:	SUPERVISION	
	FIRMA:		
Ing. Residente - Contratista			
Vº Bº / Aprobación _____			
CHECKLIST POSTERIOR AL VACIADO		CHECK	FECHA
Inspección Topográfica de elementos vaciados (alineamiento, nivelación, dimensiones, etc.)			
Inspección Topográfica de elementos embebidos (alineamiento, nivelación, dimensiones, etc.)			
Buen acabado en el concreto fresco después de colocado.			
Curado adecuado.			
CONFORME CON REPARACIÓN: SI <input type="checkbox"/> NO <input type="checkbox"/> NO APLICA <input type="checkbox"/>		Especificar proceso de reparación:	
COMENTARIOS:			
Responsable de Campo	Sello y Firma: Ing. Luis M. Vera Cavareda INGENIERO CIVIL REG. CIP 140228	Control de Calidad	Sello y Firma: BRAYAN CALINDO VEGA CONTROL DE CALIDAD CONSORCIO MARITIMO DEL NORTE
Residente De Obra	Sello y Firma: LUDWING CARRASCO BUSTAMANTE Ing. Supervisor - CIP 79040 CESEL S.A.	Supervisor de Obra	



PROYECTO: MEJORAMIENTO Y RECUPERACIÓN DE LOS SERVICIOS DEL DESEMBARCADERO PESQUERO ARTESANAL DE SUPE

CC275-IECTC/ -CMN
REGISTRO:

INSPECCION DE ENCOFRADO

Contratista:	CONSORCIO MARITIMO DEL NORTE	
Ciente:	FONDO NACIONAL DE DESARROLLO PESQUERO - FONDEPES	Fecha:
Ubicación:		Documentos de referencia:
Tipo de estructura:		

003711

ESQUEMA DEL ENCOFRADO:

Graficar el elemento, identificar ubicación por ejes, puntualizar detalles del encofrado

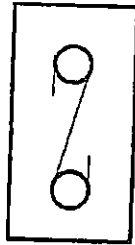

Estructura: 12.5cm x 13 cm
Arquitectura: 15cm x 15 cm

DATOS DIMENSIONALES (mm):

PUNTOS PLOMADA																				
ARRIBA																				
ABAJO																				
DESVIACION																				

CHECKLIST DEL ENCOFRADO:

	CONFORME	NO CONFORME	NO APLICA	REPARADO/CO RREGIDO	COMENTARIOS
Material del encofrado	/				
Condición del encofrado	/				
Formas del encofrado	/				
Dimensiones del encofrado	/				
Aplicación de desmoldante	/				
Aseguramiento de soleras	/				
Apuntalamiento y fijación	/				
Hermeticidad del encofrado	/				
Fecha de desencofrado	/				

COMENTARIOS / OBSERVACIONES GENERALES:

Responsable de Campo:	Sello y Firma: Ing. Luis M. Carrasco INGENIERO CIVIL REG. CIP 140228	Control de Calidad:	Sello y Firma: BRYAN GALINDO VEGA CONTROL DE CALIDAD CONSORCIO MARITIMO DEL NORTE
Residente de Obra:	Sello y Firma: LUDWING CARRASCO BUSTAMANTE Ing. Supervisor - CIP 79040 CESEL S.A.	Supervisor de Obra:	Sello y Firma: LUDWING CARRASCO BUSTAMANTE Ing. Supervisor - CIP 79040 CESEL S.A.

Decenio de la Igualdad de Oportunidad para Mujeres y Hombres
 "Año del Diálogo y Reconciliación Nacional"

000210

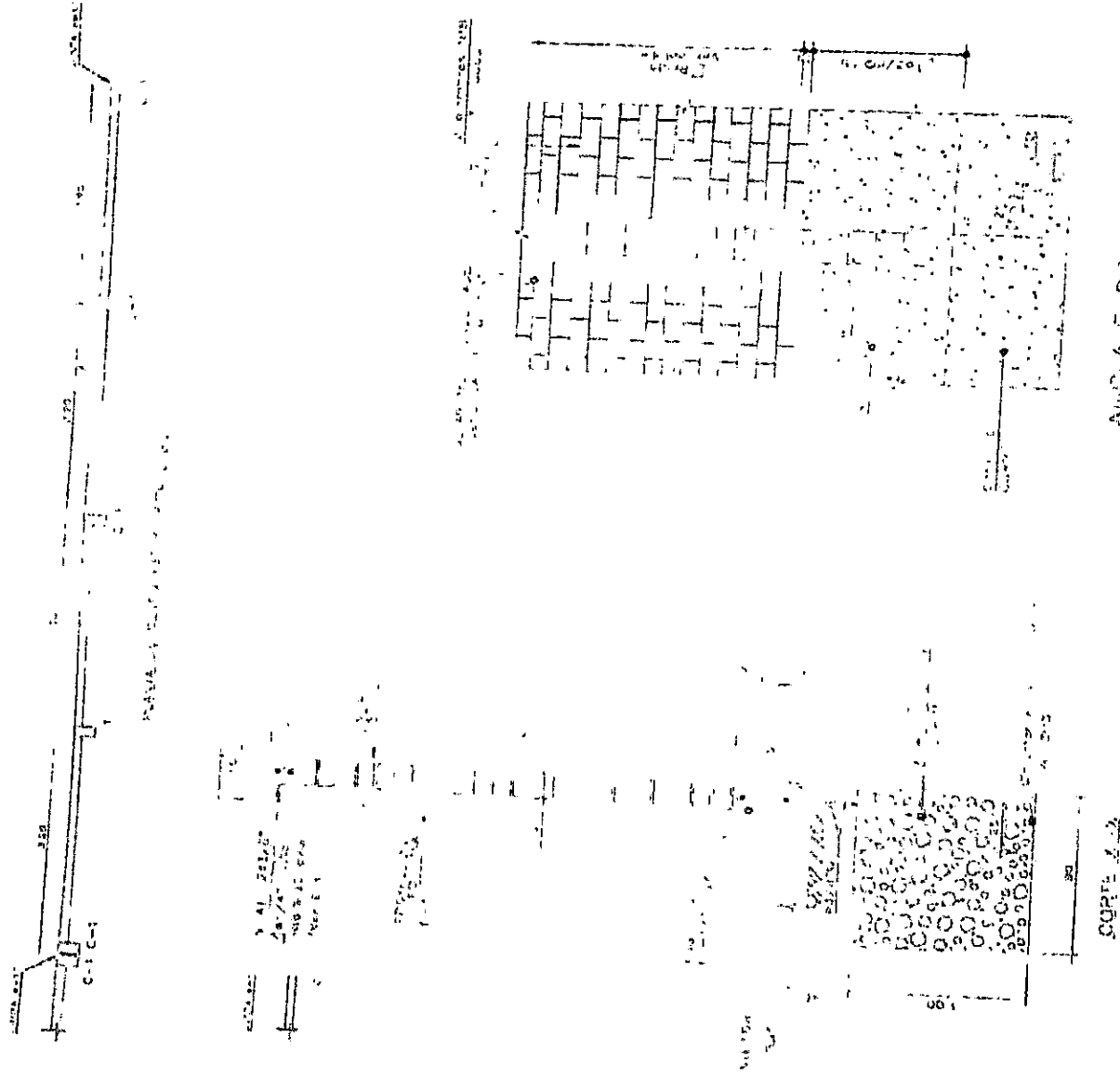

ANEXO DE COLONIAS
 EN MUROS DE ALRULLERA
 EST. 1975

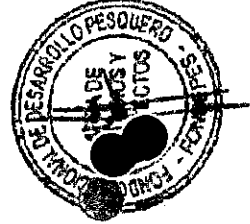

48 12'
 20 15' 16.05' 06.10
 20 15' 16.05' 06.10
 S-1
 1/20

[Handwritten signature]

[Handwritten signature]

Figura 3: Cerco Perimétrico propuesto

[Handwritten signature]

INGENIERO EN PESQUERÍA
 M. GARCÍA CALINCO VEGA
 OFICINA DE CALIDAD
 DESEMPLEO MARITIMO DEL NORTE



INSPECCION DE ACERO DE REFUERZO

CC275-IAR/ -CMN

CLIENTE:	FONDO NACIONAL DE DESARROLLO PESQUERO - FONDEPES	REGISTRO:
CONTRATISTA:	CONSORCIO MARÍTIMO DEL NORTE	
OBRA:	MEJORAMIENTO Y RECUPERACIÓN DE LOS SERVICIOS DEL DESEMBARCADERO PESQUERO ARTESANAL DE SUPE	FECHA:

UBICACION:	DOCUMENTOS DE REFERENCIA:
SECTOR:	0000
T. ESTRUCTURA:	

ESQUEMA DE LA ARMADURA: Graficar el elemento, identificar ubicación por ejes, puntualizar detalles del acero.

CHECKLIST DEL ACERO DE REFUERZO

	CONFORME	NO CONFORME	NO APLICA	REPARADO/CORREGIDO	COMENTARIOS
Limpieza (corrosión, concreto, grasa)	/				
Calidad del acero (Norma ASTM, grado, marca)	//				
Diámetro de varilla	//				
Longitud de traslape	//				
Longitud de gancho	//				
Espaciamiento entre barras	//				
Espaciamiento de estribos	//				
Alcance de amarre	//				
Soportes para recubrimiento contra base	//				
Soportes para recubrimiento lateral	//				
Verticalidad (plomada)	//				
Horizontalidad (nivel)	//				

COMENTARIOS / OBSERVACIONES GENERALES:

Responsable de Campo:	Sello y Firma: Ing. L. Carrasco Bustamante INGENIERO CIVIL REG. CIP 140228	Control de Calidad:	Sello y Firma: GABRIEL GALINDO VEGA CONTROL DE CALIDAD CONSORCIO MARÍTIMO DEL NORTE
Residente de Obra:	Sello y Firma: LUDWING CARRASCO BUSTAMANTE Ing. Supervisor - CIP 79040 CESEL S.A.	Supervisor de Obra:	Sello y Firma: LUDWING CARRASCO BUSTAMANTE Ing. Supervisor - CIP 79040 CESEL S.A.



PROYECTO: MEJORAMIENTO Y RECUPERACIÓN DE LOS SERVICIOS DEL DESEMBARCADERO PESQUERO ARTESANAL DE SUPE

CC275-JECTC/ -CMN
REGISTRO: 000208

INSPECCION DE ENCOFRADO

Contratista:	CONSORCIO MARITIMO DEL NORTE	Fecha:	
Cliente:	FONDO NACIONAL DE DESARROLLO PESQUERO - FONDEPES	Documentos de referencia:	
Ubicación:			
Tipo de estructura:			

ESQUEMA DEL ENCOFRADO:

Grificar el elemento, identificar ubicación por ejes, puntualizar detalles del encofrado

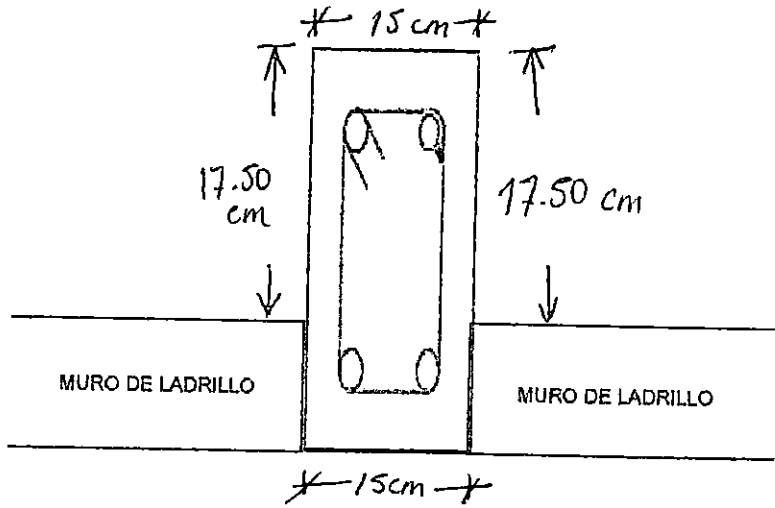

DATOS DIMENSIONALES (mm):

PUNTOS PLOMADA																				
ARRIBA																				
ABAJO																				
DESVIACION																				

CHECLIST DEL ENCOFRADO:

	CONFORME	NO CONFORME	NO APLICA	REPARADO/CO TREGIDO	COMENTARIOS
Material del encofrado	/				
Condición del encofrado	/				
de formas del encofrado	/				
Dimensiones del encofrado	/				
Aplicación de desmoldante	/				
Aseguramiento de soleras	/				
Apuntalamiento y fijación	/				
Hermeticidad del encofrado	/				
Fecha de desencofrado	/				

COMENTARIOS / OBSERVACIONES GENERALES:

Responsable de Campo:	Seño y Firma: Ing. Luis M. Vera Castañeda INGENIERO CIVIL REG. CIP 140228	Control de Calidad:	Seño y Firma: GRAYAN GALINDO VEGA CONTROL DE CALIDAD CONSORCIO MARITIMO DEL NORTE
Residente de Obra:	Seño y Firma: LUDWIG GARRASCO BUSTAMANTE RESIDENTE DE LA OBRA REG. CIP 9038	Supervisor de Obra:	Seño y Firma: LUDWIG GARRASCO BUSTAMANTE Ing. Supervisor - CIP 79040 CESEL S.A.

150+



PROYECTO:
**MEJORAMIENTO Y RECUPERACIÓN DE LOS SERVICIOS DEL
 DESEMBARCADERO PESQUERO ARTESANAL DE SUPE**

CC275-IVCI -CMN

Elemento:

000207

VACIADO DE CONCRETO EN COLUMNETAS

CONTRATISTA: CONSORCIO MARITIMO DEL NORTE		CLIENTE: FONDO NACIONAL DE DESARROLLO PESQUERO - FONDEPES	
FECHA DE VACIADO:		VOLUMEN A VACIAR: m3	
TIPO DE ESTRUCTURA:		REGISTRA PROBETAS: SI <input type="checkbox"/> NO <input type="checkbox"/> GRUPO:	
DOCUMENTOS DE REFERENCIA:		OBSERVACIONES:	
METODO DE VACIADO: SIN BOMBA		SLUMP: 4" - 6"	
f'c DISEÑO / CEMENTO tipo: kg/cm2		TEMPERATURA: °C	
TAFI. MAX. AGRGADO: pulgadas		METODO DE CURADO: AGUA	
TIPO DE ACABADO:			
CHECKLIST PREVIO AL VACIADO		CONTRATISTA	
		CHECK	FECHA
		INICIALES / CHECK	FECHA
Materiales Aprobados (diseños, embebidos, demoldantes, curadores, etc)	/		
Cambios Aprobados (cambios o modificaciones en elementos a vaciar)	/		
Inspección Topográfica (alineamiento, nivelación, dimensiones, etc.)	/		
Encofrado	/		
Armadura de refuerzo	/		
Limpieza dentro de encofrado	/		
Elementos Embebidos Civiles (anclajes, marcos, etc.)	/		
Elementos Embeb. Mecánicos (pernos de anclajes, tuberías, etc.)	/		
Elementos Embebidos Eléctricos (conduit, red de tierra, etc.)	/		
Elementos Embeb. Sistem. Esp. (conduit, red de tierra, etc.)	/		
Inspección Topográfica de elementos embebidos (alineamiento, nivelación, dimensiones, etc.)	/		
Equipos menores en buen estado (reglas vibratorias, vibradores de aguja, etc)	/		
Stock de Materiales (curador, lamina polietileno, vigas tipo puente, mantas de yute, reglas, etc)	/		
Otro (especificar):	/		
PRE-VACIADO VERIFICADO POR	NOMBRE:	SUPERVISION	
	FIRMA:		
Ing. Residente - Contratista			
Vº Bº / Aprobación _____			
CHECKLIST POSTERIOR AL VACIADO		CHECK	FECHA
Inspección Topográfica de elementos vaciados (alineamiento, nivelación, dimensiones, etc.)			
Inspección Topográfica de elementos embebidos (alineamiento, nivelación, dimensiones, etc.)			
Buen acalado en el concreto fresco después de colocado.			
Curado adecuado.			
CONFORME CON REPARACIÓN: SI <input type="checkbox"/> NO <input type="checkbox"/> NO APLICA <input type="checkbox"/>		Especificar proceso de reparación:	
COMENTARIOS:			
Responsable de Campo	Sello y Firma: Ing. Ludw. Carrasco Bustamante INGENIERO CIVIL R.C. CIP 140228	Control de Calidad	Sello y Firma: BRAYAN GALINDO VEGA CONTROL DE CALIDAD CONSORCIO MARITIMO DEL NORTE
Residente De Obra	Sello y Firma: R.C. CIP	Supervisor de Obra	Sello y Firma: LUDWING CARRASCO BUSTAMANTE Ing. Supervisor - CIP 79040 CESEL S.A.

CONSEJO MARITIMO DEL NORTE
BRAYN GALINDO VEGA
CONTROL DE CALIDAD
Galindo

ING. EN CIVIL
INGENIERO CIVIL
REG. CIP 140228

Don
F. N. A.
REG. CIP 140228

BLOQUE 07

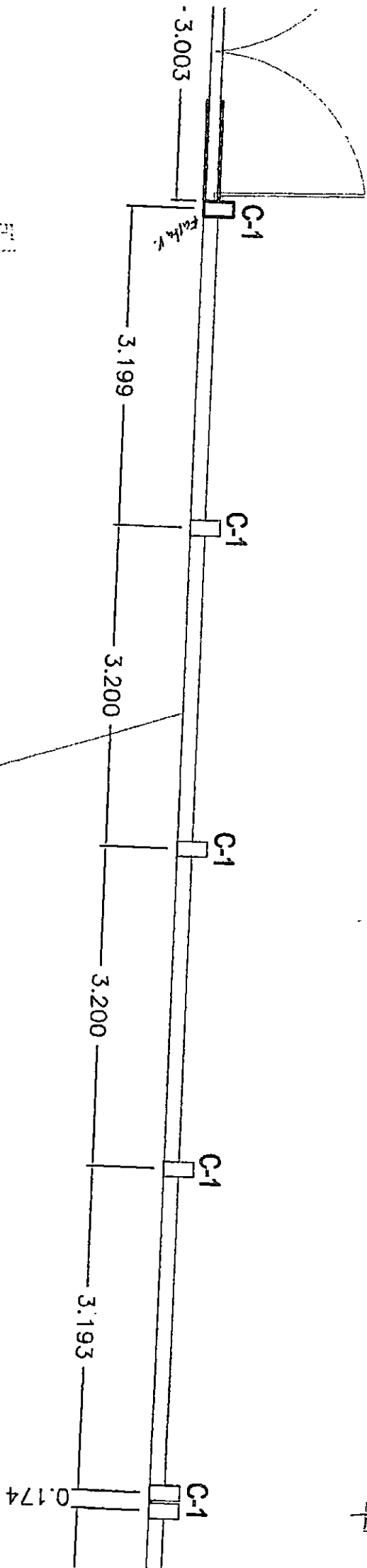

000206

BLOQUE 02.

B02-01

*B-02

000205

NOTA: Acotar las verdaderas dimensiones entre calumetas y de cada calumeta.

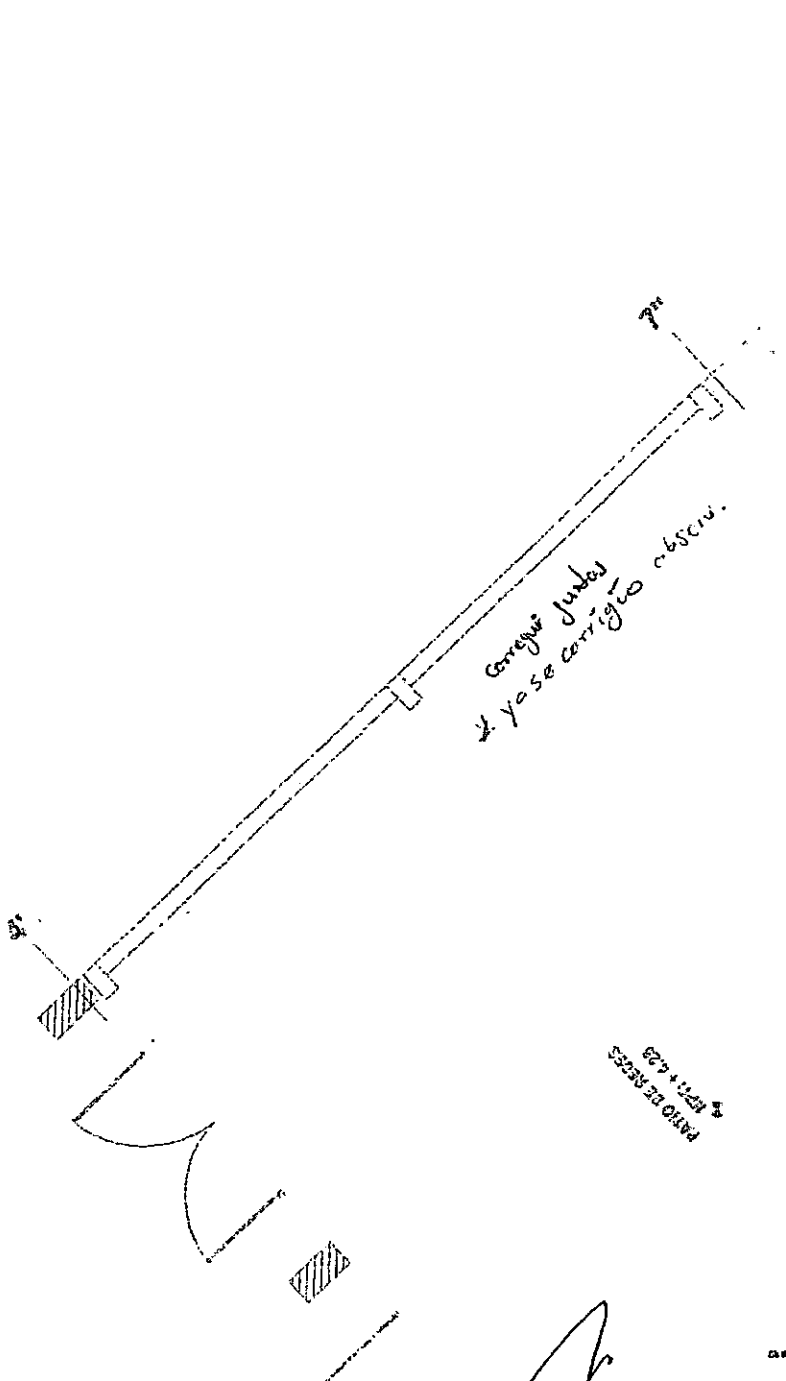

CPD + 1204 *
SANCIONADO
CALUMETA

CPD + 1204 *
SANCIONADO



CONSORCIO MARITIMO DEL NORTE
DESEMBARCADERO ARTESANAL DE SUPE
[Signature]
DANIEL JOAQUIN MORALES VIVAICO
RESIDENTE DE OBRA
REG. CIP N° 98098

[Signature]
BRAYAN GALINDO VEGA
CONTROL DE CALIDAD
CONSORCIO MARITIMO DEL NORTE.

[Signature]
Ing. Luis M. Vera Castañeda
INGENIERO CIVIL
REG. CIP 140228

[Signature]
LUDWIG CARRASCO BUSTAMANTE
Ing. Supervisor - CIP 79040
CESEL S.A.

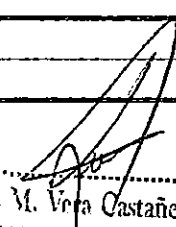
000204

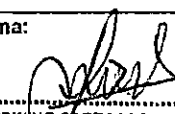
		REGISTRO DE CONTROL ASENTADO DE LADRILLO TIPO IV		CC275-RCAI - CMN	
CLIENTE:	FONDO NACIONAL DE DESARROLLO PESQUERO - FONDEPES			REGISTRO:	
CONTRATISTA:	CONSORCIO MARITIMO DEL NORTE				
OBRA:	MEJORAMIENTO Y RECUPERACIÓN DE LOS SERVICIOS DEL DESEMBARCADERO PESQUERO ARTESANAL DE SUPE			FECHA: 31-02-19	
Elemento: Muro de Cero (Patio de Redes).		Codigo de Tabique:			
Area Asentada (m2): 18.89 m ²		Fecha del Asentado: 31-02-19			
Etapa:					
Documentos de Referencia		Revisión		Observaciones	
EJE: 4" - 7"					
Lista de Verificación Previa al Asentado (Ver Plano de Detalle)		FECHA	CONTRATISTA	SUPERVISION	CONFORMIDAD
Sobrecimiento de Muro Terminado		31-02-19	/		
Trazo definido		31-02-19	/		
Espesor de juntas definidas		31-01-19	/		
Alineamiento		31-01-19	/		
Refuerzos		31-01-19	/		
Autorizado para el Asentado		31-01-19	/		
Ladrillo humedecido		30-01-19	/		
Inicio de Asentado		31-01-19	/		
SUPERVISOR CALIDAD:				Fecha:	
Lista de Verificación Posterior al Asentado		FECHA	CONTRATISTA	SUPERVISION	CONFORMIDAD
Variación: <input type="checkbox"/> Vertical <input type="checkbox"/> Nivel <input type="checkbox"/> Juntas asentado					
Verificación de Verticalidad					
Verificación de Refuerzo					
Elementos Embebidos: Anclajes					
<input type="checkbox"/> Acero <input type="checkbox"/> Mecanico <input type="checkbox"/> Sanitario <input type="checkbox"/> Electricos					
Huecos de limpieza clausurados					
Corte de Mortero de Juntas al ras					
Comentarios:					
Responsable Campo	Sello y Firma:  Luis M. Vera Castañeda INGENIERO CIVIL CIP 140228		Control de Calidad	Sello y Firma:  BRAYAN GALINDO VEGA CONTROL DE CALIDAD CONSORCIO MARITIMO DEL NORTE	
Residente de Obra	Sello y Firma:  DANIEL JOAQUÍN MORALES VIVAS RESIDENTE DE OBRA REG. CIP N° 96098		Supervisor de Obra	Sello y Firma:  LUDWIG BARRASCO BUSTAMANTE Ing. Supervisor - CIP 79040 CESEL S.A.	



PROYECTO:
**MEJORAMIENTO Y RECUPERACIÓN DE LOS SERVICIOS DEL
DESEMBARCADERO PESQUERO ARTESANAL DE SUPE**

CC275-IVC/ -CMN
Elemento:

VACIADO DE CONCRETO EN COLUMNETAS

CONTRATISTA: CONSORCIO MARITIMO DEL NORTE		CLIENTE: FONDO NACIONAL DE DESARROLLO PESQUERO - FONDEPES	
FECHA DE VACIADO:		VOLUMEN A VACIAR: 0.45 m3	
TIPO DE ESTRUCTURA:		REGISTRA PROBETAS: SI <input checked="" type="checkbox"/> NO <input type="checkbox"/>	
DOCUMENTOS DE REFERENCIA:		OBSERVACIONES:	
METODO DE VACIADO: SIN BOMBA		GRUPO:	
f'c DISEÑO / CEMENTO tipo:		SLUMP: 4" - 6" pulgadas	
TAM. MAX. AGREGADO:		TEMPERATURA: °C	
TIPO DE ACABADO:		METODO DE CURADO: AGUA	
CHECKLIST PREVIO AL VACIADO		CONTRATISTA	
		SUPERVISION	
		CHECK	FECHA
		INICIALES / CHECK	FECHA
Materiales Aprobados (diseños, embebidos, demoldantes, curadores, etc)		/	
Cambios Aprobados (camitos o modificaciones en elementos a vaciar)		/	
Inspección Topográfica (alineamiento, nivelación, dimensiones, etc.)		/	
Encofrado		/	
Armadura de refuerzo		/	
Limpieza dentro de encofrado		/	
Elementos Embebidos Civiles (anclajes, marcos, etc.)		/	
Elementos Embeb. Mecánicos (pernos de anclajes, tuberías, etc.)		/	
Elementos Embebidos Eléctricos (conduit, red de tierra, etc.)		/	
Elementos Embeb. Sistem. Esp. (conduit, red de tierra, etc.)		/	
Inspección Topográfica de elementos embebidos (alineamiento, nivelación, dimensiones, etc.)		/	
Equipos menores en buen estado (reglas vibratorias, vibradoras de aguja, etc)		/	
Stock de Materiales (curador, lmina polietileno, vigas tipo puente, mantas de yute, reglas, etc)		/	
Otro (especificar):			
PRE-VACIADO VERIFICADO POR		SUPERVISION	
NOMBRE:			
FIRMA:			
Ing. Residente - Contratista			
Vº Bº / Aprobación			
CHECKLIST POSTERIOR AL VACIADO		CHECK	FECHA
Inspección Topográfica de elementos vaciados (alineamiento, nivelación, dimensiones, etc.)			
Inspección Topográfica de elementos embebidos (alineamiento, nivelación, dimensiones, etc.)			
Buen acabado en el concreto fresco después de colocado.			
Curado adecuado.			
CONFORME CON REPARACIÓN:		Especificar proceso de reparación:	
SI <input type="checkbox"/> NO <input type="checkbox"/> NO APLICA <input type="checkbox"/>			
COMENTARIOS:			
Responsable de Campo	Sello y Firma: Ing. Luis M. Vique / Carrasco INGENIEIRO CIVIL REG. CIP 140228	Control de Calidad	Sello y Firma: BRAYAN GALINDO VEGA CONTROL DE CALIDAD CONSORCIO MARITIMO DEL NORTE
Residente De Obra	Sello y Firma: CONSORCIO MARITIMO DEL NORTE DESEMBARCADERO PESQUERO ARTESANAL DE SUPE DANIEL R. G. C. P. 140228	Supervisor de Obra	Sello y Firma: LUDWING CARRASCO BUSTAMANTE Ing. Supervisor - CIP 7962 GESEL S. S.



PROYECTO: MEJORAMIENTO Y RECUPERACIÓN DE LOS SERVICIOS DEL DESEMBARCADERO PESQUERO ARTESANAL DE SUPE

CC275-IECTCI -CMN
REGISTRO:

INSPECCION DE ENCOFRADO

Contratista:	CONSORCIO MARITIMO DEL NORTE	Fecha:	003202
Cliente:	FONDO NACIONAL DE DESARROLLO PESQUERO - FONDEPES	Documentos de referencia:	
Ubicación:			
Tipo de estructura:			

ESQUEMA DEL ENCOFRADO:

Graficar el elemento, identificar ubicación por ejes, puntualizar detalles del encofrado

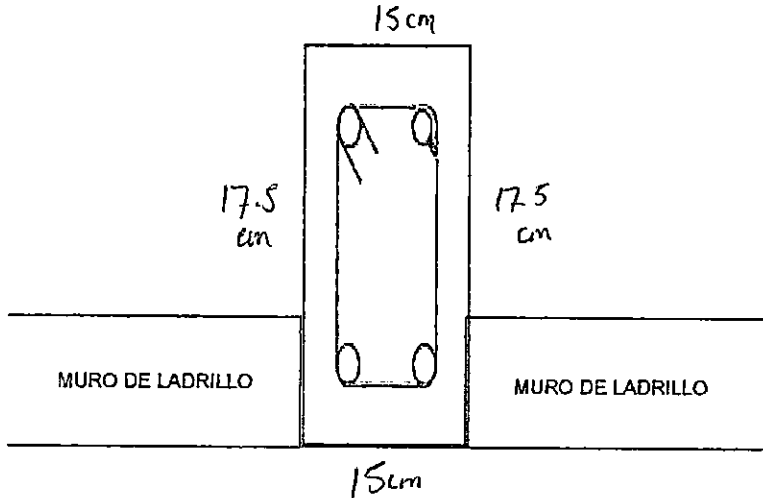

DATOS DIMENSIONALES (mm):

PUNTOS PLOMADA										
ARRIBA										
ABAJO										
DESVIACION										

CHECKLIST DEL ENCOFRADO:

	CONFORME	NO CONFORME	NO APLICA	REPARADO/CO RREGIDO	COMENTARIOS
Material del encofrado	/				
Condición del encofrado	/				
Empieza de formas del encofrado	/				
Forma y dimensiones del encofrado	/				
Aplicación de desmoldante	/				
Aseguramiento de soleras	/				
Apuntalamiento y fijación	/				
Hermeticidad del encofrado	/				
Fecha de desencofrado	/				

COMENTARIOS / OBSERVACIONES GENERALES:

Responsable de Campo:	Sello y Firma: Ing. Luis A. Vera Castañeda INGENIERO CIVIL REG. CIP 140228	Control de Calidad:	Sello y Firma: BRAYAN GALINDO VEGA CONTROL DE CALIDAD CONSORCIO MARITIMO DEL NORTE
Residente de Obra:	Sello y Firma: CONSORCIO MARITIMO DEL NORTE DESEMBARCADERO PESQUERO ARTESANAL DE SUPE DANIEL A. ... REG. CIP ...	Supervisor de Obra:	Sello y Firma: LUDWING CARRASCO MUSTAMAN Ing. Supervisor - CIP 78060 CESEL S.A.

		INSPECCION DE ACERO DE REFUERZO	CC275-IAR/ -CMN
CLIENTE:	FONDO NACIONAL DE DESARROLLO PESQUERO - FONDEPES	REGISTRO:	
CONTRATISTA:	CONSORCIO MARITIMO DEL NORTE	000201	
OBRA:	MEJORAMIENTO Y RECUPERACION DE LOS SERVICIOS DEL DESEMBARCADERO PESQUERO ARTESANAL DE SUPE	FECHA:	



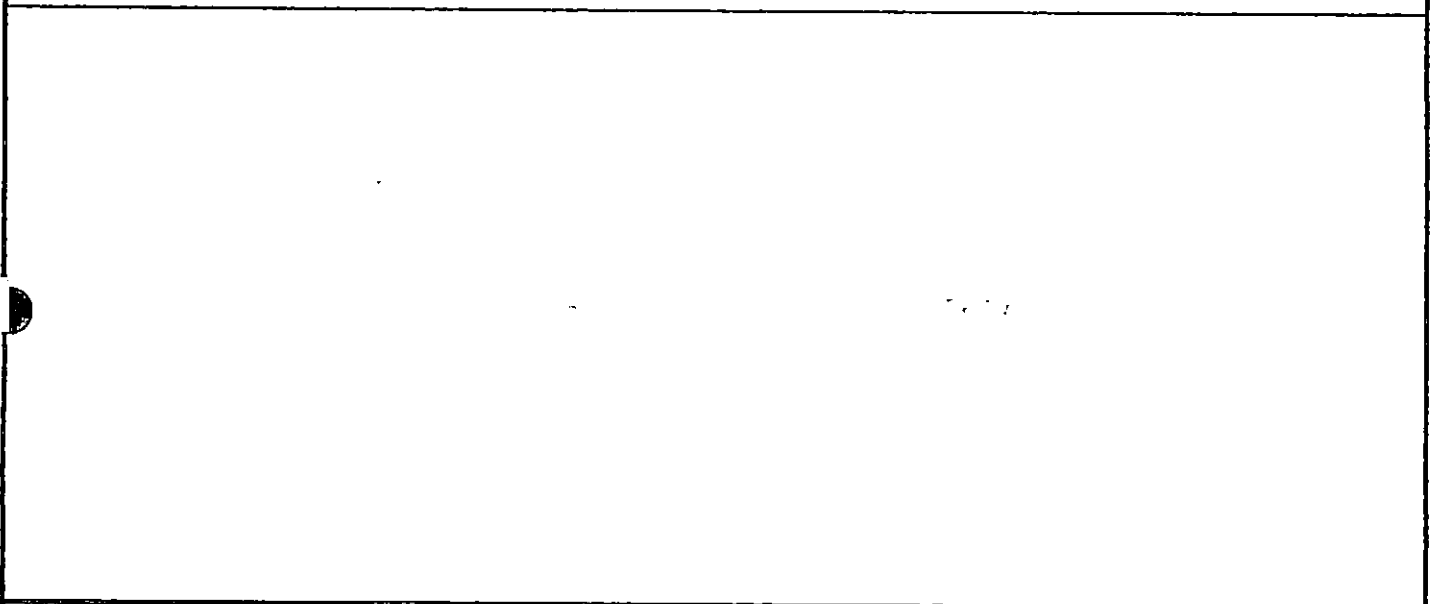

UBICACION:	DOCUMENTOS DE REFERENCIA:
SECTOR:	
T. ESTRUCTURA :	

ESQUEMA DE LA ARMADURA: Graficar el elemento, identificar ubicacion por ejes, puntualizar detalles del acero.

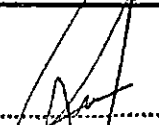

CHECKLIST DEL ACERO DE REFUERZO					
	CONFORME	NO CONFORME	NO APLICA	REPARADO/CORREGIDO	COMENTARIOS
Limpieza (corrosión, concreto, grasa)	/				
Calidad del acero (Norma ASTM, grado, marca)	/				
Diámetro de varilla	/				
Longitud de traslape	/				
Longitud de gancho	/				
Espaciamiento entre barras	/				
Espaciamiento de estribos	/				
Alambre de amarre	/				
Soportes para recubrimiento contra base	/				
Soportes para recubrimiento lateral	/				
Verticalidad (plomada)	/				
Horizontalidad (nivel)	/				

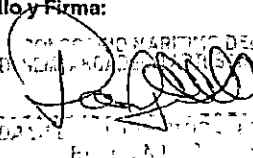
COMENTARIOS / OBSERVACIONES GENERALES:

Responsable de Campo:	Sello y Firma:  Ing. Luis M. Ver. Castañeda INGENIERO CIVIL REG. CIP 140228	Control de Calidad:	Sello y Firma:  BRAYAN GALINDO VEGA CONTROL DE CALIDAD CONSORCIO MARITIMO DEL NORTE
Residente de Obra:	Sello y Firma:  CONSORCIO MARITIMO DEL NORTE INGENIERO CIVIL REG. CIP 79040 CESEL S.A.	Supervisor de Obra:	Sello y Firma:  LUDWING CARRASCO BUSTAMANTE Ing. Supervisor - CIP 79040 CESEL S.A.

"Decenio de la Igualdad de Oportunidad para Mujeres y Hombres"
"Año del Diálogo y Reconciliación Nacional"

000200

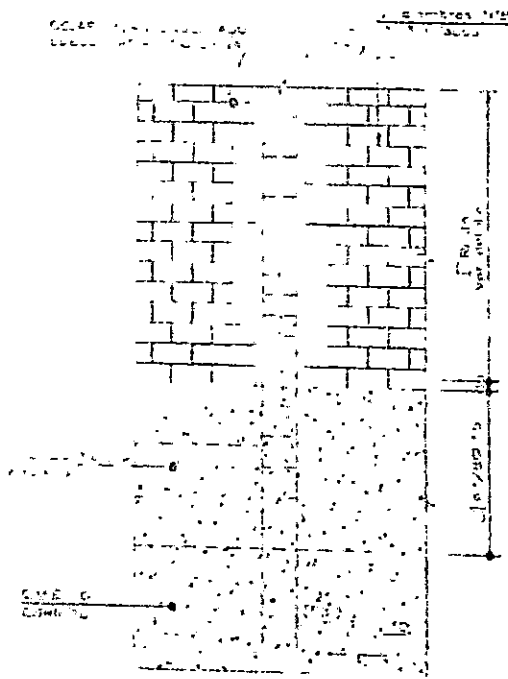
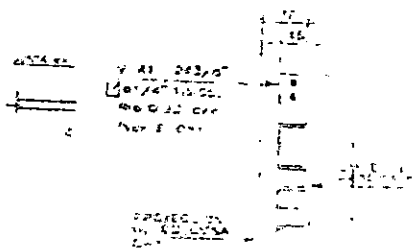
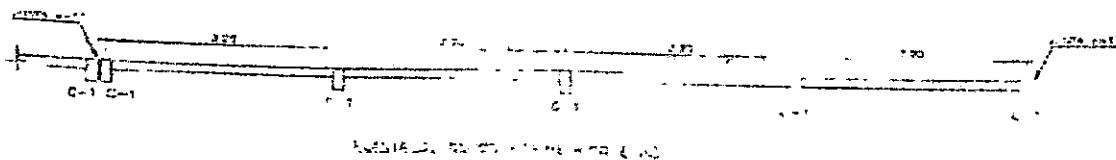

ANCLAJE DE COLUMNAS
EN MUROS DE ALBAÑILERIA
ESCALA 1/20

Galindo
BRAYN GALINDO VEGA
CONTROL DE CALIDAD
CIENFUEGOS, MATAGUAY, CUBA

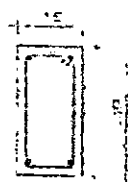

30,00 10,00 20,00
20 15. No. 0,25 0,25

C-1
E.C. 1/20



[Signature]
DISEÑADOR
REVISOR

Figura 3: Cerco Perimétrico propuesto



PROYECTO: MEJORAMIENTO Y RECUPERACIÓN DE LOS SERVICIOS DEL DESEMBARCADERO PESQUERO ARTESANAL DE SUPE 000199

CC275-IECTCI -CMN
REGISTRO:

INSPECCION DE ENCOFRADO

Contratista:	CONSORCIO MARITIMO DEL NORTE	Fecha:	
Cliente:	FONDO NACIONAL DE DESARROLLO PESQUERO - FONDEPES	Documentos de referencia:	
Ubicación:			
Tipo de estructura:			

ESQUEMA DEL ENCOFRADO:
Graficar el elemento, identificar ubicación por ejes, puntualizar detalles del encofrado

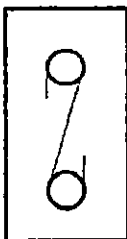

Estructura: 12.5cm x 13 cm
Arquitectura: 15cm x 15 cm

DATOS DIMENSIONALES (mm):

PUNTOS PLOMADA																				
ARRIBA																				
ABAJO																				
DESVIACION																				

CHECKLIST DEL ENCOFRADO:					COMENTARIOS
	CONFORME	NO CONFORME	NO APLICA	REPARADO/CO RREGIDO	
Material del encofrado	/				
Condición del encofrado	/				
Pieza de formas del encofrado	/				
Forma y dimensiones del encofrado	/				
Aplicación de desmoldante	/				
Aseguramiento de soleras	/				
Apuntalamiento y fijación	/				
Hermaticidad del encofrado	/				
Fecha de desencofrado	/				

COMENTARIOS / OBSERVACIONES GENERALES:

Responsable de Campo:	Sello y Firma: Ing. Luis M. Vera Catañeda INGENIERO CIVIL REG. CIP 140228	Control de Calidad:	Sello y Firma: BRAYAN GALINDO VELA CONTROL DE CALIDAD CONSORCIO MARITIMO DEL NORTE
Residente de Obra:	Sello y Firma: LUDWING CARRASCO BUSTAMANTE REG. CIP N. 60000	Supervisor de Obra:	Sello y Firma: LUDWING CARRASCO BUSTAMANTE Ing. Supervisor - CIP 79040 CESEL S.A.

000198



PROYECTO:
MEJORAMIENTO Y RECUPERACIÓN DE LOS SERVICIOS DEL DESEMBARCADERO PESQUERO ARTESANAL DE SUPE

CC275-IVC/ -CMN
Elemento:

VACIADO DE CONCRETO EN VIGA

CONTRATISTA: CONSORCIO MARITIMO DEL NORTE		CLIENTE: FONDO NACIONAL DE DESARROLLO PESQUERO - FONDEPES	
FECHA DE VACIADO:		VOLUMEN A VACIAR:	m3
TIPO DE ESTRUCTURA:		REGISTRA PROBETAS:	SI NO GRUPO:
DOCUMENTOS DE REFERENCIA:	REV. N°	OBSERVACIONES:	
METODO DE VACIADO: SIN BOMBA			
Fc DISEÑO / CEMENTO tipo:	kn/cm2	SLUMP:	4" - 6" pulgadas
TAM. MAX. AGREGADO:	pulgadas	TEMPERATURA:	°C
TIPO DE ACABADO:		METODO DE CURADO: AGUA	
CHECKLIST PREVIO AL VACIADO		CONTRATISTA SUPERVISION	
		CHECK	FECHA
		INICIALES / CHECK	FECHA
Material Aprobados (diseños, embebidos, demoldantes, curadores, etc.)		/	
Cambios Aprobados (cambios o modificaciones en elementos a vaciar)		/	
Inspección Topográfica (alineamiento, nivelación, dimensiones, etc.)		/	
Encofrado		/	
Armadura de refuerzo		/	
Limpieza dentro de encofrado		/	
Elementos Embebidos Civiles (anclajes, marcos, etc.)		/	
Elementos Embeb. Mecánicos (pernos de anclajes, tuberías, etc.)		/	
Elementos Embebidos Eléctricos (conduit, red de tierra, etc.)		/	
Elementos Embeb. Sistem. Esp. (conduit, red de tierra, etc.)		/	
Inspección Topográfica de elementos embebidos (alineamiento, nivelación, dimensiones, etc.)		/	
Equipos menores en buen estado (reglas vibratorias, vibradoras de aguja, etc.)		/	
Stock de Materiales (curador, lamina polietileno, vigas tipo puente, mantas de yute, reglas, etc.)		/	
Otro (especificar):			
PRE-VACIADO VERIFICADO POR		SUPERVISION	
	NOMBRE:		
	FIRMA:		
Ing. Residente - Contratista			
Vº Bº / Aprobación _____			
CHECKLIST POSTERIOR AL VACIADO		CHECK	FECHA
Inspección Topográfica de elementos vaciados (alineamiento, nivelación, dimensiones, etc.)			
Inspección Topográfica de elementos embebidos (alineamiento, nivelación, dimensiones, etc.)			
Buen acabado en el concreto fresco después de colado.			
Curado adecuado.			
CONFORME CON REPARACIÓN: SI <input type="checkbox"/> NO <input type="checkbox"/> NO APLICA <input type="checkbox"/>		Especificar proceso de reparación:	
COMENTARIOS: Antes de vaciar la viga, prever pasos flexibles para instalaciones eléctricas.			
Responsable de Campo	Sello y Firma: Ing. Luis M. Vero Castañeda INGENIERO CIVIL REG. CIP 140220	Control de Calidad	Sello y Firma: BRAYAN GALINDO VEGA CONTROL DE CALIDAD CONSORCIO MARITIMO DEL NORTE
Residente De Obra	Sello y Firma: DANIEL J. CARRASCO BUSTAMANTE INGENIERO CIVIL REG. CIP 140220	Supervisor de Obra	Sello y Firma: LUDWIG CARRASCO BUSTAMANTE Ing. Supervisor - CIP 79040 CESEL S.A.



CONTROL DE CALIDAD

INSPECCION DE TARRAJEOS Y DERRAMES

NOBRE DEL PROYECTO: MEJORAMIENTO Y RECUPERACIÓN DE LOS SERVICIOS DEL DESEMBARCADERO PESQUERO ARTESANAL DE SUPE **FECHA:** 26/02/17
CLIENTE: FONDO NACIONAL DE DESARROLLO PESQUERO - FONDEPES **SECTORS:** Pano de Rocks
CONTRATISTA: CONSORCIO MARITIMO DEL NORTE **AREA:** Muro de Cerco en punta de redes.

Verificaciones Generales:
 Limpieza Rugosidad Humedad

SECCION DE APORTE 20% A FAVOR DEL CLIENTE - IDENTIFICADA EN EL PLAN DE CONSTRUCCION A. 02.17.110

Ambiente / Eje	Alineamiento de muros		Verticalidad de muros		Uniformidad de muros		Tarrajeo Calibrado de Muro		Eccentrico cielo raso-muro tipo Media Caña		Verticalidad de derrame		Contrazocalo sanitario		Dimensiones de vanos		Cieloraso	
	C	FECHA	C	FECHA	C	FECHA	C	FECHA	C	FECHA	C	FECHA	C	FECHA	C	FECHA	C	FECHA
Muro (Interior)	/		/		/		/											
Muro (Exterior)	/		/		/		/											
Columneta	/		/		/		/											
Viguela	/		/		/		/											
derrame.	/		/		/		/											

OBSERVACIONES:

CONTROL DE CALIDAD Firma y sello: BRAVA GALINDO VEGA CONTROL DE CALIDAD CONSORCIO MARITIMO DEL NORTE	RESPONSABLE DE CAMPO Firma y sello: Ing. Luis M. Vire Castañeda INGENIERO CIVIL CIP 140228	RESIDENTE DE OBRA Firma y sello: ING. LUDWING CARRASCO BUSTAMANTE SUPERVISOR REG. CIP N° 95036	SUPERVISIÓN Firma y sello: LUDWING CARRASCO BUSTAMANTE Ing. Supervisor - CIP 79040 CESEL S.A.
---	---	---	--

000197

BLOQUE 09.

B69-01

000196

UBICACIÓN DE CASETA DE SEGURIDAD "2"

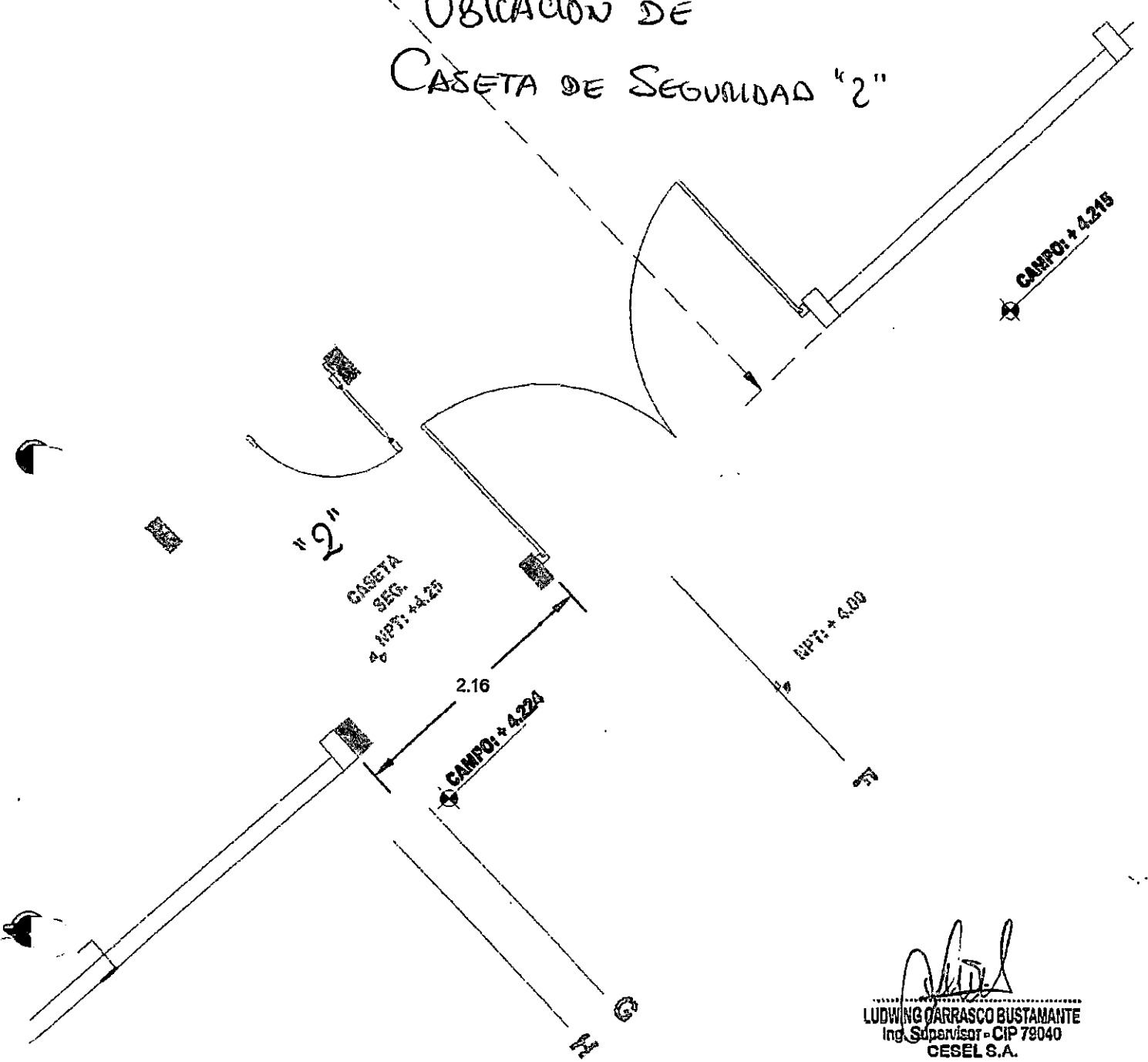

[Signature]
 LUDWIG GARRASCO BUSTAMANTE
 Ing. Supervisor - CIP 78040
 CESEL S.A.

CONSORCIO MARITIMO DEL NORTE
 DESEMBARCO PUERTO ARTESANAL DE SUPE
[Signature]
 DANIEL JOAQUIN MORALES VIVIANO
 RESIDENTE DE OBRA
 REG. CIP N° 98098

[Signature]
 BRAYAN GALINDO VEGA
 CONTROL DE CALIDAD
 CONSORCIO MARITIMO DEL NORTE

[Signature]
 Ing. Luis M. V. C. C. C.
 INGENIERO CIVIL
 REG. CIP 140228

CALLE CALLAO

B.10

B09-02

00016



PROYECTO
**MEJORAMIENTO Y RECUPERACIÓN DE LOS SERVICIOS DEL
 DESEMBARCADERO PESQUERO ARTESANAL DE SUPE**

CC276- CC/ - CMN
 Elemento:

CONTROL DE EXCAVACIONES

CONTRATISTA: **CONSORCIO MARÍTIMO DEL NORTE**

CLIENTE: **FONDO NACIONAL DE DESARROLLO PESQUERO - FONDEPES**

DATOS ESPECÍFICOS

NIVEL/ÁREA/SECTOR: **CASETA DE SEGURIDAD "2"**

EJES: **G-F**

MATERIAL: **AFIRMADO**

FECHA: **31-01-19**

DATOS DE ENSAYOS	PLANO
VERIFICACIÓN	
COTA DE FONDO: +2.00	
COTA SUPERIOR: +4.10	
ALTURA DE CORTE: 2.10 m	
ÁREA DE CORTE: 5.66 m²	
VOLUMEN DE EXCAVACION: 11.89	
C: CONFORME NC: NO CONFORME	

COMENTARIOS:

Responsable Campo	Sello y Firma: Ing. Luis M. Vera Castañeda INGENIERO CIVIL REG. CIP 140228	Control de Calidad	Sello y Firma: DRAYAN GUILLERMO VEGA CONTROL DE CALIDAD CONSORCIO MARITIMO DEL NORTE
Residente de Obra	Sello y Firma: CONSORCIO MARITIMO DEL NORTE DESEMBARCADERO ARTESANAL DE SUPE S.A. DANIEL JOAQUÍN MORALES RESIDENTE DE OBRA REG. CIP N° 95508	Supervisor de Obra:	Sello y Firma: LUDWING CARRASCO BUSTAMANTE Ing. Supervisor - CIP 79040 CESEL S.A.

000194



PROYECTO
**MEJORAMIENTO Y RECUPERACIÓN DE LOS SERVICIOS DEL
 DESEMBARCADERO PESQUERO ARTESANAL DE SUPE**

CC275- CC/ - CMN
 Elemento:

CONTROL DE RELLENO DE PIEDRA OVER

CONTRATISTA: **CONSORCIO MARÍTIMO DEL NORTE**
 CLIENTE: **FONDO NACIONAL DE DESARROLLO PESQUERO - FONDEPES**

DATOS ESPECÍFICOS
 NIVEL/ÁREA/SECTOR: **CASETA DE SEGURIDAD**
 EJES: **G-F**
 MATERIAL: **PIEDRA OVER**
 FECHA: **31-01-19**

DATOS DE ENSAYOS	PLANO
VERIFICACIÓN	
<p>GOTA DE FONDO: +2.00</p> <p>GOTA DE RELLENO: +2.50</p> <p>ALTURA DE RELLENO: 50 cm</p> <p>ÁREA DE RELLENO: 5.15 m^2 (2.60 x 2.55)</p>	
<p>C: CONFORME NC: NO CONFORME</p>	

OBSERVACIONES:

Responsable Campo	Sello y Firma: Ing. Luis M. Vera Castañeda INGENIERO CIVIL REIC CIP 140228	Control de Calidad	Sello y Firma: BRAYAN GALINDO VEGA CONTROL DE CALIDAD CONSORCIO MARÍTIMO DEL NORTE
Residente de Obra	Sello y Firma: CONSORCIO MARÍTIMO DEL NORTE DESEMBARCADERO ARTESANAL DE SUPE DANIEL JOAQUÍN RESIDENTE DE OBRA	Supervisor de Obra:	Sello y Firma: LUDWING CARRASCO BUSTAMANTE Ing. Supervisor - CIP 78040 CESEL S.A.



PROYECTO: MEJORAMIENTO Y RECUPERACIÓN DE LOS SERVICIOS DEL DESEMBARCADERO PESQUERO ARTESANAL DE SUPE

CC275-IECTC/ -CMIN
REGISTRO:

INSPECCION DE ENCOFRADO EN SOBRECIMIENTO

Contratista:	CONSORCIO MARITIMO DEL NORTE		Fecha:	
Ciente:	FONDO NACIONAL DE DESARROLLO PESQUERO - FONDEPES		Documentos de referencia:	
Ubicación:	CASETO DE SEGURIDAD (EIE:G-T)			
Tipo de estructura:	ZAPATA, CIMENTO, SOBRECIMIENTO			000-00

ESQUEMA DEL ENCOFRADO:
Graficar el elemento, identificar ubicación por ejes, puntualizar detalles del encofrado

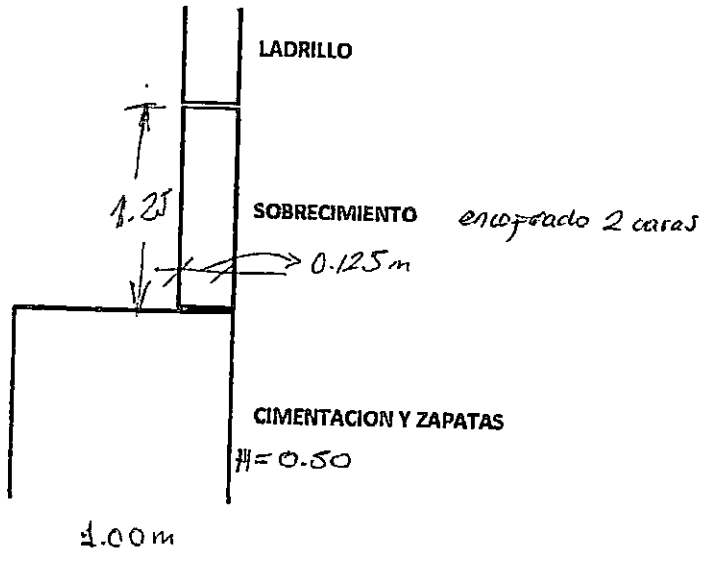

DATOS DIMENSIONALES (mm):

PUNTOS PLOMADA																				
ARRIBA																				
ABAJO																				
DESVIACION																				

CHECKLIST DEL ENCOFRADO:

	CONFORME	NO CONFORME	NO APLICA	REPARADO/CO RREGIDO	COMENTARIOS
Material del encofrado	/				
Condición del encofrado	/				
Plata de formas del encofrado	/				
Formas y dimensiones del encofrado	/				
Aplicación de desmoldante	/				
Aseguramiento de soleras	/				
Apuntalamiento y fijación	/				
Hermeticidad del encofrado	/				
Fecha de desencofrado	/				

COMENTARIOS / OBSERVACIONES GENERALES:

Responsable de Campo:	Sello y Firma: Luis M. Vera Castañeda INGENIERO CIVIL REG. CIP 140228	Control de Calidad:	Sello y Firma: BRAYAN GALINDO VEGA CONTROL DE CALIDAD CONSORCIO MARITIMO DEL NORTE
Recidente de Obra:	Sello y Firma: CONSORCIO MARITIMO DEL NORTE DESEMBARCADERO PESQUERO ARTESANAL DE SUPE DANIEL JOAQUIN MORALES V.M. I.C.U. RESIDENTE DE OBRA REG. CIP Nº 88093	Supervisor de Obra:	Sello y Firma: LUDWIG CARRASCO BUSTAMANTE Ing. Supervisor - CIP 78040 CESEL S.A.



INSPECCION DE ACERO DE REFUERZO

CC275-IA-000-92
000-92
-CMN

CLIENTE:	FONDO NACIONAL DE DESARROLLO PESQUERO - FONDEPES	REGISTRO:
CONTRATISTA:	CONSORCIO MARÍTIMO DEL NORTE	
OBRA:	MEJORAMIENTO Y RECUPERACIÓN DE LOS SERVICIOS DEL DESEMBARCADERO PESQUERO ARTESANAL DE SUPE	FECHA:

UBICACION:	COSMETO DE SEQUEIDAD	DOCUMENTOS DE REFERENCIA:
SECTOR:	ELE 6-#	
T. ESTRUCTURA:	ZAPATO, SOBRECIMIENTO, COLUMNA	

ESQUEMA DE LA ARMADURA: Graficar el elemento, identificar ubicación por ejes, puntualizar detalles del acero.

SE ADJUNTO DETALLE

CHECKLIST DEL ACERO DE REFUERZO

	CONFORME	NO CONFORME	NÓ APLICA	REPARADO/CORREGIDO	COMENTARIOS
Limpieza (corrosión, concreto, grasa)	/				
Calidad del acero (Norma ASTM, grado, marca)	/				
Diámetro de varilla	/				
Longitud de traslape	/				
Longitud de gancho	/				
Espaciamiento entre barras	/				
Espaciamiento de estribos	/				
Tamaño de amarre	/				
Soportes para recubrimiento contra base	/				
Soportes para recubrimiento lateral	/				
Verticalidad (plomada)	/				
Horizontalidad (nivel)	/				

COMENTARIOS / OBSERVACIONES GENERALES:

Responsable de Campo:	Sello y Firma: Ing. Luis M. Verra Castañeda INGENIERO CIVIL REG. CIP 140228	Control de Calidad:	Sello y Firma: BRAYAN GANINDO VEGA CONTROL DE CALIDAD CONSORCIO MARÍTIMO DEL NORTE
Residente de Obra:	Sello y Firma: CONSORCIO MARÍTIMO DEL NORTE DESEMBARCADERO PESQUERO ARTESANAL DE SUPE DANIEL JOAQUÍN MORALES VIQUE RESIDENTE DE OBRA REG. CIP N° 95033	Supervisor de Obra:	Sello y Firma: LUDWING CARRASCO BUSTAMANTE Ing. Supervisor - CIP 79040 CESEL S.A.

DETALLE TOPOGRÁFICO

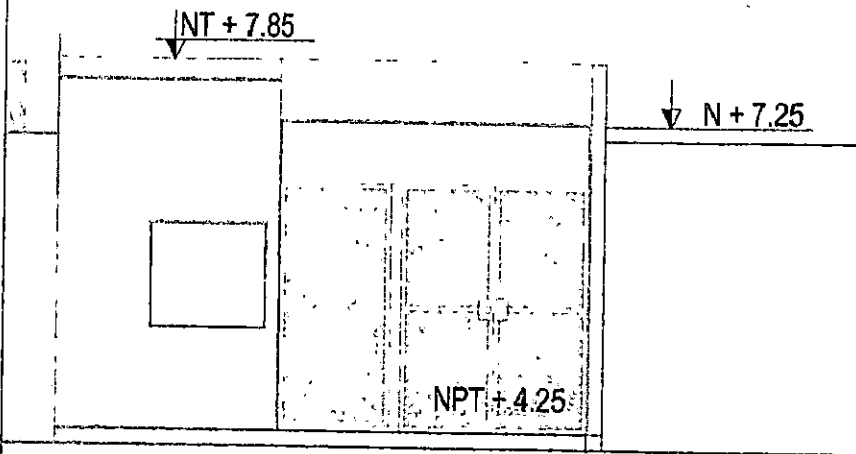

Ing. Luis M. Vera Castañeda
INGENIERO CIVIL
REG. CIP 140228

BRIGADA CALIDAD
CONTROL DE CALIDAD
CONSORCIO ADMINISTRATIVO DPT. 1

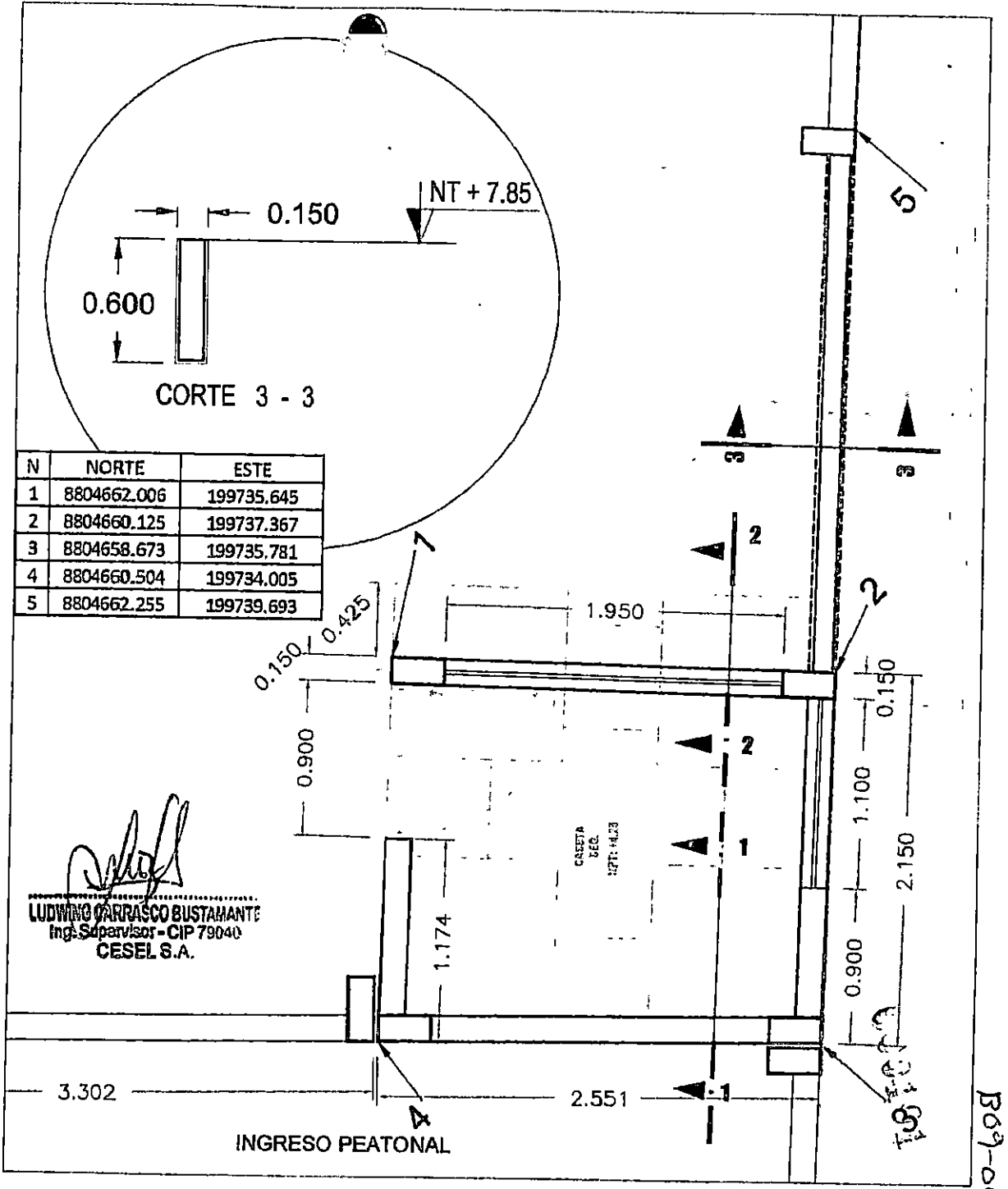
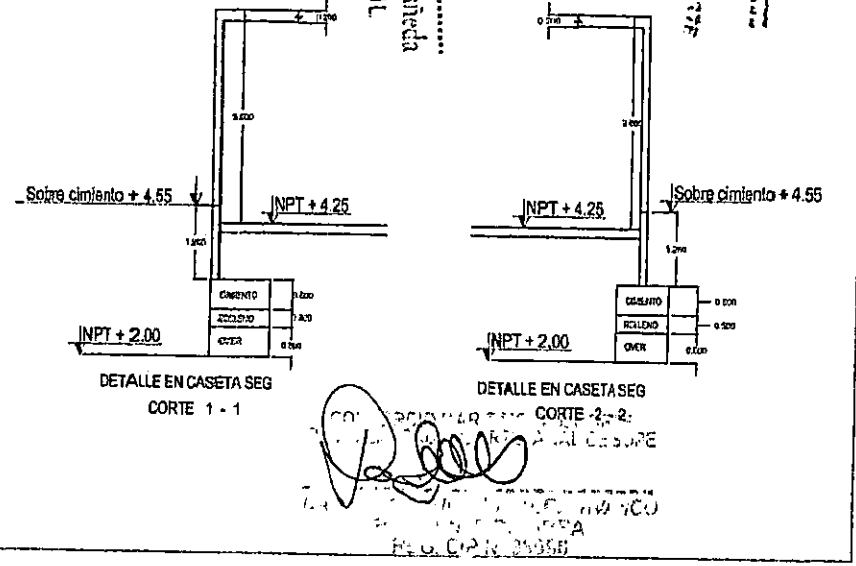

N	NORTE	ESTE
1	8804662.006	199735.645
2	8804660.125	199737.367
3	8804658.673	199735.781
4	8804660.504	199734.005
5	8804662.255	199739.693

7a-609

000190

CASETA DE SEG

REC: 175

DE ESTRIBI
DETAJI

Ø	r (cm.)	Ø (cm.)
1/2"	2.5	12.5
3/8"	2.0	10.0
1/4"	1.3	6.5

Especificado

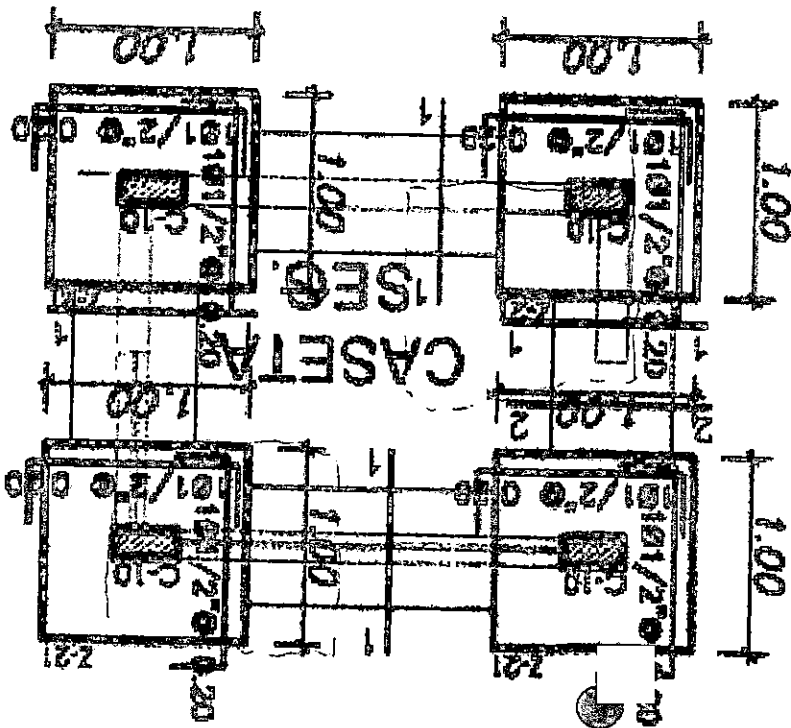
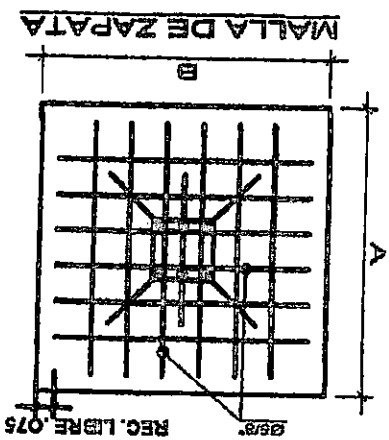

CUADRO DE COLUMNAS

TIPO	FERRO.	ESTRIBOS.	SECCION
C-1	4x3/8"	Ø 3/8" 20.05, 20.10, 20.15, Rto.20 c/o.	
C-9	4x3/8"	Ø 3/8" 20.05, 20.10, 20.15, Rto.20 c/o.	
C-10	4x1/2"	Ø 3/8" 20.05, 20.10, 20.15, Rto.20 c/o.	
C-11	4x3/8"	Ø 3/8" 20.05, 20.10, 20.15, Rto.20 c/o.	

NOTA: La ubicación de las zapatas ven en el detalle topográfico.

[Signature]
LUDWIG CARRASCO BUSTAMANTE
Ing. Supervisor - CIP 78040
CESEL S.A.

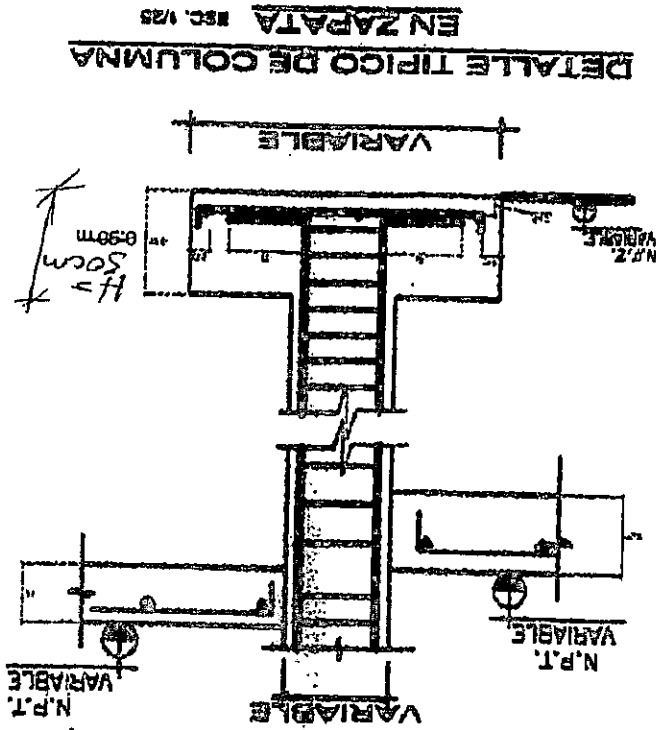

[Signature]
GRAYAN CALINDO VEGA
CONTROL DE CALIDAD
CORPORACION SINGULI MARITIMO

SINGULI MARITIMO DEL NORTE
INGENIERO ARQUITECTO
CIP N° 10446
RESIDENTE DE CIP N° 10446
REC. CIP N° 98

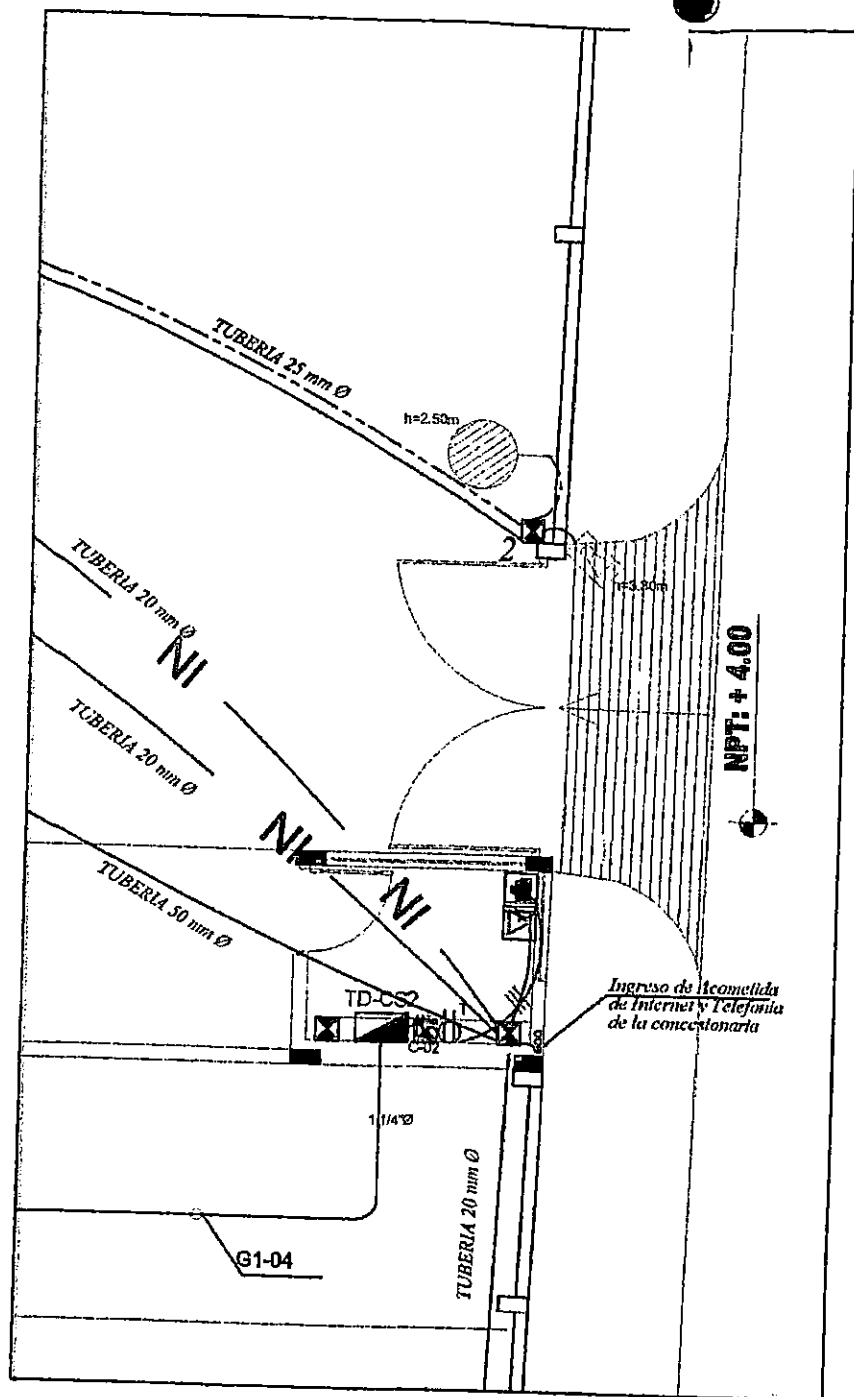

	TUBERIA PVC-P 20 mmØ EMPOTRADA EN PARED O TECHO PARA VOZ Y DATA.
	TUBERIA PVC-P 25 mmØ EMPOTRADA EN PARED O TECHO PARA PERIFONEO
	TUBERIA PVC-P 25 mmØ EMPOTRADA EN PARED O TECHO PARA VIDEO CAMARA
	TUBERIA PVC-P 50 mmØ EMPOTRADA EN PARED O TECHO PARA DETECTOR DE HUMO
	TUBERIAS PVC-P 25 mmØ EMPOTRADAS EN PISO

C-02 TOMACORRIENTES
 2x20A 2x25-30mA 1x4mm2(F)+1x4mm2(N)+1x4mm2(T), NH-80 - PVC-SAP 20 mmØ
 10KA

Galindo
 BRAYA GALINDO VEGA
 CONTROL DE CALIDAD
 CONSORCIO MARITIMO DEL NORTE

CONSORCIO MARITIMO DEL NORTE
 DEBE REGISTRAR EN EL REGISTRO DE
 DISEÑOS Y PLANEACIONES DE SU DE
 DISEÑO Y PLANEACIONES DE SU DE
 RESOLUCION N° 000000
 REG. CIP N° 95000

B09-08
 000289



PROYECTO:
**MEJORAMIENTO Y RECUPERACIÓN DE LOS SERVICIOS DEL
DESEMBARCADERO PESQUERO ARTESANAL DE SUPE**

CC275-IVCI -CMN

Elemento:

VACIADO DE CONCRETO EN SUBCIMIENTO

CONTRATISTA: CONSORCIO MARITIMO DEL NORTE		CLIENTE: FONDO NACIONAL DE DESARROLLO PESQUERO - FORDEPES	
FECHA DE VACIADO:		VOLUMEN A VACIAR:	m ³
TIPO DE ESTRUCTURA:		REGISTRA PROBLEMAS:	SI <input type="checkbox"/> NO <input type="checkbox"/> CAUSO:
DOCUMENTOS DE REFERENCIA:	REV. N°	OBSERVACIONES:	
METODO DE VACIADO: SIN BOMBA			
f'c DISEÑO / CEMENTO tipo:	100	SLUMP:	4" - 6" pulgadas
TAM. MAX. AGREGADO:		TEMPERATURA:	°C
TIPO DE ACABADO:		METODO DE CURADO:	AGUA
CHECKLIST PREVIO AL VACIADO		CONTRATISTA	
	CHECK	FECHA	SUPERVISION
Materiales Aprobados (diseños, embebidos, demolidantes, curadores, etc.)	/		
Cambios Aprobados (cambios o modificaciones en elementos a vaciar)	/		
Inspección Topográfica (alineamiento, nivelación, dimensiones, etc.)	/		
Encofrado	/		
Armadura de refuerzo	/		
Limpeza dentro de encofrado	/		
Elementos Embebidos Civiles (anclajes, marcos, etc.)	/		
Elementos Embeb. Mecánicos (pernos de anclajes, tuberías, etc.)	/		
Elementos Embebidos Eléctricos (conduit, red de tierra, etc.)	/		
Elementos Embeb. Sistem. Esp. (conduit, red de tierra, etc.)	/		
Inspección Topográfica de elementos embebidos (alineamiento, nivelación, dimensiones, etc.)	/		
Equipos menores en buen estado (reglas vibratorias, vibradoras de aguja, etc)	/		
Stock de Materiales (curador, lamina polietileno, vigas tipo puente, mantas de yute, rejas, etc)	/		
Otro (especificar):			
PRE-VACIADO VERIFICADO POR	NOMBRE:	SUPERVISION	
	FIRMA:		
Ing. Residente - Contratista			
Vº Bº / Aprobación _____			
CHECKLIST POSTERIOR AL VACIADO		CHECK	FECHA
Inspección Topográfica de elementos vaciados (alineamiento, nivelación, dimensiones, etc.)			
Inspección Topográfica de elementos embebidos (alineamiento, nivelación, dimensiones, etc.)			
Buen acabado en el concreto fresco después de colocado.			
Curado adecuado.			
CONFORME CON REPARACIÓN:		Especificar proceso de reparación:	
SI <input type="checkbox"/> NO <input type="checkbox"/> NO APLICA <input type="checkbox"/>			
COMENTARIOS:			
Responsable de Campo	Seño y Firma: Ing. Luis M. Vera Castañeda INGENIERO CIVIL REG. CIP 140228	Control de Calidad	Seño y Firma: BRAYAN GALINDO VEGA CONTROL DE CALIDAD CONSORCIO MARITIMO DEL NORTE
Residente De Obra	Seño y Firma: DANIEL JUAN MORALES VIVIANO RESIDENTE DE OBRA REG. CIP N° 98098	Supervisor de Obra	Seño y Firma: LUDWING CARRASCO BUSTAMANTE Ing. Supervisor - CIP 79040 CESEL S.A



PROYECTO:
**MEJORAMIENTO Y RECUPERACIÓN DE LOS SERVICIOS DEL
 DESEMBARCADERO PESQUERO ARTESANAL DE SUPE**

000187
 CC275-VCT - CMN
 Elemento:

VACIADO DE CONCRETO EN CIMENTACION

CONTRATISTA: CONSORCIO MARITIMO DEL NORTE		CLIENTE: FONDO NACIONAL DE DESARROLLO PESQUERO - FONDEPES																																																																																
FECHA DE VACIADO:		VOLUMEN A VACIAR: m3																																																																																
TIPO DE ESTRUCTURA:		REGISTRA PROBETAS: SI <input type="checkbox"/> NO <input type="checkbox"/>																																																																																
DOCUMENTOS DE REFERENCIA:		OBSERVACIONES:																																																																																
METODO DE VACIADO: SIN BOMBA		SLUMP: 4" - 6"																																																																																
f'c DISEÑO / CEMENTO tipo: 210 kg/cm2		TEMPERATURA: pulgadas °C																																																																																
TAM. MAX. AGREGADO: pulgadas		METODO DE CURADO: AGUA																																																																																
TIPO DE ACABADO:		CHEKLIST PREVIO AL VACIADO																																																																																
		<table border="1"> <thead> <tr> <th rowspan="2"></th> <th colspan="2">CONTRATISTA</th> <th colspan="2">AGUA SUPERVISION</th> </tr> <tr> <th>CHECK</th> <th>FECHA</th> <th>INICIALES / CHECK</th> <th>FECHA</th> </tr> </thead> <tbody> <tr> <td>Materiales Aprobados (diseños, embebidos, demoldantes, curadores, etc.)</td> <td>/</td> <td></td> <td></td> <td></td> </tr> <tr> <td>Cambios Aprobados (cambios o modificaciones en elementos a vaciar)</td> <td>/</td> <td></td> <td></td> <td></td> </tr> <tr> <td>Inspección Topográfica (alineamiento, nivelación, dimensiones, etc.)</td> <td>/</td> <td></td> <td></td> <td></td> </tr> <tr> <td>Encofrado</td> <td>/</td> <td></td> <td></td> <td></td> </tr> <tr> <td>Armadura de refuerzo</td> <td>/</td> <td></td> <td></td> <td></td> </tr> <tr> <td>Limpieza dentro de encofrado</td> <td>/</td> <td></td> <td></td> <td></td> </tr> <tr> <td>Elementos Embebidos Civiles (anclajes, marcos, etc.)</td> <td>/</td> <td></td> <td></td> <td></td> </tr> <tr> <td>Elementos Embeb. Mecánicos (pernas de anclajes, tuberías, etc.)</td> <td>/</td> <td></td> <td></td> <td></td> </tr> <tr> <td>Elementos Embebidos Eléctricos (conduit, red de tierra, etc.)</td> <td>/</td> <td></td> <td></td> <td></td> </tr> <tr> <td>Elementos Embeb. Sistem. Esp. (conduit, red de tierra, etc.)</td> <td>/</td> <td></td> <td></td> <td></td> </tr> <tr> <td>Inspección Topográfica de elementos embebidos (alineamiento, nivelación, dimensiones, etc.)</td> <td>/</td> <td></td> <td></td> <td></td> </tr> <tr> <td>Equipos menores en buen estado (reglas vibratorias, vibradoras de aguja, etc.)</td> <td>/</td> <td></td> <td></td> <td></td> </tr> <tr> <td>Stock de Materiales (curador, lamina polietileno, vigas tipo puente, mantas de yute, reglas, etc.)</td> <td>/</td> <td></td> <td></td> <td></td> </tr> <tr> <td>Otro (especificar):</td> <td></td> <td></td> <td></td> <td></td> </tr> </tbody> </table>			CONTRATISTA		AGUA SUPERVISION		CHECK	FECHA	INICIALES / CHECK	FECHA	Materiales Aprobados (diseños, embebidos, demoldantes, curadores, etc.)	/				Cambios Aprobados (cambios o modificaciones en elementos a vaciar)	/				Inspección Topográfica (alineamiento, nivelación, dimensiones, etc.)	/				Encofrado	/				Armadura de refuerzo	/				Limpieza dentro de encofrado	/				Elementos Embebidos Civiles (anclajes, marcos, etc.)	/				Elementos Embeb. Mecánicos (pernas de anclajes, tuberías, etc.)	/				Elementos Embebidos Eléctricos (conduit, red de tierra, etc.)	/				Elementos Embeb. Sistem. Esp. (conduit, red de tierra, etc.)	/				Inspección Topográfica de elementos embebidos (alineamiento, nivelación, dimensiones, etc.)	/				Equipos menores en buen estado (reglas vibratorias, vibradoras de aguja, etc.)	/				Stock de Materiales (curador, lamina polietileno, vigas tipo puente, mantas de yute, reglas, etc.)	/				Otro (especificar):				
	CONTRATISTA		AGUA SUPERVISION																																																																															
	CHECK	FECHA	INICIALES / CHECK	FECHA																																																																														
Materiales Aprobados (diseños, embebidos, demoldantes, curadores, etc.)	/																																																																																	
Cambios Aprobados (cambios o modificaciones en elementos a vaciar)	/																																																																																	
Inspección Topográfica (alineamiento, nivelación, dimensiones, etc.)	/																																																																																	
Encofrado	/																																																																																	
Armadura de refuerzo	/																																																																																	
Limpieza dentro de encofrado	/																																																																																	
Elementos Embebidos Civiles (anclajes, marcos, etc.)	/																																																																																	
Elementos Embeb. Mecánicos (pernas de anclajes, tuberías, etc.)	/																																																																																	
Elementos Embebidos Eléctricos (conduit, red de tierra, etc.)	/																																																																																	
Elementos Embeb. Sistem. Esp. (conduit, red de tierra, etc.)	/																																																																																	
Inspección Topográfica de elementos embebidos (alineamiento, nivelación, dimensiones, etc.)	/																																																																																	
Equipos menores en buen estado (reglas vibratorias, vibradoras de aguja, etc.)	/																																																																																	
Stock de Materiales (curador, lamina polietileno, vigas tipo puente, mantas de yute, reglas, etc.)	/																																																																																	
Otro (especificar):																																																																																		
PRE-VACIADO VERIFICADO POR		SUPERVISION																																																																																
NOMBRE: FIRMA:																																																																																		
Ing. Residente - Contratista																																																																																		
VO Bº / Aprobación																																																																																		
CHEKLIST POSTERIOR AL VACIADO																																																																																		
Inspección Topográfica de elementos vaciados (alineamiento, nivelación, dimensiones, etc.)		CHECK	FECHA																																																																															
Inspección Topográfica de elementos embebidos (alineamiento, nivelación, dimensiones, etc.)		CHECK	FECHA																																																																															
Buen acabado en el concreto fresco después de colocado.																																																																																		
Curado adecuado.																																																																																		
CONFORME CON REPARACIÓN: SI <input type="checkbox"/> NO <input type="checkbox"/> NO APLICA <input type="checkbox"/>		Especificar proceso de reparación:																																																																																
NOTA: Dse, a (plano manda concreto f'c = 175 kg/cm ² en cimiento cimiento																																																																																		
COMENTARIOS:																																																																																		
Responsable de Campo	Sello y Firma: Ing. Luis M. Vega Castañeda INGENIERO CIVIL REG. CIP 140228	Control de Calidad	Sello y Firma: BRAYAN GACINDO VEGA CONTROL DE CALIDAD CONSORCIO MARITIMO DEL NORTE																																																																															
Residente de Obra	Sello y Firma: DANIEL TORRES VIGNOLES VIVAS RESIDENTE DE OBRA REG. CIP N° 89993	Supervisor de Obra	Sello y Firma: LUDWING CABASCO BUSTAMANTE Ing. Supervisor - CIP 79040 CESEL S.A.																																																																															



PROYECTO:
**MEJORAMIENTO Y RECUPERACIÓN DE LOS SERVICIOS DEL
 DESEMBARCADERO PESQUERO ARTESANAL DE SUPE**

CC275-IVCI -CMN
 Elemento:

VACIADO DE CONCRETO EN ZAPATA

CONTRATISTA: CONSORCIO MARITIMO DEL NORTE		CLIENTE: FONDO NACIONAL DE DESARROLLO PESQUERO - FONDEPES	
FECHA DE VACIADO:		VOLUMEN A VACIAR:	
TIPO DE ESTRUCTURA:		REGISTRA PRODETAS: m3	
DOCUMENTOS DE REFERENCIA:		SI <input type="checkbox"/> NO <input type="checkbox"/> GRUPO:	
REV. N°		OBSERVACIONES:	
METODO DE VACIADO: SIN BOMBA		SLUMP: 4" - 6"	
Fc DISEÑO / CEMENTO tipo: 210 kg/cm2		TEMPERATURA: pulgadas	
TAM. MAX. AGREGADO: pulgadas		METODO DE CURADO: AGUA	
TIPO DE ACABADO:		AGUA	
CHECKLIST PREVIO AL VACIADO		CONTRATISTA	
		SUPERVISION	
		CHECK	FECHA
		INICIALES / CHECK	FECHA
Materiales Aprobados (discos, embebidos, curadores, etc.)		✓	
Cambios Aprobados (cambios o modificaciones en elementos a vaciar)		✓	
Inspección Topográfica (alineamiento, nivelación, dimensiones, etc.)		✓	
Encofrado		✓	
Armadura de refuerzo		✓	
Limpieza dentro de encofrado		✓	
Elementos Embebidos Civiles (anclajes, marcos, etc.)		✓	
Elementos Embeb. Mecánicos (pernos de anclajes, tuberías, etc.)		✓	
Elementos Embebidos Eléctricos (conduit, red de tierra, etc.)		✓	
Elementos Embeb. Sistem. Esp. (conduit, red de tierra, etc.)		✓	
Inspección Topográfica de elementos embebidos (alineamiento, nivelación, dimensiones, etc.)		✓	
Equipos menores en buen estado (reglas vibratorias, vibradoras de aguja, etc.)		✓	
Stock de Materiales (curador, lamina polietileno, vigas tipo puente, mantas de yute, reglas, etc.)		✓	
Otro (especificar):			
PRE-VACIADO VERIFICADO POR		SUPERVISION	
NOMBRE:			
FIRMA:			
Ing. Residente - Contratista			
Vº Bº / Aprobación			
CHECKLIST POSTERIOR AL VACIADO		CONTRATISTA	
		SUPERVISION	
		CHECK	FECHA
		CHECK	FECHA
Inspección Topográfica de elementos vaciados (alineamiento, nivelación, dimensiones, etc.)			
Inspección Topográfica de elementos embebidos (alineamiento, nivelación, dimensiones, etc.)			
Buen acabado en el concreto fresco después de colocado.			
Curado adecuado.			
CONFORME CON REPARACIÓN: SI <input type="checkbox"/> NO <input type="checkbox"/> NO APLICA <input type="checkbox"/>		Especificar proceso de reparación:	
COMENTARIOS:			
Responsable de Campo	Seño y Firma: Ing. Luis M. Vera Castañeda INGENIERO CIVIL REG. CIP 140228	Control de Calidad	Seño y Firma: BRAYAN GALINDO VEGA CONTROL DE CALIDAD CONSORCIO MARITIMO DEL NORTE
Residente De Obra	Seño y Firma: CONSORCIO MARITIMO DEL NORTE DESEMBARCADERO PESQUERO ARTESANAL DE SUPE DANIEL JOAQUIN MORALES VILLALBA RESIDENTE DE OBRA REG. CIP N° 91115	Supervisor de Obra	Seño y Firma: LUDWIG CARRASCO BUSTAMANTE Ing. Supervisor - CIP 79040 CESEL S.A.



PROYECTO:
**MEJORAMIENTO Y RECUPERACIÓN DE LOS SERVICIOS DEL
 DESEMBARCADERO PESQUERO ARTESANAL DE SUPE**

CC275-IVC/ -CMN

Elemento:

000185 809-12

VACIADO DE CONCRETO EN SOBRECIMIENTO

CONTRATISTA: CONSORCIO MARITIMO DEL NORTE		CLIENTE: FONDO NACIONAL DE DESARROLLO PESQUERO - FONDEPES	
FECHA DE VACIADO:		VOLUMEN A VACIAR:	m3
TIPO DE ESTRUCTURA:		REGISTRA PROBETAS:	SI <input type="checkbox"/> NO <input type="checkbox"/> GRUPO:
DOCUMENTOS DE REFERENCIA:	REV. N°	OBSERVACIONES:	
METODO DE VACIADO: SIN BOMBA			
Fc DISEÑO / CEMENTO tipo: <i>ATS</i>	kg/cm2	SLUMP:	4" - 6" pulgades
TAM. MAX. AGREGADO:	pulgadas	TEMPERATURA:	°C
TIPO DE ACABADO:		METODO DE CURADO:	AGUA
CHECKLIST PREVIO AL VACIADO		CONTRATISTA	
		CHECK	FECHA
		SUPERVISION	
		INICIALES / CHECK	FECHA
Materiales Aprobados (diseños, embebidos, demoldantes, curadores, etc)		/	
Cambios Aprobados (cambios o modificaciones en elementos a vaciar)		/	
Inspección Topográfica (alineamiento, nivelación, dimensiones, etc.)		/	
Encofrado		/	
Armadura de refuerzo		/	
Limpieza dentro de encofrado		/	
Elementos Embebidos Civiles (anclajes, marcos, etc.)		/	
Elementos Embeb. Mecánicos (pernos de anclajes, tuberías, etc.)		/	
Elementos Embebidos Eléctricos (conduit, red de tierra, etc.)		/	
Elementos Embeb. Sistem. Esp. (conduit, red de tierra, etc.)		/	
Inspección Topográfica de elementos embebidos (alineamiento, nivelación, dimensiones, etc.)		/	
Equipos menores en buen estado (reglas vibratorias, vibradoras de aguja, etc)		/	
Stock de Materiales (curador, lamina polietileno, vigas tipo puente, mantas de yute, reglas, etc)		/	
Otro (especificar):			
PRE-VACIADO VERIFICADO POR	NOMBRE:	SUPERVISION	
	FIRMA:		
Ing. Residente - Contratista			
Vº Bº / Aprobación _____			
CHECKLIST POSTERIOR AL VACIADO		CHECK	FECHA
Inspección Topográfica de elementos vaciados (alineamiento, nivelación, dimensiones, etc.)			
Inspección Topográfica de elementos embebidos (alineamiento, nivelación, dimensiones, etc.)			
Buen acabado en el concreto fresco después de colocado.			
Curado adecuado.			
CONFORME CON REPARACIÓN: SI <input type="checkbox"/> NO <input type="checkbox"/> NO APLICA <input checked="" type="checkbox"/>		Especificar proceso de reparación:	
<i>Nota - Antes de vaciar el sobrecimiento, tiene que existir conformidad del Ing. electricista del Contratista validando ubicación de tuberías</i>			
COMENTARIOS:			
Responsable de Campo	Seño y Firma: Ing. Luis M. Vera Castañeda INGENIERO CIVIL REG CIP 14022F	Control de Calidad	Seño y Firma: BRAYAN GALINDO VEGA CONTROL DE CALIDAD CONSORCIO MARITIMO DEL NORTE
Residente de Obra	Seño y Firma: DANIEL JOAQUÍN MORALES VIQUECO RESIDENTE DE OBRA REG. CIP N° 6095	Supervisor de Obra	Seño y Firma:

3

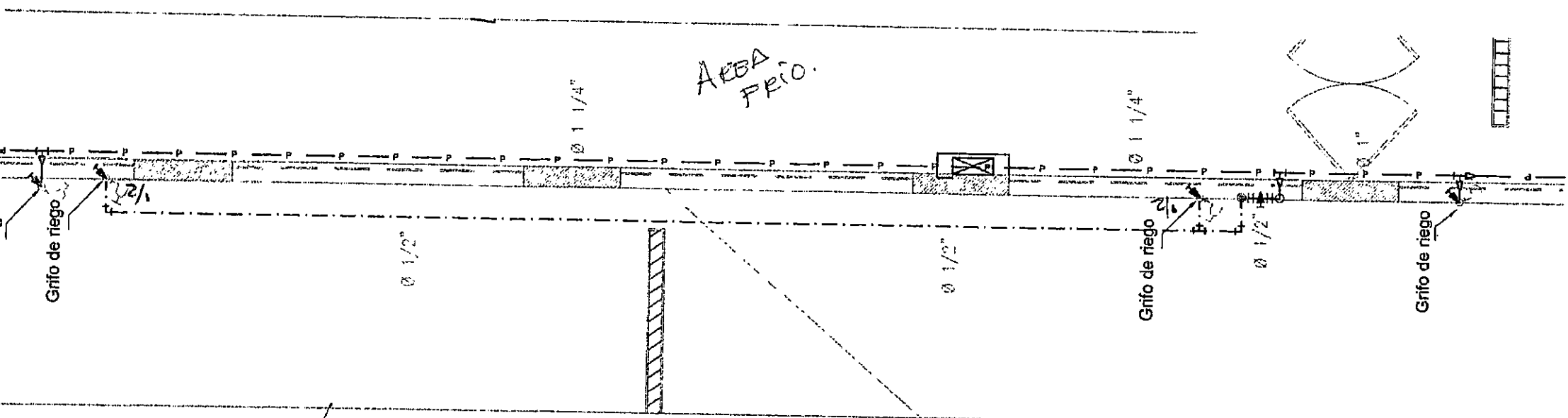

G.L.
 BRAYLEY
 CONSTRUCTORA S.A.

CONSORCIO MARITIMO DEL NORTE
 DESEMBARCADERO ARICA MARITIMO
 DANIEL JOAQUIN MORAN
 RESIDENTE DE OBRAS
 REG. CIP N° 5000

Ing. Luis M. Vera Castañeda
 INGENIERO CIVIL
 R.C. C.P. 140208

ING. PEDRO MUCHA RAE
 CESEL S.A.
 SUPERVISOR DE OBRAS
 000284

Bloque 06

000183

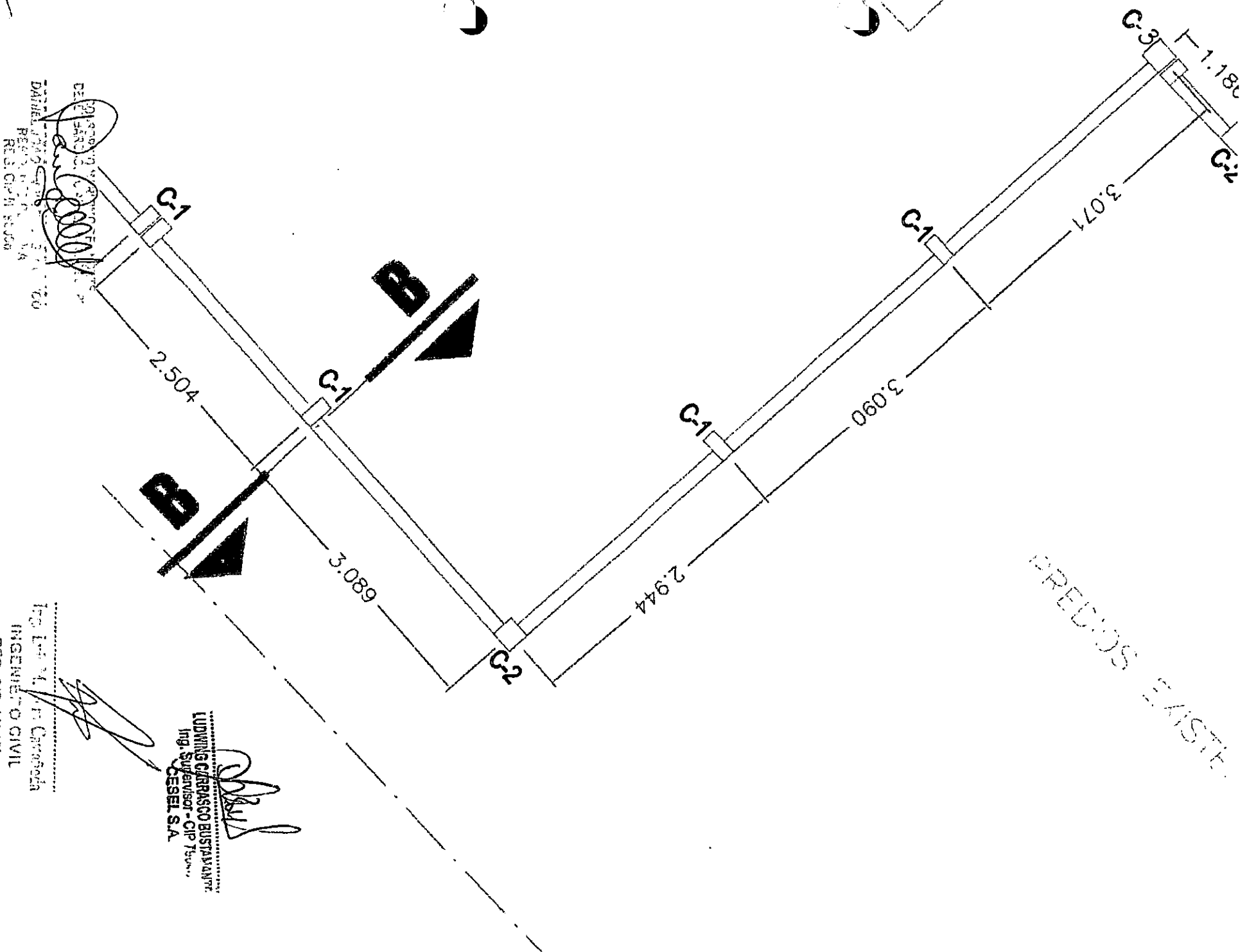

PRECIOS EXISTE



DANIEL JAVIER REYES CIP M 140229

Ing. Ludwig Carasco
INGENIERO CIVIL
REG. CIP 140229

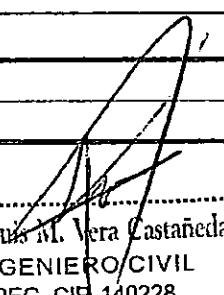
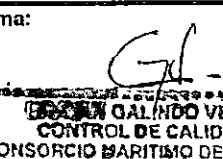
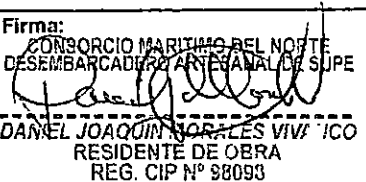
LUDWIG CARASCO BUSTAMANTE
Ing. Supervisor - CIP Titular
CESEI S.A.

		CONTROL DE ALBAÑILERIA ASENTADO DE LADRILLO TIPO IV		CC275-RCAI -CMN	
CLIENTE: FONDO NACIONAL DE DESARROLLO PESQUERO - FONDEPES		REGISTRADO:		FECHA: 01-02-19	
CONTRATISTA: CONSORCIO MARITIMO DEL NORTE		OBRA: MEJORAMIENTO Y RECUPERACION DE LOS SERVICIOS DEL DESEMBARCADERO PESQUERO ARTESANAL DE SUPE		FECHA: 01-02-19	
Elemento: Muro de Cerco		Código de Tabique:			
Area Asentada (m2):		Fecha del Asentado: 01-02-19			
Etapa:		Revisión			
Documentos de Referencia		Revisión		Observaciones	
Lista de Verificación Previa al Asentado (Ver Plano de Detalle)		FECHA	CONTRATISTA	SUPERVISION	CONFORMIDAD
Trazo definido		01-02-19			
Espesor de juntas definido		01-02-19			
Alineamiento		01-02-19			
Refuerzo		01-02-19			
Autorización para el Asentado		01-02-19			
Ladrillo (humedecido)		31-02-19			
Inicio de Asentado		01-02-19			
SUPERVISOR CALIDAD:		Fecha:		CONFORMIDAD	
Lista de Verificación Posterior al Asentado		FECHA	CONTRATISTA	SUPERVISION	CONFORMIDAD
Variación: <input type="checkbox"/> Vertical <input type="checkbox"/> Nivel <input type="checkbox"/> Juntas asentado					
Verificación de Verticalidad					
Verificación de Refuerzos					
Elementos Embebidos: Anclajes		<input type="checkbox"/> Acero <input type="checkbox"/> Mecanica <input type="checkbox"/> Sanitaria <input type="checkbox"/> Electricos			
Huecos de limpieza clausurados					
Corte de Mortero de Juntas al ras					
Comentarios:					
Responsable Campo	Sello y Firma:  Ing. Luis M. Vera Castañeda INGENIERO CIVIL REG. CIP 140228		Control de Calidad	Sello y Firma:  DANIEL CALINDO VEGA CONTROL DE CALIDAD CONSORCIO MARITIMO DEL NORTE	
Residente de Obra	Sello y Firma: CONSORCIO MARITIMO DEL NORTE DESEMBARCADERO ARTESANAL DE SUPE  DANIEL JOAQUIN MORALES VIVERO RESIDENTE DE OBRA REG. CIP Nº 98093		Supervisor de Obra	Sello y Firma:  LUDWIG CARRASCO BUSTAMANTE Ing. Supervisor - CIP 79040 CESEL S.A.	

000181



PROYECTO:
**MEJORAMIENTO Y RECUPERACIÓN DE LOS SERVICIOS DEL
DESEMBARCADERO PESQUERO ARTESANAL DE SUPE**

CC275-JVC/ -GMN

Elemento:

VACIADO DE CONCRETO EN COLUMNETAS

CONTRATISTA: CONSORCIO MARITIMO DEL NORTE		CLIENTE: FONDO NACIONAL DE DESARROLLO PESQUERO - FONDEPES	
FECHA DE VACIADO:		VOLUMEN A VACIAR: m3	
TIPO DE ESTRUCTURA:		REGISTRA PROBETAS: SI <input checked="" type="checkbox"/> NO <input type="checkbox"/>	
DOCUMENTOS DE REFERENCIA:		REVISIÓN N.º	
REV. N.º		OBSERVACIONES:	
METODO DE VACIADO: SIN BOMBA		SLUMP: 4" - 6" pulgadas	
Fc DISEÑO / CEMENTO tipo: kg/cm2		TEMPERATURA: °C	
TAM. MAX. AGREGADO: pulgadas		METODO DE CURADO: AGUA	
TIPO DE ACABADO:		AGUA	
CHECKLIST PREVIO AL VACIADO		CONTRATISTA	
		SUPERVISION	
		CHECK	FECHA
		INICIALES / CHECK	FECHA
Materiales Aprobados (diseños, embebidos, demoldantes, curadores, etc.)		/	
Cambios Aprobados (cambios o modificaciones en elementos a vaciar)		/	
Inspección Topográfica (alineamiento, nivelación, dimensiones, etc.)		/	
Encofrado		/	
Armadura de refuerzo		/	
Limpieza dentro de encofrado		/	
Elementos Embebidos Civiles (anclajes, marcos, etc.)		-	
Elementos Embeb. Mecánicos (pernos de anclajes, tuberías, etc.)		-	
Elementos Embebidos Eléctricos (conduit, red de tierra, etc.)		-	
Elementos Embeb. Sistem. Esp. (conduit, red de tierra, etc.)		-	
Inspección Topográfica de elementos embebidos (alineamiento, nivelación, dimensiones, etc.)		/	
Equipos menores en buen estado (reglas vibratorias, vibradoras de aguja, etc.)		/	
Stock de Materiales (curador, lamina polietileno, vigas tipo puente, mantas de yute, reglas, etc.)		/	
Otro (especificar):		-	
PRE-VACIADO VERIFICADO POR		SUPERVISION	
NOMBRE:			
FIRMA:			
Ing. Residente - Contratista			
Vº Bº / Aprobación			
CHECKLIST POSTERIOR AL VACIADO		CONTRATISTA	
		SUPERVISION	
		CHECK	FECHA
		CHECK	FECHA
Inspección Topográfica de elementos vaciados (alineamiento, nivelación, dimensiones, etc.)			
Inspección Topográfica de elementos embebidos (alineamiento, nivelación, dimensiones, etc.)			
Buen acabado en el concreto fresco después de colocado.			
Curado adecuado.			
CONFORME CON REPARACIÓN: SI <input type="checkbox"/> NO <input type="checkbox"/> NO APLICA <input type="checkbox"/>		Especificar proceso de reparación:	
COMENTARIOS:			
Responsable de Campo	Sello y Firma: Ing. Iván A. Cabada INGENIERO CIVIL REG. CIP 140228	Control de Calidad	Sello y Firma: BRYAN GALINDO VEGA CONTROL DE CALIDAD CONSORCIO MARITIMO DEL NORTE
Residente De Obra	Sello y Firma: LUDWIG CARRASCO BUSTAMANTE Ing. Supervisor - CIP 79040 CESEL S.A.	Supervisor de Obra	Sello y Firma: LUDWIG CARRASCO BUSTAMANTE Ing. Supervisor - CIP 79040 CESEL S.A.



PROYECTO: MEJORAMIENTO Y RECUPERACIÓN DE LOS SERVICIOS DEL DESEMBARCADERO PESQUERO ARTESANAL DE SUPE

CCZ75-IECTC/ -CMN
REGISTRO:

INSPECCIÓN DE ENCOFRADO

Contratista:	CONSORCIO MARITIMO DEL NORTE	Fecha:	
Cliente:	FONDO NACIONAL DE DESARROLLO PESQUERO - FONDEPES	Documentos de referencia:	
Ubicación:			
Tipo de estructura:			

ESQUEMA DEL ENCOFRADO:

Grificar el elemento, identificar ubicación por ejes, puntualizar detalles del encofrado

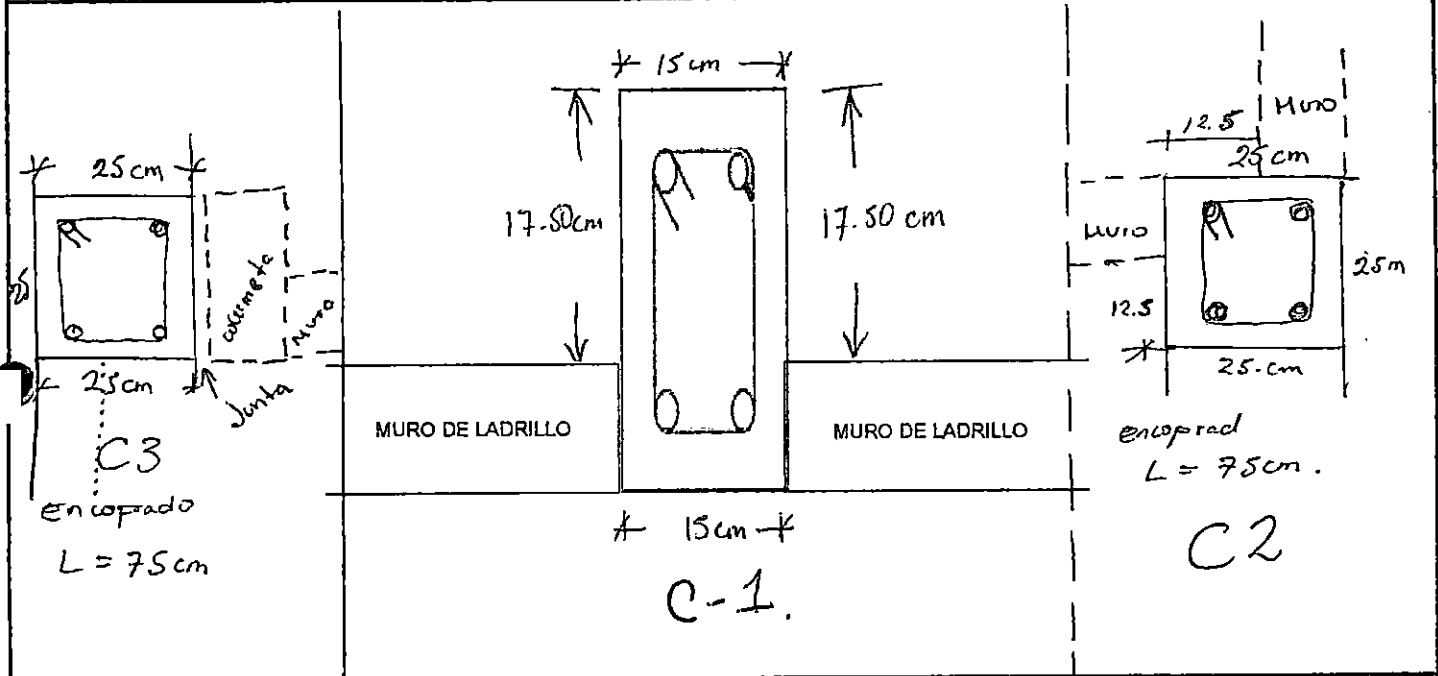

DATOS DIMENSIONALES (mm):

PUNTOS PLOMADA									
ARRIBA									
ABAJO									
DESVIACION									

CHECKLIST DEL ENCOFRADO:

	CHECKLIST DEL ENCOFRADO:				COMENTARIOS
	CONFORME	NO CONFORME	NO APLICA	REPARADO/CO RREGIDO	
Material del encofrado	///				
Condición del encofrado	///				
Compleja de formas del encofrado	///				
Forma y dimensiones del encofrado	///				
Aplicación de desmoldante	///				
Aseguramiento de soleras	///				
Apuntalamiento y fijación	///				
Hermeticidad del encofrado	///				
Fecha de desencofrado	///				

COMENTARIOS / OBSERVACIONES GENERALES:

Responsable de Campo:	Sello y Firma: Ing. Luis M. Vera Camacho INGENIERO CIVIL REG. CIP 140228	Control de Calidad:	Sello y Firma: INGENIERO CIVIL GALINDO VEGA CONTROL DE CALIDAD CONSORCIO MARITIMO DEL NORTE
Residente de Obra:	Sello y Firma: LUDWING CARRASCO BUSTAMANTE ING. SUPERVISOR - CIP 79040 CFSEI C	Supervisor de Obra:	Sello y Firma: LUDWING CARRASCO BUSTAMANTE ING. SUPERVISOR - CIP 79040 CFSEI C



INSPECCION DE ACERO DE REFUERZO

000179
CC275-IAR/ -CMN

CLIENTE:	FONDO NACIONAL DE DESARROLLO PESQUERO - FONDEPES	REGISTRO:
CONTRATISTA:	CONSORCIO MARITIMO DEL NORTE	
OBRA:	MEJORAMIENTO Y RECUPERACIÓN DE LOS SERVICIOS DEL DESEMBARCADERO PESQUERO ARTESANAL DE SUPE	FECHA:

UBICACION:	DOCUMENTOS DE REFERENCIA:
SECTOR:	
T. ESTRUCTURA:	

ESQUEMA DE LA ARMADURA: Graficar el elemento, identificar ubicación por ejes, puntualizar detalles del acero.

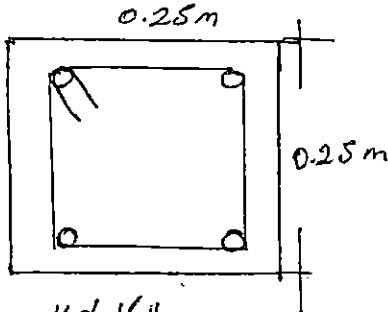

4φ 1/2"
 □ 3/8" 1@0.05. 6@10
 2@0.15 R@25
 C2-C3.

CHECKLIST DEL ACERO DE REFUERZO

	CONFORME	NO CONFORME	NO APLICA	REPARADO/CORREGIDO	COMENTARIOS
Limpieza (corrosión, concreto, grasa)	/				
Calidad del acero (Norma ASTM, grado, marca)	/				
Diámetro de varilla	/				
Longitud de traslape	/				
Longitud de gancho	/				
Espaciamiento entre barras	/				
Espaciamiento de estribos	/				
Alambre de amarro	/				
Soportes para recubrimiento contra base	/				
Soportes para recubrimiento lateral	/				
Verticalidad (plomada)	/				
Horizontalidad (nivel)	/				

COMENTARIOS / OBSERVACIONES GENERALES:

Responsable de Campo:	Sello y Firma: Ing. Dr. M. V. Catañeda INGENIERO CIVIL REG. CIP 140228	Control de Calidad:	Sello y Firma: BRAYAN GALINDO VEGA CONTROL DE CALIDAD CONSORCIO MARITIMO DEL NORTE
	Residente de Obra:		Sello y Firma: LUDWIG CARRASCO BUSTAMANTE Ing. Supervisor - CIP 79040 CESEL S.A.

"Decenio de la Igualdad de Oportunidad para Mujeres y Hombres"
"Año del Diálogo y Reconciliación Nacional"

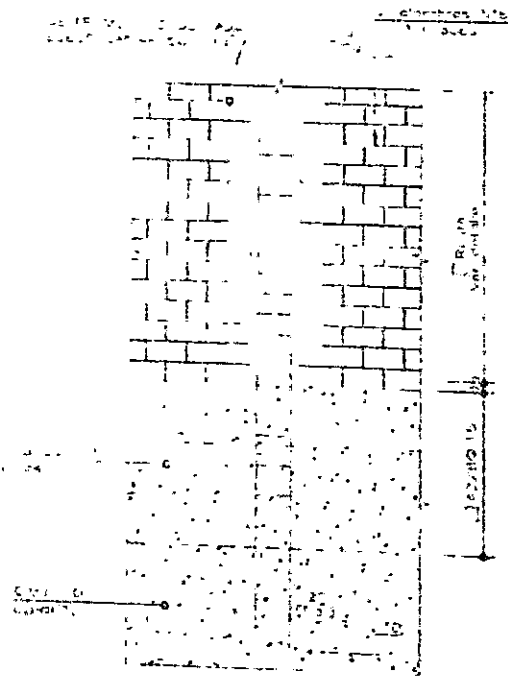
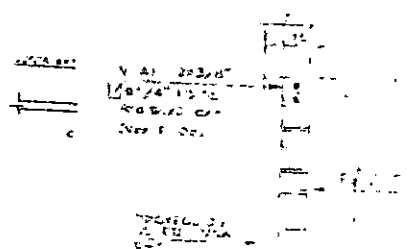
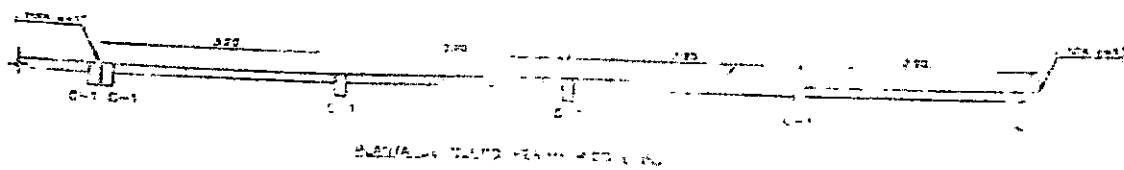

ANÁLISIS DE COLUMNAS
EN MUROS DE ALBAÑILERÍA
ESCALA 1/20



Gabinely

[Signature]
DISEÑO
DAME
REC...

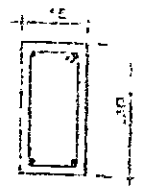

20' 72"
10' 10"
C-1
ESCALA 1/20

[Signature]

Figura 3: Cerco Perimétrico propuesto



PROYECTO: MEJORAMIENTO Y RECUPERACIÓN DE LOS SERVICIOS DEL DESEMBARCADERO PESQUERO ARTESANAL DE SUPE

000177
 CC275-IECTC/ -CMN
 REGISTRO:

INSPECCION DE ENCOFRADO

Contratista:	CONSORCIO MARITIMO DEL NORTE	Fecha:	
Ciente:	FONDO NACIONAL DE DESARROLLO PESQUERO - FONDEPES	Documentos de referencia:	
Ubicación:			
Tipo de estructura:			

ESQUEMA DEL ENCOFRADO:

Graficar el elemento, identificar ubicación por ejes, puntualizar detalles del encofrado



13 cm

Estructura: 12.5cm x 13 cm

Arquitectura: 15cm x 15 cm

12.5 cm

DATOS DIMENSIONALES (mm):

PUNTOS PLOMADA									
ARRIBA									
ABAJO									
DESVIACION									

CHECKLIST DEL ENCOFRADO:

	CONFORME	NO CONFORME	NO APLICA	REPARADO/CO RREGIDO	COMENTARIOS
Material del encofrado	/				
Condición del encofrado	/				
Empieza de formas del encofrado	/				
Forma y dimensiones del encofrado	/				
Aplicación de desmoldante	/				
Aseguramiento de soleras	/				
Apuntalamiento y fijación	/				
Hermeticidad del encofrado	/				
Fecha de desencofrado	/				

COMENTARIOS / OBSERVACIONES GENERALES:

Responsable de Campo:	Sello y Firma: Ing. Gabriel Vega INGENIERO CIVIL REG. CIP 140228	Control de Calidad:	Sello y Firma: BRAYAN SEGUNDO VEGA CONTROL DE CALIDAD CONSORCIO MARITIMO DEL NORTE
Residente de Obra:	Sello y Firma: DAMIÁN CARRASCO BUSTAMANTE RESIDENTE DE OBRA REG. CIP N. 30030	Supervisor de Obra:	Sello y Firma: LUDWIG CARRASCO BUSTAMANTE Ing. Supervisor - CIP 79040 CESEL S.A.

000176



PROYECTO:
**MEJORAMIENTO Y RECUPERACIÓN DE LOS SERVICIOS DEL
DESEMBARCADERO PESQUERO ARTESANAL DE SUPE**

CC275-IVC/ -CMN
Elemento:

VACIADO DE CONCRETO EN VIGA

CONTRATISTA: CONSORCIO MARITIMO DEL NORTE		CLIENTE: FONDO NACIONAL DE DESARROLLO PESQUERO - FONDEPES	
FECHA DE VACIADO:		VOLUMEN A VACIAR: m3	
TIPO DE ESTRUCTURA:		REGISTRA PROBETAS: SI NO GRUPO:	
DOCUMENTOS DE REFERENCIA:		REV. N°	
METODO DE VACIADO: SIN BOMBA		SLUMP: 4" - 6" pulgadas	
Fc DISEÑO / CEMENTO tipo: kn/cm2		TEMPERATURA: °C	
TAM. MAX. AGREGADO: pulgadas		METODO DE CURADO: AGUA	
TIPO DE ACABADO:		CONTRATISTA	
CHECKLIST PREVIO AL VACIADO		SUPERVISION	
	CHECK	FECHA	INICIALES / CHECK
Materiales Aprobados (diseños, embebidos, demoldantes, curadores, etc.)	/		
Cambios Aprobados (cambios o modificaciones en elementos a vaciar)	/		
Inspección Topográfica (alineamiento, nivelación, dimensiones, etc.)	/		
Encofrado	/		
Armadura de refuerzo	/		
Limpieza dentro de encofrado	/		
Elementos Embebidos Civiles (anclajes, marcos, etc.)	/		
Elementos Embeb. Mecánicos (pernos de anclajes, tuberías, etc.)	/		
Elementos Embebidos Eléctricos (conduit, red de tierra, etc.)	/		
Elementos Embeb. Sistem. Esp. (conduit, red de tierra, etc.)	/		
Inspección Topográfica de elementos embebidos (alineamiento, nivelación, dimensiones, etc.)	/		
Equipos menores en buen estado (reglas vibratorias, vibradoras de aguja, etc.)	/		
Stock de Materiales (curador, lamina polietileno, vigas tipo puente, mantas de yute, reglas, etc.)	/		
Otro (especificar):			
PRE-VACIADO VERIFICADO POR	NOMBRE:	SUPERVISION	
	FIRMA:		
Ing. Residente - Contratista			
Vº Bº / Aprobación			
CHECKLIST POSTERIOR AL VACIADO		CHECK	FECHA
Inspección Topográfica de elementos vaciados (alineamiento, nivelación, dimensiones, etc.)			
Inspección Topográfica de elementos embebidos (alineamiento, nivelación, dimensiones, etc.)			
Buen acabado en el concreto fresco después de colocado.			
Curado adecuado.			
CONFORME CON REPARACIÓN: SI <input type="checkbox"/> NO <input type="checkbox"/> NO APLICA <input type="checkbox"/>		Especificar proceso de reparación:	
COMENTARIOS:			
Responsable de Campo		Control de Calidad	
Sello y Firma: Ing. Luis A. V. Casanova INGENIERO CIVIL REG. CIP. 140228		Sello y Firma: BRAYAN GALINDO VEGA CONTROL DE CALIDAD CONSORCIO MARITIMO DEL NORTE	
Residente De Obra		Supervisor de Obra	
Sello y Firma: LUDWING CARRASCO BUSTAMANTE Ing. Supervisor - CIP 79040 CESEL S.A.			



CONTROL DE CALIDAD

INSPECCION DE TARRAJEOS Y DERRAMES

NOMBRE DEL PROYECTO: MEJORAMIENTO Y RECUPERACIÓN DE LOS SERVICIOS DEL DESEMBARCADERO PESQUERO ARTESANAL DE SUPE

FECHA:

CLIENTE: FONDO NACIONAL DE DESARROLLO PESQUERO - FONDEPES

SECTOR:

CONTRATISTA: CONSORCIO MARITIMO DEL NORTE

AREA:

Verificaciones Generales:

Limpeza

Rugosidad

Humedad

Ambiente / Eje	Alisamiento de muros		Verticalidad de muros		Uniformidad de muros		Taraqueo Catinado de Muro		Encuentro cielo raso-muro tipo Media Caja		Verticalidad de derrame		Contrazocalo sanitario		Dimensiones de vanos		Cieloraso	
	C	FECHA	C	FECHA	C	FECHA	C	FECHA	C	FECHA	C	FECHA	C	FECHA	C	FECHA	C	FECHA
Muro (Interior)	/		/		/		/											
Muro (Exterior)	/		/		/		/											
Columnada	/		/		/		/											
Wig ceda	/		/		/		/											
derrame.	/																	

OBSERVACIONES:

CONTROL DE CALIDAD Firma y sello: BRAYAN GALINDO VEGA CONTROL DE CALIDAD COMISIÓN MARITIMA DEL NORTE	RESPONSABLE DE CASO Firma y sello: Lic. L. M. V. Castañeda INGENIERO CIVIL REG. CIP 140228	RESIDENTE DE OBRA Firma y sello: REG. CIP N. 56638	SUPERVISIÓN Firma y sello:
---	---	---	--------------------------------------

000175

BLOQUE 05

000174

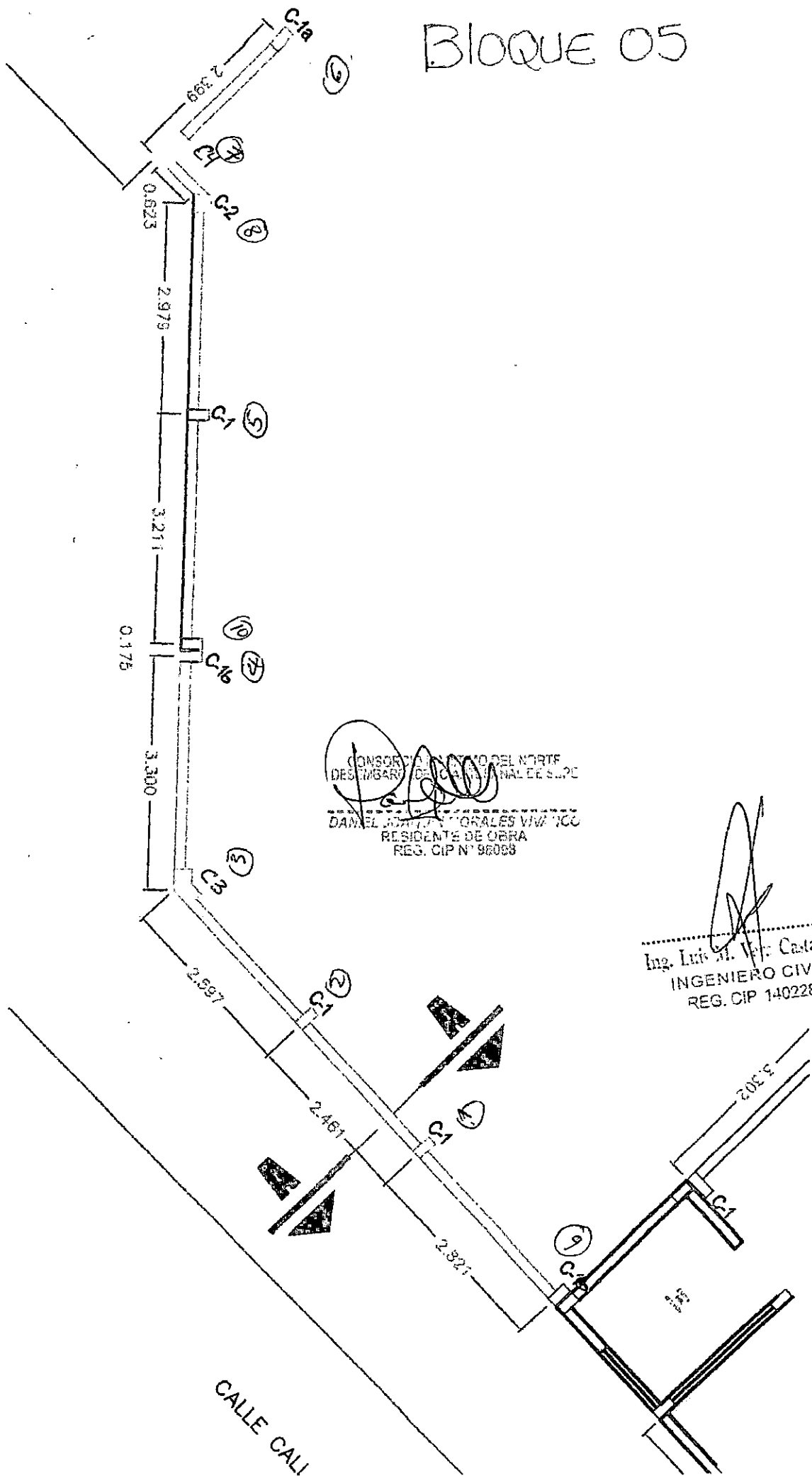

CONSORCIO DEL NORTE
 DESARROLLO DE CALLE CALI DE SURE
 DANIEL RAMÍREZ TORALES VIV. 100
 RESIDENTE DE OBRA
 REG. CIP N° 96068

Ing. Luis M. Vera Castañeda
 INGENIERO CIVIL
 REG. CIP 140228

CALLE CALI



PROYECTO: MEJORAMIENTO Y RECUPERACIÓN DE LOS SERVICIOS DEL DESEMBARCADERO PESQUERO ARTESANAL DE SUPE

CC275-IECTCI -CMN
REGISTRO:

INSPECCION DE ENCOFRADO

Contratista:	CONSORCIO MARITIMO DEL NORTE	Fecha:	21.02.19
Cliente:	FONDO NACIONAL DE DESARROLLO PESQUERO - FONDEPES	Documentos de referencia:	
Ubicación:	bloques (muro de cerco).		
Tipo de estructura:	Columnetas.		

ESQUEMA DEL ENCOFRADO:

Grficar el elemento, identificar ubicación por ejes, puntualizar detalles del encofrado

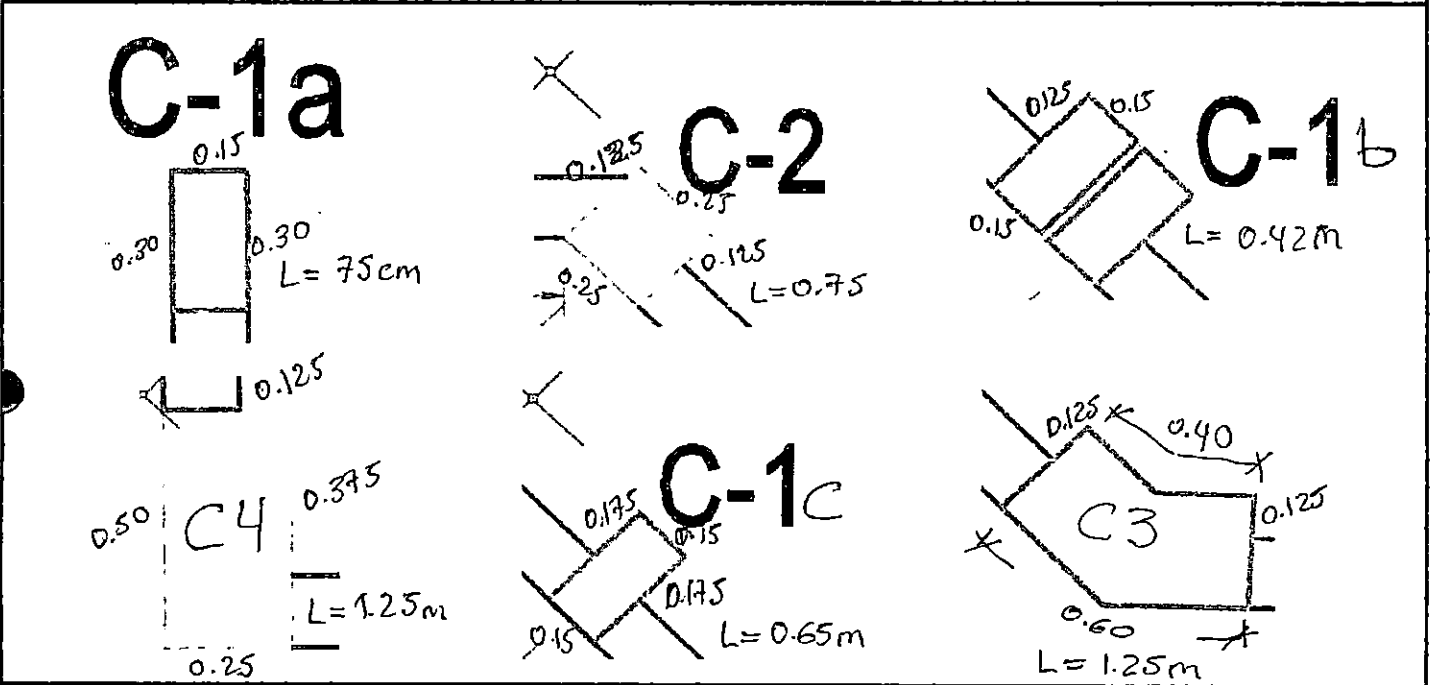

DATOS DIMENSIONALES (mm):	1	2	3	4	5	6
PUNTOS PLOMADA						
ARRIBA	✓	✓	✓	✓	✓	✓
ABAJO						
DESVIACION	Dentro de tolerancia +/- 1 mm.					

CHECLIST DEL ENCOFRADO:

	CONFORME	NO CONFORME	NO APLICA	REPARADO/CO RREGIDO	COMENTARIOS
Material del encofrado	✓				
Condición del encofrado	✓				
Compleza de formas del encofrado	✓				
Forma y dimensiones del encofrado	✓				
Aplicación de desmoldante	✓				
Aseguramiento de soleras	✓				
Apuntalamiento y fijación	✓				
Hermeticidad del encofrado	✓				
Fecha de desencofrado	✓				se mantiene la desunc. 24 hrs.

COMENTARIOS / OBSERVACIONES GENERALES:

Se está liberando con una tolerancia de desviación de +/- 1 mm. Durante colocación de concreto se debe verificar permanentemente que el encofrado mantenga la verticalidad y alineamiento liberado.

Responsable de Campo:	Sello y Firma: 	Control de Calidad:	Sello y Firma:
Residente de Obra:	Sello y Firma: 	Supervisor de Obra:	Sello y Firma:



PROYECTO:
**MEJORAMIENTO Y RECUPERACIÓN DE LOS SERVICIOS DEL
 DESEMBARCADERO PESQUERO ARTESANAL DE SUPE**

000-172
 CC275-IVC/ CMN
 Elemento:

VACIADO DE CONCRETO EN COLUMNETAS

CONTRATISTA: CONSORCIO MARITIMO DEL NORTE		CLIENTE: FONDO NACIONAL DE DESARROLLO PESQUERO - FONDEPES	
FECHA DE VACIADO:		VOLUMEN A VACIAR: m3	
TIPO DE ESTRUCTURA: Columnas		REGISTRA PROJETAS: SI <input checked="" type="checkbox"/> NO <input type="checkbox"/>	
DOCUMENTOS DE REFERENCIA:		REV. N°	
METODO DE VACIADO: SIN BOMBA		TEMPERATURA: °C	
Fc DISEÑO / CEMENTO tipo:		ELUMP: 4" - 6" pulgadas	
TAM. MAX. AGREGADO: pulgadas		METODO DE CURADO: AGUA	
TIPO DE ACABADO:		GRUPO:	
CHECKLIST PREVIO AL VACIADO		CONTRATISTA	
		CHECK	FECHA
		SUPERVISION	
		INICIALES / CHECK	FECHA
Materiales Aprobados (diseños, embebidos, demoldantes, curadores, etc)	/		
Cambios Aprobados (cambios o modificaciones en elementos a vaciar)	/		
Inspección Topográfica (alineamiento, nivelación, dimensiones, etc.)	/		
Encofrado	/		
Armadura de refuerzo	/		
Limpieza dentro de encofrado	/		
Elementos Embebidos Cíviles (anclajes, marcos, etc.)	/		
Elementos Embeb. Mecánicos (pernos de anclajes, tuberías, etc.)	/		
Elementos Embebidos Eléctricos (conduit, red de tierra, etc.)	/		
Elementos Embeb. Sistem. Esp. (conduit, red de tierra, etc.)	/		
Inspección Topográfica de elementos embebidos (alineamiento, nivelación, dimensiones, etc.)	/		
Equipos menores en buen estado (reglas vibratorias, vibradoras de aguja, etc)	/		
Stock de Materiales (curador, lamina polietileno, vigas tipo puente, mantas de yute, reglas, etc)	/		
Otro (especificar):			
PRE-VACIADO VERIFICADO POR		SUPERVISION	
NOMBRE:			
FIRMA:			
Ing. Residente - Contratista			
Vº Bº / Aprobación _____			
CHECKLIST POSTERIOR AL VACIADO		CHECK	
		FECHA	FECHA
Inspección Topográfica de elementos vaciados (alineamiento, nivelación, dimensiones, etc.)			
Inspección Topográfica de elementos embebidos (alineamiento, nivelación, dimensiones, etc.)			
Buen acabado en el concreto fresco después de colocado.			
Curado adecuado.			
CONFORME CON REPARACIÓN: SI <input type="checkbox"/> NO <input type="checkbox"/> NO APLICA <input type="checkbox"/>		Especificar proceso de reparación:	
COMENTARIOS: El concreto a utilizar es f'c = 210 kg/cm ² de acuerdo a las especificaciones de sacaron 04 millones de concreto. Las columnas liberadas se muestran en croquis y paginas al presente.			
Responsable de Campo	Sello y Firma: Ing. Luis Castro Castañeda INGENIERO CIVIL	Control de Calidad	Sello y Firma: EVELYN GALINDO VEGA CONTROL DE CALIDAD CONSORCIO MARITIMO DEL NORTE 21.02.19
Residente De Obra	Sello y Firma: REG. CIP 140228 CONSORCIO MARITIMO DEL NORTE RESIDENTE DE OBRA	Supervisor de Obra	Sello y Firma: ING. PEDRO MUCUNA CESEL S.A. SUPERVISOR DE OBRA



PROYECTO: **MEJORAMIENTO Y RECUPERACIÓN DE LOS SERVICIOS DEL DESEMBARCADERO PESQUERO ARTESANAL DE SUPE**

CC275-IECTC/ -CMN
REGISTRO:

INSPECCION DE ENCOFRADO

Contratista:	CONSORCIO MARITIMO DEL NORTE	Fecha:	
Cliente:	FONDO NACIONAL DE DESARROLLO PESQUERO - FONDEPES	Documentos de referencia:	
Ubicación:			
Tipo de estructura:			

ESQUEMA DEL ENCOFRADO:

Graficar el elemento, identificar ubicación por ejes, puntualizar detalles del encofrado

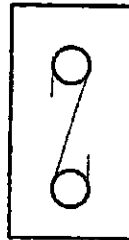

12.5 cm

13 cm

Estructura: 12.5cm x 13 cm

Arquitectura: 15cm x 15 cm

DATOS DIMENSIONALES (mm):

PUNTOS PLOMADA																				
ARRIBA																				
ABAJO																				
DESVIACION																				

CHECULIST DEL ENCOFRADO:

	CONFORME	NO CONFORME	NO APLICA	REPARADO/CO RREGIDO	COMENTARIOS
Material del encofrado	/				
Condición del encofrado	/				
Pieza de formas del encofrado	/				
Forma y dimensiones del encofrado	/				
Aplicación de desmoldante	/				
Aseguramiento de soleras	/				
Apuntalamiento y fijación	/				
Hermeticidad del encofrado	/				
Fecha de desencofrado	/				

COMENTARIOS / OBSERVACIONES GENERALES:

Responsable de Campo:	Sello y Firma: Ing. Luis Alvarado Castañeda INGENIERO CIVIL REG. CIP 140228	Control de Calidad:	Sello y Firma: BRAYÁN GALINDO VEGA CONTROL DE CALIDAD CONSORCIO MARITIMO DEL NORTE
Residente de Obra:	Sello y Firma: RAMÓN MORALES VIQUE RESIDENTE DE OBRA REG. CIP A 35053	Supervisor de Obra:	Sello y Firma: LUDWING CARRASCO BUSTAMANTE Ing. Supervisor - CIP 79040 GESELSA

000170



PROYECTO:
**MEJORAMIENTO Y RECUPERACIÓN DE LOS SERVICIOS DEL
DESEMBARCADERO PESQUERO ARTESANAL DE SUPE**

CC275-IVC/ -CMN
Elemento:

VACIADO DE CONCRETO EN VIGA

CONTRATISTA: CONSORCIO MARITIMO DEL NORTE		CLIENTE: FONDO NACIONAL DE DESARROLLO PESQUERO - FONDEPES	
FECHA DE VACIADO:		VOLUMEN A VACIAR:	m3
TIPO DE ESTRUCTURA:		REGISTRA PROJETAS:	SI NO GRUPO:
DOCUMENTOS DE REFERENCIA:	REV. N°	OBSERVACIONES:	
METODO DE VACIADO: SIN BOMBA		SLUMP: 4" - 6" pulgadas	
Fc DISEÑO / CEMENTO tipo:	kg/cm2	TEMPERATURA:	°C
TAM. MAX. AGREGADO:	pulgadas	METODO DE CURADO: AGUA	
TIPO DE ACABADO:			
CHECKLIST PREVIO AL VACIADO		CONTRATISTA SUPERVISION	
		CHECK	FECHA
		INICIALES / CHECK	FECHA
Materiales Aprobados (diseños, embebidos, demotantes, curadores, etc.)			
Cambios Aprobados (cambios o modificaciones en elementos a vaciar)			
Inspección Topográfica (alineamiento, nivelación, dimensiones, etc.)			
Encofrado			
Armadura de refuerzo			
Limpieza dentro de encofrado			
Elementos Embebidos Civiles (anclajes, marcos, etc.)			
Elementos Embeb. Mecánicos (pernos de anclajes, tuberías, etc.)			
Elementos Embebidos Eléctricos (conduit, red de tierra, etc.)			
Elementos Embeb. Sistem. Esp. (conduit, red de tierra, etc.)			
Inspección Topográfica de elementos embebidos (alineamiento, nivelación, dimensiones, etc.)			
Equipos menores en buen estado (reglas vibratorias, vibradoras de aguja, etc.)			
Stock de Materiales (curador, lamina polietileno, vigas tipo puente, mantas de yute, reglas, etc.)			
Otro (especificar):			
PRE-VACIADO VERIFICADO POR		SUPERVISION	
NOMBRE:			
FIRMA:			
Ing. Residente - Contratista			
Vº Bº / Aprobación			
CHECKLIST POSTERIOR AL VACIADO		CHECK	FECHA
Inspección Topográfica de elementos vaciados (alineamiento, nivelación, dimensiones, etc.)			
Inspección Topográfica de elementos embebidos (alineamiento, nivelación, dimensiones, etc.)			
Buen acabado en el concreto fresco después de colocado.			
Curado adecuado.			
CONFORME CON REPARACIÓN: SI <input type="checkbox"/> NO <input type="checkbox"/> NO APLICA <input type="checkbox"/>		Especificar proceso de reparación:	
COMENTARIOS:			
Responsable de Campo	Sello y Firma: Ing. Luis M. Vera Castañeda INGENIERO CIVIL REG CIP 140228	Control de Calidad	Sello y Firma: BRAYAN GALINDO VEGA CONTROL DE CALIDAD CONSORCIO MARITIMO DEL NORTE
Residente De Obra	Sello y Firma: CONSORCIO MARITIMO DEL NORTE RESIDENTE DE OBRA REG. CIP N° 30390	Supervisor de Obra	Sello y Firma: LUDWIG CARRASCO BUSTAMANTE Ing. Supervisor - CIP 78040 GESEL S.A.

42-505 601000

CONTROL DE CALIDAD

INSPECCION DE TARRAJOS Y DERRAMES

NOMBRE DEL PROYECTO: MEJORAMIENTO Y RECUPERACION DE LOS SERVICIOS DEL DESEMBAUCADERO PESQUERO ARTESANAL DE SUPE
CLIENTE: FONDO NACIONAL DE DESARROLLO PESQUERO - FONDEPES
CONTRATISTA: CONSORCIO MARITIMO DEL NORTE
AREA:

Verificaciones Generales:
 Limpieza Ruidosidad Humedad

Ambiente / Eje	Almacamiento de muros		Verticalidad de muros		Uniformidad de muros		Cubrimiento de muros		Llenado de rasco-trazo tipo Malla Copin		Verticalidad de derrame		Contrazos de escritura		Derivaciones de vientos		Defectos		
	o	c	o	c	o	c	o	c	o	c	o	c	o	c	o	c	o	c	o
Muro (Anduvor)	/	/	/	/	/	/	/	/	/	/	/	/	/	/	/	/	/	/	/
Muro (Exterior)	/	/	/	/	/	/	/	/	/	/	/	/	/	/	/	/	/	/	/
Cuadras	/	/	/	/	/	/	/	/	/	/	/	/	/	/	/	/	/	/	/
Vigas	/	/	/	/	/	/	/	/	/	/	/	/	/	/	/	/	/	/	/
de vane	/	/	/	/	/	/	/	/	/	/	/	/	/	/	/	/	/	/	/

28/02/15 *[Signature]* 28/02/15 *[Signature]*

CONSORCIO MARITIMO DEL NORTE
 Ing. Luis Alvarado
 INGENIERO EN OBRAS
 RES. CIP N. 92308
 Firmado y sellado:

CONSORCIO MARITIMO DEL NORTE
 JOAQUIN MORALES VILA R.C.
 RESIDENTE DE OBRA
 Firmado y sellado:

CONSORCIO MARITIMO DEL NORTE
 Firmado y sellado:

CONSORCIO MARITIMO DEL NORTE
 Firmado y sellado:

Galindo
 BRAVIN GALINDO Y CIA
 CONTROL DE CALIDAD
 CONSORCIO PARTRHO DEL NORTE

[Signature]
 DANIEL JOAQUIN NORRLES VILLAS
 RESIDENTE DE OBRA
 REG. CIP N° 99468
 CONSORCIO PARTRHO DEL NORTE
 DESARROLLO DE OBRAS DE CONSTRUCCION

[Signature]
 Ing. Leonardo Norrles Villalobos
 INGENIERO CIVIL
 REG. CIP 140228



Eje A norte S.
 L = 35.00m (parcial)
 22.02.19
 - excavacion
 - drenaje
 - c. ciclistas

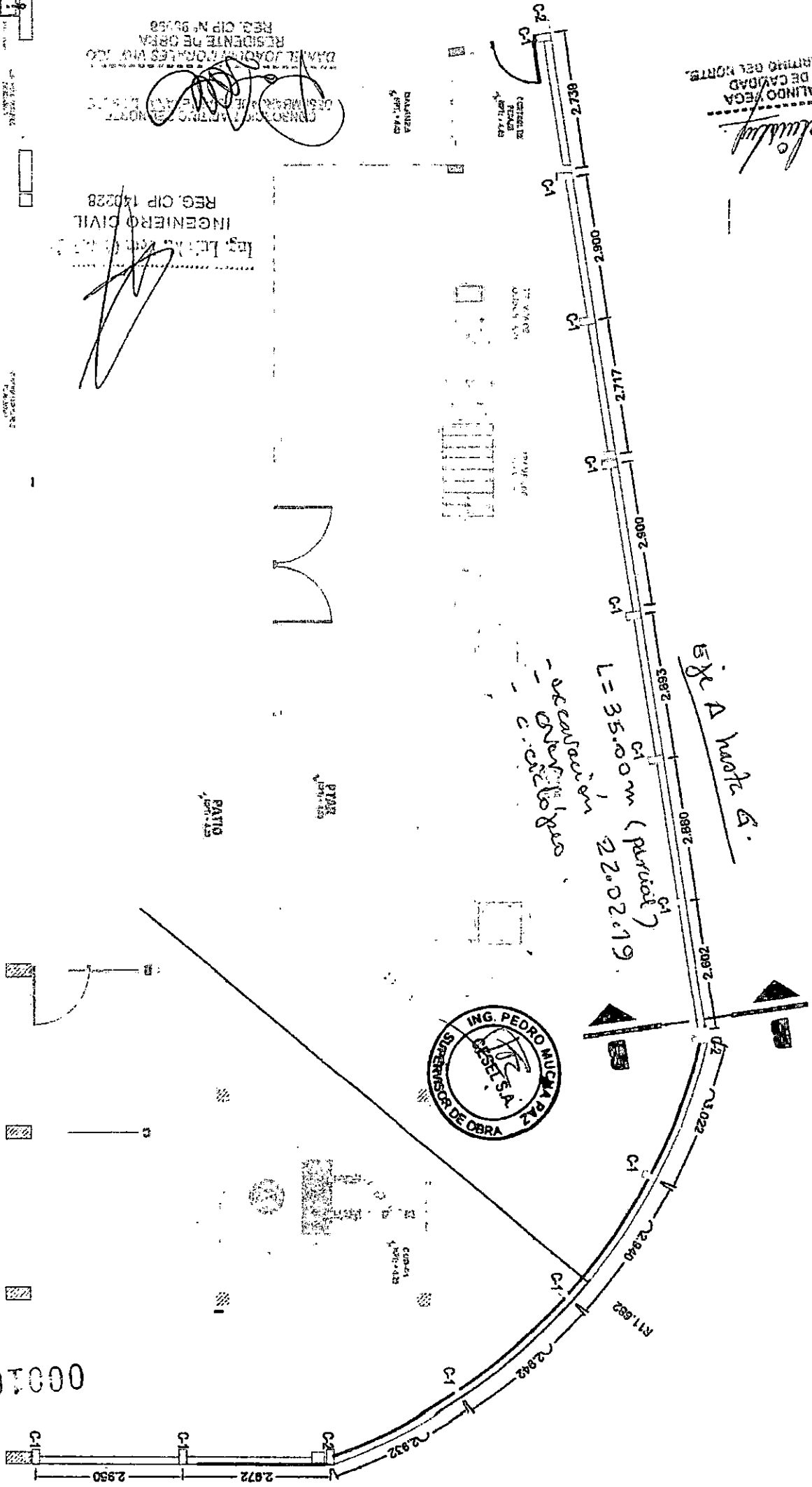

000168

Bloque 11



PROYECTO
**MEJORAMIENTO Y RECUPERACIÓN DE LOS SERVICIOS DEL
 DESEMBARCADERO PESQUERO ARTESANAL DE SUPE**

CC276- CC/ - CMN
 Elemento:

CONTROL DE EXCAVACIONES

CONTRATISTA: **CONSORCIO MARÍTIMO DEL NORTE**

CLIENTE: **FONDO NACIONAL DE DESARROLLO PESQUERO - FONDEPES**

DATOS ESPECÍFICOS

NIVEL/ÁREA/SECTOR: **MURO DE CERCO (PTAR)**

EJES:

MATERIAL: **Afirmado, arena de mar, rocas.**

FECHA: **12/02/19**

DATOS DE ENSAYOS	PLANO
<p>VERIFICACIÓN</p> <p>COTA DE FONDO: + 1.80</p> <p>COTA SUPERIOR: + 3.90</p> <p>ALTURA DE CORTE: 2.10m</p> <p>ÁREA DE CORTE: 31.50 m²</p> <p>VOLUMEN DE EXCAVACION 66.15 m³</p>	
<p>C: CONFORME NC: NO CONFORME</p>	

COMENTARIOS: **longitud medida entre ejes "A" hasta "G", el ancho a considerarse a = 0.90m.**

<p>Responsable Campo</p> <p>Sello y Firma:</p> <p><i>[Signature]</i></p> <p>Ing. León V. Castañeda INGENIERO CIVIL</p>	<p>Control de Calidad</p> <p>Sello y Firma:</p> <p><i>[Signature]</i></p> <p>BRAYAN GALINDO VEGA CONTROL DE CALIDAD CONSORCIO MARITIMO DEL NORTE 12-02-19</p>
<p>Residente de Obra</p> <p>Sello y Firma:</p> <p><i>[Signature]</i></p> <p>ING. PEDRO MUGA CESEL S.A. SUPERVISOR DE OBRA</p>	<p>Supervisor de Obra:</p> <p>Sello y Firma:</p> <p><i>[Signature]</i></p> <p>12.02.19</p>

000166



PROYECTO
**MEJORAMIENTO Y RECUPERACIÓN DE LOS SERVICIOS DEL
 DESEMBARCADERO PESQUERO ARTESANAL DE SUPE**

CC275- CC/ - CMN
 Elemento:

CONTROL DE RELLENO CON PIEDRA OVER

CONTRATISTA: **CONSORCIO MARÍTIMO DEL NORTE**

CLIENTE: **FONDO NACIONAL DE DESARROLLO PESQUERO - FONDEPES**

DATOS ESPECÍFICOS

NIVEL/ÁREA/SECTOR: **MURO DE CERCO (PTAR)**

EJES:

MATERIAL: **PIEDRA OVER**

FECHA: **12/02/19**

DATOS DE ENSAYOS	PLANO
<p>VERIFICACIÓN</p> <p>COTA DE FONDO: +1.00</p> <p>COTA DE RELLENO: +2.30</p> <p>ALTURA DE RELLENO: 0.50m</p> <p>ÁREA DE RELLENO: 31.50 m²</p> <p>Vol = 15.75 m³</p>	
<p>C: CONFORME NC: NO CONFORME</p>	

COMENTARIOS: *Longitud colocada de Over = 35.00m, ancho = 0.90m y 0.50m de altura.*

<p>Responsable Campo</p> <p>Sello y Firma:</p> <p><i>[Signature]</i></p> <p>Ing. Luis A. V. Castañeda INGENIERO CIVIL REG. CIP. 40228</p>	<p>Control de Calidad</p> <p>Sello y Firma:</p> <p><i>[Signature]</i></p> <p>BRAYAN GALINDO VEGA CONTROL DE CALIDAD CONSORCIO MARITIMO DEL NORTE 12-02-19</p>
<p>Residente de Obra</p> <p>Sello y Firma:</p> <p><i>[Signature]</i></p> <p>CONSORCIO MARITIMO DEL NORTE DESSEMBARCADERO PESQUERO ARTESANAL DE SUPE DANIEL MORALES RESIDENTE DE OBRA</p>	<p>Supervisor de Obra:</p> <p>Sello y Firma:</p> <p><i>[Signature]</i></p> <p>ING. PEDRO MUCNA CESEL S.A. SUPERVISOR DE OBRA 12-02-19</p>

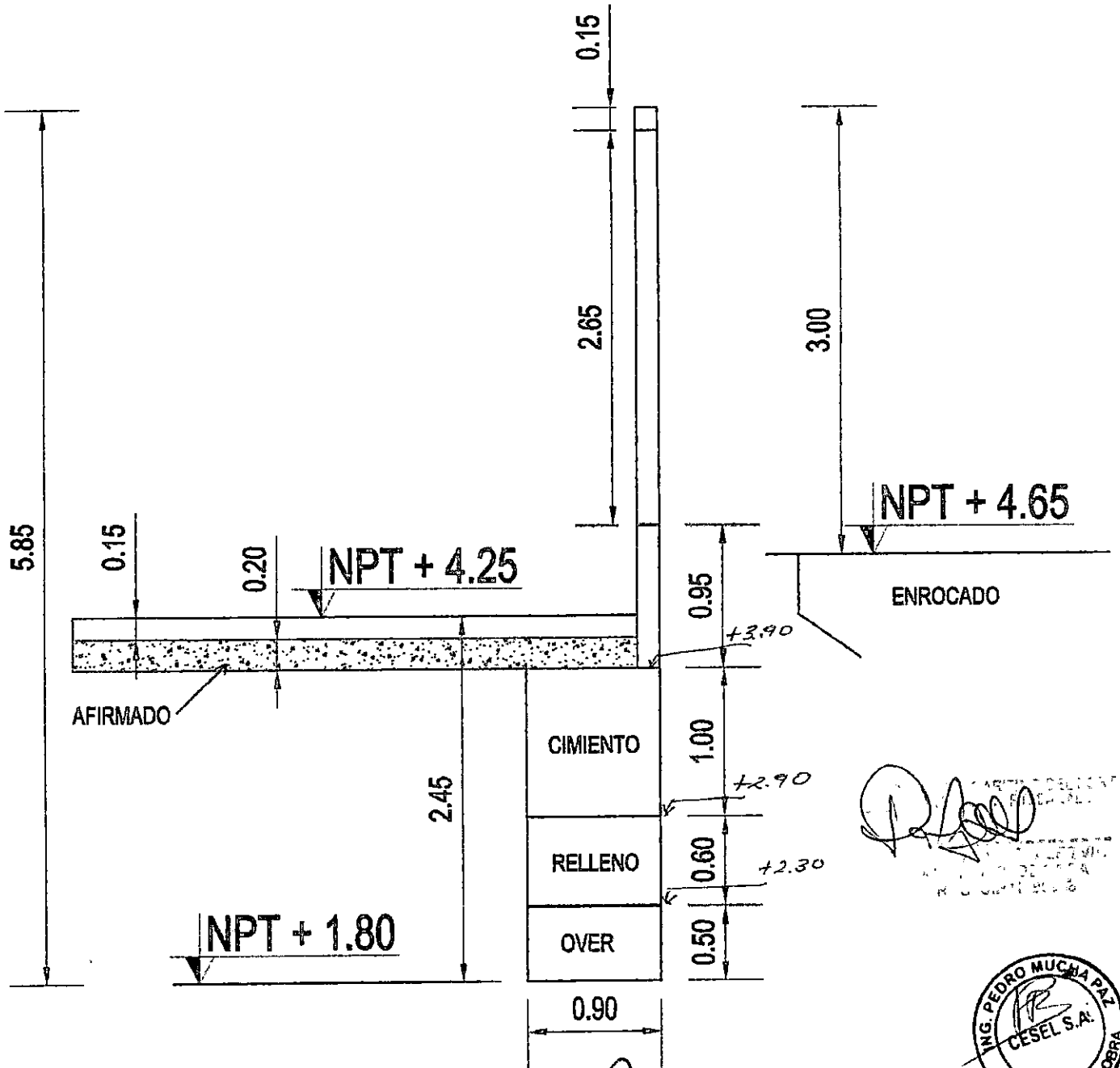

[Handwritten signature]

CONSORCIO MARITIMO DEL NORTE
 CONTROL DE CALIDAD
 NPT + 4.65



DETALLE EN ZONA DE ENROCADO

[Handwritten signature]
 ESTAYAN GALINDO VELA
 CONTROL DE CALIDAD
 CONSORCIO MARITIMO DEL NORTE

[Handwritten signature]
 INGENIERO CIVIL
 CIP 140228

[Handwritten signature]
 LUDWIG CARRASCO BUSTAMANTE
 Ing. Supervisor - CIP 79040
 CESEL S.A.



PROYECTO: MEJORAMIENTO Y RECUPERACIÓN DE LOS SERVICIOS DEL DESEMBARCADERO PESQUERO ARTESANAL DE SUPE

CC 275-ECTC 4-CMN
REGISTRO: 00000004

INSPECCION DE ENCOFRADO EN SUBCIMIENTO, CIMIENTO, SOBRECIMIENTO

Contratista:	CONSORCIO MARITIMO DEL NORTE	Fecha:	
Cliente:	FONDO NACIONAL DE DESARROLLO PESQUERO - FONDEPES	Documentos de referencia:	
Ubicación:			
Tipo de estructura:			

ESQUEMA DEL ENCOFRADO:

Graficar el elemento, identificar ubicación por ejes, puntualizar detalles del encofrado

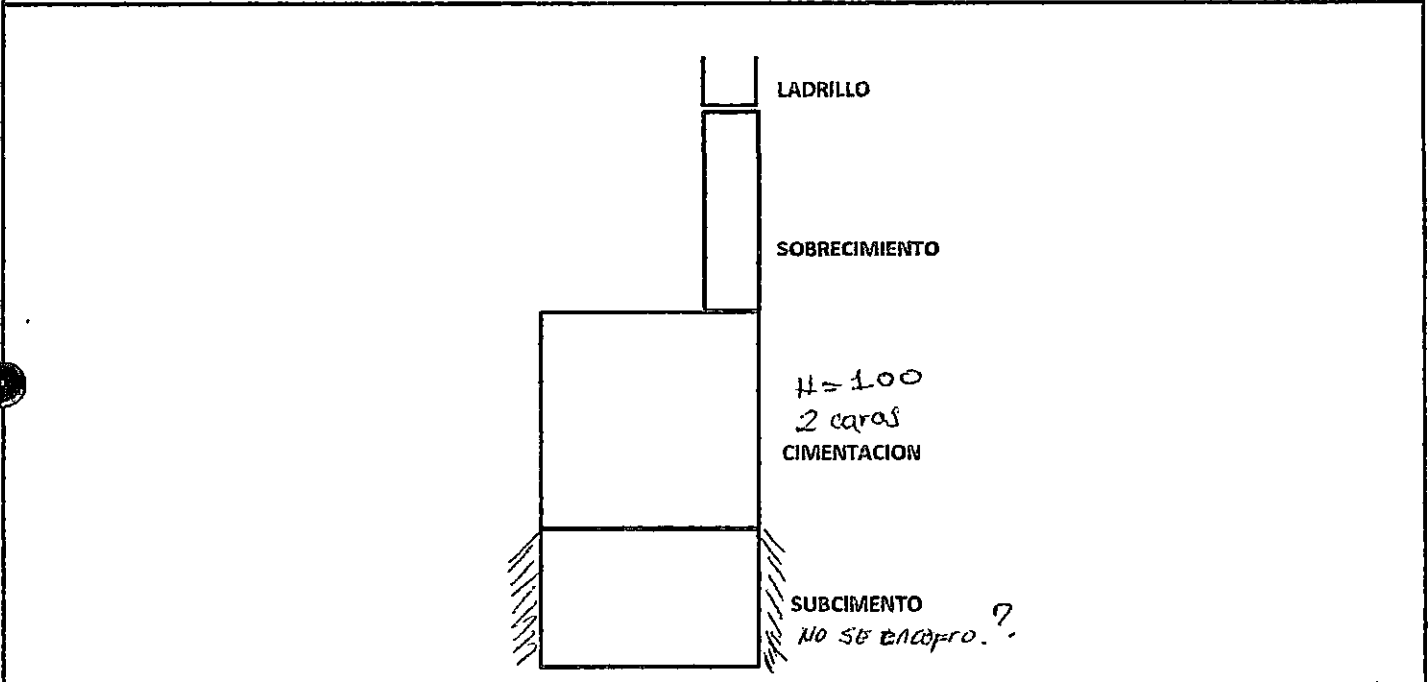

DATOS DIMENSIONALES (mm):

PUNTOS PLOMADA																				
ARRIBA																				
ABAJO																				
DESVIACION																				

CHECKLIST DEL ENCOFRADO:

	CHECKLIST DEL ENCOFRADO:				COMENTARIOS
	CONFORME	NO CONFORME	NO APLICA	REPARADO/CO RREGIDO	
Materia del encofrado	/				
Condición del encofrado	/				
pieza de formas del encofrado	/				
forma y dimensiones del encofrado	/				
Aplicación de desmoldante	/				
Aseguramiento de soleras	/				
Apuntalamiento y fijación	/				
Hermeticidad del encofrado	/				
Fecha de desencofrado	/				

COMENTARIOS / OBSERVACIONES GENERALES:

NOTA: NO SE ENCOFRÓ PERO EL ANCHO FUE DE 1.20.

Responsable de Campo:	Sello y Firma: Ing. Luis M. Vera Castañeda INGENIERO CIVIL REG. CIP 140228	Control de Calidad:	Sello y Firma: BRAYAN GALINDO VEGA CONTROL DE CALIDAD CONSORCIO MARITIMO DEL NORTE
Residente de Obra:	Sello y Firma: CONSORCIO MARITIMO DEL NORTE	Supervisor de Obra:	Sello y Firma:



INSPECCION DE ACERO DE REFUERZO

CC275-IAR/ -CMN

CLIENTE:	FONDO NACIONAL DE DESARROLLO PESQUERO - FONDEPES	REGISTRO:
CONTRATISTA:	CONSORCIO MARÍTIMO DEL NORTE	
OBRA:	MEJORAMIENTO Y RECUPERACIÓN DE LOS SERVICIOS DEL DESEMBARCADERO PESQUERO ARTESANAL DE SUPE	FECHA:

UBICACION:		DOCUMENTOS DE REFERENCIA:
SECTOR:		
T. ESTRUCTURA :		

ESQUEMA DE LA ARMADURA: Graficar el elemento, identificar ubicación por ejes, puntualizar detalles del acero.

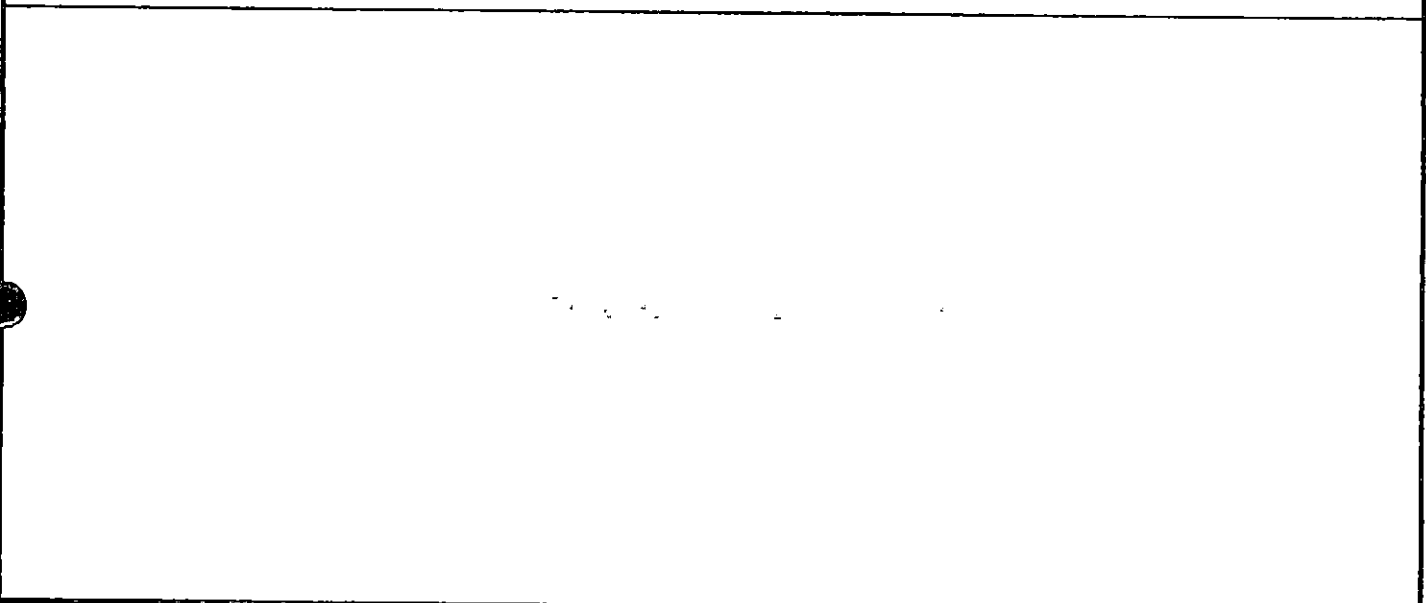

CHECKLIST DEL ACERO DE REFUERZO

	CONFORME	NO CONFORME	NO APLICA	REPARADO/C ORREGIDO	COMENTARIOS
Limpieza (corrosión, concreto, grasa)	/				
Calidad del acero (Norma ASTM, grado, marca)	/				
Diámetro de varilla	/				
Longitud de traslape	/				
Longitud de gancho	/				
Espaciamiento entre barras	/				
Espaciamiento de estribos	/				
Alambre de amarre	/				
Soportes para recubrimiento contra base	/				
Soportes para recubrimiento lateral	/				
Verticalidad (plomada)	/				
Horizontalidad (nivel)	/				

COMENTARIOS / OBSERVACIONES GENERALES:

Responsable de Campo:	Sello y Firma: Ing. Luis M. Vera Castañeda INGENIERO CIVIL REG. CIP 140228	Control de Calidad:	Sello y Firma: BRAYAN GALINDO VEGA CONTROL DE CALIDAD CONSORCIO MARITIMO DEL NORTE
Residente de Obra:	Sello y Firma: 	Supervisor de Obra:	Sello y Firma:

"Decenio de la Igualdad de Oportunidad para Mujeres y Hombres"
"Año del Diálogo y Reconciliación Nacional"

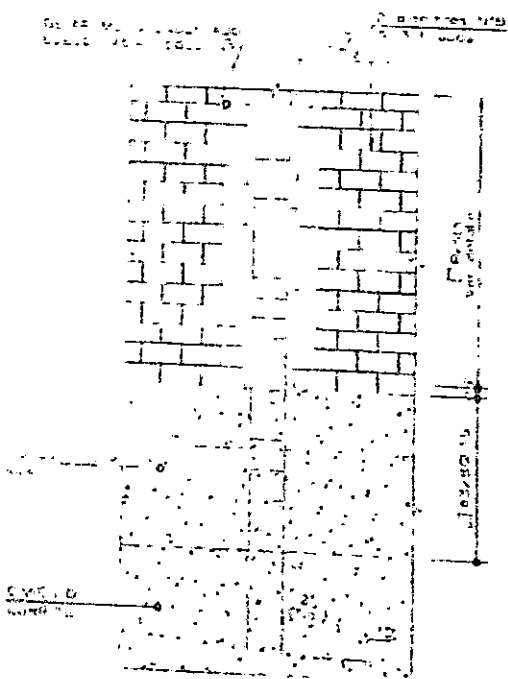
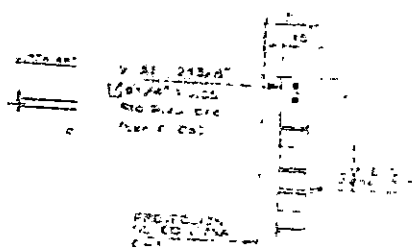
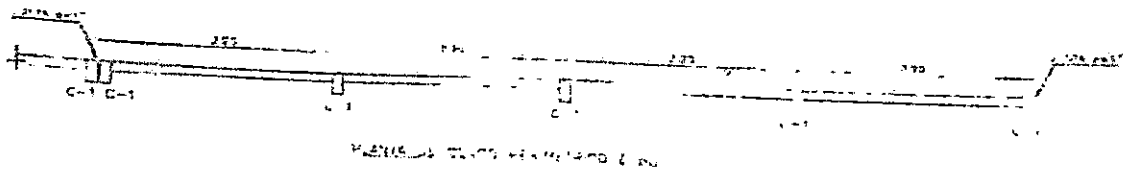

ALICADO ALF. DE COL. IVIAS
EN MUROS DE ALBARRERA
FECHA: 1/75

Galindo
MAYAN GALINDO EGA
CONTROL DE CALIDAD
CONSORCIO MARITIMO DEL NORTE

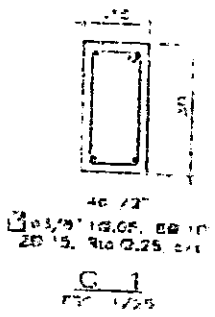

Handwritten signature or initials

Figura 3: Cerco Perimétrico propuesto

Handwritten signature or initials



PROYECTO: MEJORAMIENTO Y RECUPERACIÓN DE LOS SERVICIOS DEL DESEMBARCADERO PESQUERO ARTESANAL DE SUPE

000001
 CC275-REG-01-CMN
 REGISTRO:

INSPECCION DE ENCOFRADO EN COLUMNETA

Contratista:	CONSORCIO MARITIMO DEL NORTE	Fecha:	
Ciente:	FONDO NACIONAL DE DESARROLLO PESQUERO - FONDEPES	Documentos de referencia:	
Ubicación:			
Tipo de estructura:			

ESQUEMA DEL ENCOFRADO:
 Graficar el elemento, identificar ubicación por ejes, puntualizar detalles del encofrado

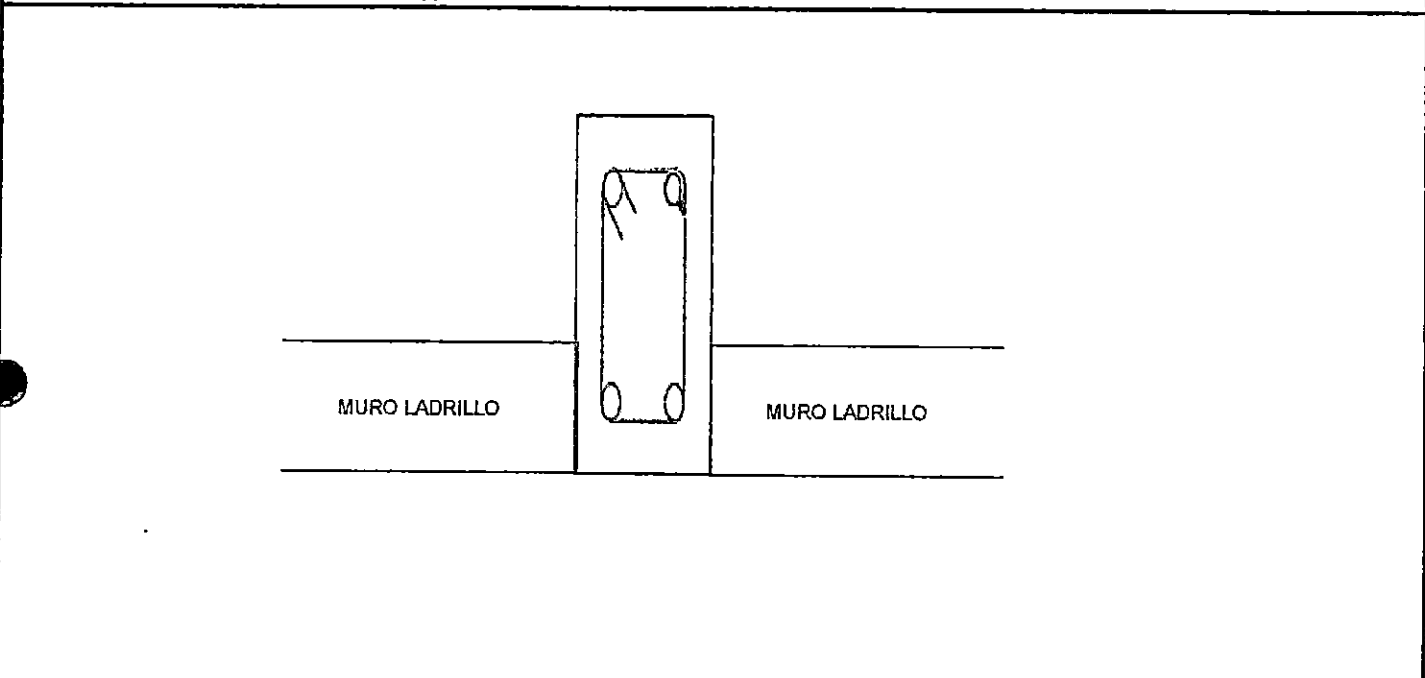

DATOS DIMENSIONALES (mm):

PUNTOS PLOMADA																				
ARRIBA																				
ABAJO																				
DESVIACION																				

CHECKLIST DEL ENCOFRADO:					COMENTARIOS
	CONFORME	NO CONFORME	NO APLICA	REPARADO/CO RREGIDO	
Material del encofrado	/				
Condición del encofrado	/				
pieza de formas del encofrado	/				
Forma y dimensiones del encofrado	/				
Aplicación de desmoldante	/				
Aseguramiento de soleras	/				
Apuntalamiento y fijación	/				
Hermeticidad del encofrado	/				
Fecha de desencofrado	/				

COMENTARIOS / OBSERVACIONES GENERALES:

Responsable de Campo:	Sello y Firma: Ing. Luis M. Vera Castañeda INGENIERO CIVIL REG. CIP 140233	Control de Calidad:	Sello y Firma: BRAYA GALINDO VEGA CONTROL DE CALIDAD CONSORCIO MARITIMO DEL NORTE
Residenta de Obra:	Sello y Firma: CONSORCIO MARITIMO DEL NORTE DESEMBA... BA... REG...	Supervisor de Obra:	Sello y Firma:



PROYECTO:
**MEJORAMIENTO Y RECUPERACIÓN DE LOS SERVICIOS DEL
 DESEMBARCADERO PESQUERO ARTESANAL DE SUPE**

CC275-IVCI -CMN

Elemento:

000260

VACIADO DE CONCRETO EN SUBCIMIENTO

CONTRATISTA: CONSORCIO MARITIMO DEL NORTE		CLIENTE: FONDO NACIONAL DE DESARROLLO PESQUERO - FONDEPES		
FECHA DE VACIADO:	13-02-19	VOLUMEN A VACIAR:	19.00 m3	
TIPO DE ESTRUCTURA:	Subcimiento	REGISTRA PROBETAS:	SI NO X GRUPO:	
DOCUMENTOS DE REFERENCIA:	REV. Nº	OBSERVACIONES:		
METODO DE VACIADO:	SIN BOMBA			
Fc DISEÑO / CEMENTO tipo:	100 kg/cm2	SLUMP:	4" - 6" pulgadas	
TAM. MAX. AGREGADO:	6" pulgadas	TEMPERATURA:	°C	
TIPO DE ACABADO:	Reglado	METODO DE CURADO: AGUA		
CHECKLIST PREVIO AL VACIADO	CONTRATISTA		SUPERVISION	
	CHECK	FECHA	INICIALES / CHECK	FECHA
Materiales Aprobados (diseños, embebidos, demoldantes, curadores, etc.)	/			
Cambios Aprobados (cambios o modificaciones en elementos a vaciar)	/			
Inspección Topográfica (alineamiento, nivelación, dimensiones, etc.)	/			
Encofrado	/			
Armadura de refuerzo	/			
Limpieza dentro de encofrado	/			
Elementos Embebidos Civiles (anclajes, marcos, etc.)	/			
Elementos Embeb. Mecánicos (pernos de anclajes, tuberías, etc.)	/			
Elementos Embebidos Eléctricos (conduit, red de tierra, etc.)	/			
Elementos Embeb. Sistem. Esp. (conduit, red de tierra, etc.)	/			
Inspección Topográfica de elementos embebidos (alineamiento, nivelación, dimensiones, etc.)	/			
Equipos menores en buen estado (reglas vibratorias, vibradoras de aguja, etc.)	/			
Stock de Materiales (curador, lamina polietileno, vigas tipo puente, mantas de yute, reglas, etc.)	/			
Otro (especificar):				
PRE-VACIADO VERIFICADO POR	NOMBRE:	SUPERVISION		
	FIRMA:			
Ing. Residente - Contratista				
Vº Bº / Aprobación				
CHECKLIST POSTERIOR AL VACIADO	CHECK	FECHA	CHECK	FECHA
	Inspección Topográfica de elementos vaciados (alineamiento, nivelación, dimensiones, etc.)			
Inspección Topográfica de elementos embebidos (alineamiento, nivelación, dimensiones, etc.)				
Buen acabado en el concreto fresco después de colocado.				
Curado adecuado.				
CONFORME CON REPARACIÓN:	SI <input type="checkbox"/> NO <input type="checkbox"/> NO APLICA <input checked="" type="checkbox"/>	Especificar proceso de reparación:		
COMENTARIOS:				
de vaciado de concreto a 3 T.A.D, ancho = 0.90m h = 0.60m. a 15.02.19				
Responsable de Campo	Seño y Firma:	Control de Calidad	Seño y Firma:	
	Ing. Luis M. V. Casimiro INGENIERO CIVIL REG. CIP 140222		Galindo Vega BRAYAN GALINDO VEGA CONTROL DE CALIDAD CONSORCIO MARITIMO DEL NORTE 15.02.19	
Residente De Obra	Seño y Firma:	Supervisor de Obra	Seño y Firma:	
	[Firma]		ING. PEDRO MUCAMAZ CESEL S.A. SUPERVISOR DE OBRA 15.02.19	

000159



PROYECTO:
**MEJORAMIENTO Y RECUPERACIÓN DE LOS SERVICIOS DEL
DESEMBARCADERO PESQUERO ARTESANAL DE SUPE**

CC275-IVC/ -CMN

Elemento:

VACIADO DE CONCRETO EN CIMENTACION

CONTRATISTA: CONSORCIO MARITIMO DEL NORTE		CLIENTE: FONDO NACIONAL DE DESARROLLO PESQUERO - FONDEPES			
FECHA DE VACIADO:		VOLUMEN A VACIAR : m3			
TIPO DE ESTRUCTURA :		REGISTRA PROJETAS : SI NO GRUPO:			
DOCUMENTOS DE REFERENCIA:		REV. N°			
METODO DE VACIADO : SIN BOMBA		OBSERVACIONES:			
Fc DISEÑO / CEMENTO tipo : kg/cm2		SLUMP : 4" - 6" pulgadas			
TAM. MAX. AGREGADO : pulgadas		TEMPERATURA : °C			
TIPO DE ACABADO :		METODO DE CURADO : AGUA			
CHECKLIST PREVIO AL VACIADO	CONTRATISTA		SUPERVISION		
	CHECK	FECHA	INICIALES / CHECK	FECHA	
Materiales Aprobados (diseños, embebidos, demolidores, curadores, etc.)	/				
Cambios Aprobados (cambios o modificaciones en elementos a vaciar)	/				
Inspección Topográfica (alineamiento, nivelación, dimensiones, etc.)	/				
Encofrado	/				
Armadura de refuerzo	/				
Limpieza dentro de encofrado	/				
Elementos Embebidos Civiles (anclajes, marcos, etc.)	/				
Elementos Embeb. Mecánicos (pernos de anclajes, tuberías, etc.)	/				
Elementos Embebidos Eléctricos (conduit, red de tierra, etc.)	/				
Elementos Embeb. Sistem. Esp. (conduit, red de tierra, etc.)	/				
Inspección Topográfica de elementos embebidos (alineamiento, nivelación, dimensiones, etc.)	/				
Equipos menores en buen estado (reglas vibratorias, vibradoras de aguja, etc)	/				
Stock de Materiales (curador, lamina polietileno, vigos tipo puente, mantas de yute, reglas, etc)	/				
Otro (especificar):					
PRE-VACIADO VERIFICADO POR	NOMBRE :		SUPERVISION		
	FIRMA :				
Ing. Residente - Contratista					
Vº Bº / Aprobación _____					
CHECKLIST POSTERIOR AL VACIADO		CHECK	FECHA	CHECK	FECHA
Inspección Topográfica de elementos vaciados (alineamiento, nivelación, dimensiones, etc.)					
Inspección Topográfica de elementos embebidos (alineamiento, nivelación, dimensiones, etc.)					
Buen acabado en el concreto fresco después de colocado.					
Curado adecuado.					
CONFORME CON REPARACIÓN:		Especificar proceso de reparación:			
SI <input type="checkbox"/> NO <input type="checkbox"/> NO APLICA <input type="checkbox"/>					
COMENTARIOS:					
Responsable de Campo	Sello y Firma: Ing. Luis M. Vera Castañeda INGENIERO CIVIL REG CIP 140228	Control de Calidad	Sello y Firma: CRISTIAN GALINDO VELA CONTROL DE CALIDAD CONSORCIO MARITIMO DEL NORTE		
Residente De Obra	Sello y Firma: 	Supervisor de Obra	Sello y Firma:		

000158



PROYECTO:
**MEJORAMIENTO Y RECUPERACIÓN DE LOS SERVICIOS DEL
DESEMBARCADERO PESQUERO ARTESANAL DE SUPE**

CC276-IVCI -GMN
Elemento:

VACIADO DE CONCRETO EN SOBRECIMIENTO

CONTRATISTA: CONSORCIO MARITIMO DEL NORTE		CLIENTE: FONDO NACIONAL DE DESARROLLO PESQUERO - FONDEPES	
FECHA DE VACIADO:		VOLUMEN A VACIAR:	m3
TIPO DE ESTRUCTURA:		REGISTRA PROBETAS:	SI NO GRUPO:
DOCUMENTOS DE REFERENCIA:	REV. N°	OBSERVACIONES:	
METODO DE VACIADO: SIN BOMBA			
Fc DISEÑO / CEMENTO Tipo:	kg/cm2	SLUMP:	4" - 6" pulgadas
TAM. MAX. AGREGADO:	pulgadas	TEMPERATURA:	°C
TIPO DE ACABADO:		METODO DE CURADO: AGUA	
CHECKLIST PREVIO AL VACIADO		CONTRATISTA	
		CHECK	FECHA
		SUPERVISION	
		INICIALES / CHECK	FECHA
Materiales Aprobados (diseños, embebidos, demoldantes, curadores, etc.)	/		
Cambios Aprobados (cambios o modificaciones en elementos a vaciar)	/		
Inspección Topográfica (alineamiento, nivelación, dimensiones, etc.)	/		
Encofrado	/		
Armadura de refuerzo	/		
Limpieza dentro de encofrado	/		
Elementos Embebidos Civiles (anclajes, marcos, etc.)	/		
Elementos Embeb. Mecánicos (pernos de anclajes, tuberías, etc.)	/		
Elementos Embebidos Eléctricos (conduit, red de tierra, etc.)	/		
Elementos Embeb. Sistem. Esp. (conduit, red de tierra, etc.)	/		
Inspección Topográfica de elementos embebidos (alineamiento, nivelación, dimensiones, etc.)	/		
Equipos menores en buen estado (reglas vibratorias, vibradoras de aguja, etc.)	/		
Stock de Materiales (curador, lamina polietileno, vigas tipo puente, mantas de yute, reglas, etc.)	/		
Otro (especificar):			
PRE-VACIADO VERIFICADO POR	NOMBRE:	SUPERVISION	
	FIRMA:		
Ing. Residente - Contratista			
Vº Bº / Aprobación			
CHECKLIST POSTERIOR AL VACIADO		CHECK	FECHA
Inspección Topográfica de elementos vaciados (alineamiento, nivelación, dimensiones, etc.)			
Inspección Topográfica de elementos embebidos (alineamiento, nivelación, dimensiones, etc.)			
Buen acabado en el concreto fresco después de colocado.			
Curado adecuado.			
CONFORME CON REPARACIÓN: <input type="checkbox"/> SI <input type="checkbox"/> NO <input type="checkbox"/> NO APLICA <input type="checkbox"/>		Especificar proceso de reparación:	
COMENTARIOS:			
Responsable de Campo	Sello y Firma: Ing. Luis M. Vera Castañeda INGENIERO CIVIL REG CIP 140228	Control de Calidad	Sello y Firma: BRAYN CALINDO VACA CONTR. DE CALIDAD CONSORCIO MARITIMO DEL NORTE
Residente de Obra	Sello y Firma:	Supervisor de Obra	Sello y Firma:

000157



PROYECTO:
**MEJORAMIENTO Y RECUPERACIÓN DE LOS SERVICIOS DEL
DESEMBARCADERO PESQUERO ARTESANAL DE SUPE**

CC275-IVC/ -CMN

Elemento:

VACIADO DE CONCRETO EN COLUMNETAS

CONTRATISTA: CONSORCIO MARITIMO DEL NORTE		CLIENTE: FONDO NACIONAL DE DESARROLLO PESQUERO - FONDEPES	
FECHA DE VACIADO:		VOLUMEN A VACIAR:	m3
TIPO DE ESTRUCTURA:		REGISTRA PROBETAS:	SI NO GRUPO:
DOCUMENTOS DE REFERENCIA:		REV. N°	OBSERVACIONES:
METODO DE VACIADO: SIN BOMBA		SLUMP:	4" - 6" pulgadas
Fc DISEÑO / CEMENTO tipo:		TEMPERATURA:	°C
TAM. MAX. AGREGADO:		METODO DE CURADO:	AGUA
TIPO DE ACABADO:			
CHECKLIST PREVIO AL VACIADO		CONTRATISTA	
		CHECK	FECHA
		SUPERVISION	
		INICIALES / CHECK	FECHA
Materiales Aprobados (diseños, embebidos, demoldantes, curadores, etc.)		/	
Cambios Aprobados (cambios o modificaciones en elementos a vaciar)		/	
Inspección Topográfica (alineamiento, nivelación, dimensiones, etc.)		/	
Encofrado		/	
Armadura de refuerzo		/	
Limpieza dentro de encofrado		/	
Elementos Embebidos Civiles (anclajes, marcos, etc.)		/	
Elementos Embeb. Mecánicos (pernos de anclajes, tuberías, etc.)		/	
Elementos Embebidos Eléctricos (conduit, red de tierra, etc.)		/	
Elementos Embeb. Sistem. Esp. (conduit, red de tierra, etc.)		/	
Inspección Topográfica de elementos embebidos (alineamiento, nivelación, dimensiones, etc.)		/	
Equipos menores en buen estado (reglas vibratorias, vibradoras de aguja, etc)		/	
Stock de Materiales (curador, lamina polietileno, vigas tipo puente, mantas de yute, reglas, etc)		/	
Otro (especificar):			
PRE-VACIADO VERIFICADO POR		NOMBRE:	SUPERVISION
		FIRMA:	
Ing. Residente - Contratista			
Vº Bº / Aprobación _____			
CHECKLIST POSTERIOR AL VACIADO		CHECK	FECHA
Inspección Topográfica de elementos vaciados (alineamiento, nivelación, dimensiones, etc.)			
Inspección Topográfica de elementos embebidos (alineamiento, nivelación, dimensiones, etc.)			
Buen acabado en el concreto fresco después de colocado.			
Curado adecuado.			
CONFORME CON REPARACIÓN:		Especificar proceso de reparación:	
SI <input type="checkbox"/> NO <input type="checkbox"/> NO APLICA <input type="checkbox"/>			
COMENTARIOS:			
Responsable de Campo	Sello y Firma: Ing. Luis M. Ver. Castañeda INGENIERO CIVIL REG. CIP/140228	Control de Calidad	Sello y Firma: BRAVO GALINDO VEGA CONTROL DE CALIDAD CONSORCIO MARITIMO DEL NORTE
Residente De Obra	Sello y Firma: 	Supervisor de Obra	Sello y Firma:



PROYECTO: MEJORAMIENTO Y RECUPERACIÓN DE LOS SERVICIOS DEL DESEMBARCADERO PESQUERO ARTESANAL DE SUPE

000156
 CC275-IECTCI -CMN
 REGISTRO:

INSPECCION DE ENCOFRADO

Contratista:	CONSORCIO MARITIMO DEL NORTE	Fecha:	
Cliente:	FONDO NACIONAL DE DESARROLLO PESQUERO - FONDEPES	Documentos de referencia:	
Ubicación:			
Tipo de estructura:			

ESQUEMA DEL ENCOFRADO:

Graficar el elemento, identificar ubicación por ejes, puntualizar detalles del encofrado

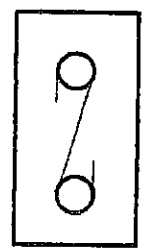

Estructura: 12.5cm x 13 cm
 Arquitectura: 15cm x 15 cm

DATOS DIMENSIONALES (mm):

PUNTOS PLOMADA																				
ARRIBA																				
ABAJO																				
DESVIACION																				

CHECKLIST DEL ENCOFRADO:

	CONFORME	NO CONFORME	NO APLICA	REPARADO/CO RREGIDO	COMENTARIOS
Material del encofrado	/				
Condición del encofrado	/				
Pieza de formas del encofrado	/				
Forma y dimensiones del encofrado	/				
Aplicación de desmoldante	/				
Aseguramiento de soleras	/				
Apuntalamiento y fijación	/				
Hermeticidad del encofrado	/				
Fecha de desencofrado	/				

COMENTARIOS / OBSERVACIONES GENERALES:

Responsable de Campo:	Sello y Firma: Ing. Luis M. Vera Cabañero INGENIERO CIVIL	Control de Calidad:	Sello y Firma: BRAYAN GALINDO VEGA CONTROL DE CALIDAD CONSORCIO MARITIMO DEL NORTE
Residente de Obra:	Sello y Firma: REG. CIP. 140228 MARITIMO DEL NORTE	Supervisor de Obra:	Sello y Firma:



PROYECTO:
**MEJORAMIENTO Y RECUPERACIÓN DE LOS SERVICIOS DEL
 DESEMBARCADERO PESQUERO ARTESANAL DE SUPE**

CC275-IVCJ -CMN

000155

Elemento:

VACIADO DE CONCRETO EN VIGA

CONTRATISTA: CONSORCIO MARITIMO DEL NORTE		CLIENTE: FONDO NACIONAL DE DESARROLLO PESQUERO - FONDEPES	
FECHA DE VACIADO:		VOLUMEN A VACIAR: m3	
TIPO DE ESTRUCTURA:		REGISTRA PROBETAS: SI NO GRUPO:	
DOCUMENTOS DE REFERENCIA:		REV. N°	
METODO DE VACIADO: SIN BOMBA		METODO DE CURADO: AGUA	
Fc DISEÑO / CEMENTO tipo: kg/cm2		SLUMP: 4" - 6" pulgadas	
TAM. MAX. AGREGADO: pulgadas		TEMPERATURA: °C	
TIPO DE ACABADO:		METODO DE CURADO: AGUA	
CHECKLIST PREVIO AL VACIADO		CONTRATISTA	
		SUPERVISION	
		CHECK	FECHA
		INICIALES / CHECK	FECHA
Materiales Aprobados (diseños, embebidos, demoldantes, curadores, etc)		/	
Cambios Aprobados (cambios o modificaciones en elementos a vaciar)		/	
Inspección Topográfica (alineamiento, nivelación, dimensiones, etc.)		/	
Encofrado		/	
Armadura de refuerzo		/	
Limpieza dentro de encofrado		/	
Elementos Embebidos Civiles (anclajes, marcos, etc.)		/	
Elementos Embeb. Muecánicos (pernos de anclajes, tuberías, etc.)		/	
Elementos Embebidos Eléctricos (conduit, red de tierra, etc.)		/	
Elementos Embeb. Sistem. Esp. (conduit, red de tierra, etc.)		/	
Inspección Topográfica de elementos embebidos (alineamiento, nivelación, dimensiones, etc.)		/	
Equipos menores en buen estado (reglas vibratorias, vibradoras de aguja, etc)		/	
Stock de Materiales (curador, lamina polietileno, vigas tipo puente, mantas de yute, reglas, etc)		/	
Otro (especificar):			
PRE-VACIADO VERIFICADO POR		SUPERVISION	
NOMBRE:			
FIRMA:			
Ing. Residente - Contratista			
Vº Bº / Aprobación			
CHECKLIST POSTERIOR AL VACIADO		CONTRATISTA	
		SUPERVISION	
		CHECK	FECHA
		CHECK	FECHA
Inspección Topográfica de elementos vaciados (alineamiento, nivelación, dimensiones, etc.)			
Inspección Topográfica de elementos embebidos (alineamiento, nivelación, dimensiones, etc.)			
Buen acabado en el concreto fresco después de colocado.			
Curado adecuado.			
CONFORME CON REPARACIÓN: SI <input type="checkbox"/> NO <input type="checkbox"/> NO APLICA <input type="checkbox"/>		Especificar proceso de reparación:	
COMENTARIOS:			
Responsable de Campo	Sello y Firma: Ing. Luis M. Vera Castañeda INGENIERO CIVIL REG. CIP 140238	Control de Calidad	Sello y Firma: BRAYAN GALINDO VEGA CONTROL DE CALIDAD CONSORCIO MARITIMO DEL NORTE
Residente De Obra	Sello y Firma: [Firma]	Supervisor de Obra	Sello y Firma:



CONTROL DE CALIDAD

INSPECCION DE TARRAJEOS Y DERRAMES

NOMBRE DEL PROYECTO: MEJORAMIENTO Y RECUPERACIÓN DE LOS SERVICIOS DEL DESENCARADERO PESQUERO ARTESANAL DE SUPE **FECHA:**

CLIENTE: FONDO NACIONAL DE DESARROLLO PESQUERO - FONDEPES **SECTOR:**



CONTRATISTA: CONSORCIO MARITIMO DEL NORTE **AREA:**

Verificaciones Generales:

Limpieza Rugosidad Humedad

Ambiente / Eje	Alineamiento de muros		Verticalidad de muros		Uniformidad de muros		Tiraje Culinado de Muro		Encuentro cielo raso-muro tipo Medio Cafa		Verticalidad de derrama		Contrazocalo sanitario		Dimensiones de vanos		Cieloraso	
	C	FECHA	C	FECHA	C	FECHA	C	FECHA	C	FECHA	C	FECHA	C	FECHA	C	FECHA	C	FECHA

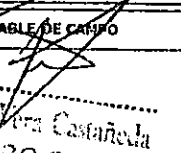
OBSERVACIONES:

<p>CONTROL DE CALIDAD</p> <p>Firma y sello:</p>  <p>BRAYAN GALINDO VEGA CONSORCIO MARITIMO DEL NORTE</p>	<p>RESPONSABLE DE CAMPO</p> <p>Firma y sello:</p>  <p>Ing. Luis M. Vera Castañeda INGENIERO CIVIL REG. CIP 140228</p>	<p>RESIDENTE DE OBRA</p> <p>Firma y sello:</p> 	<p>SUPERVISIÓN</p> <p>Firma y sello:</p>
--	--	---	---

000154

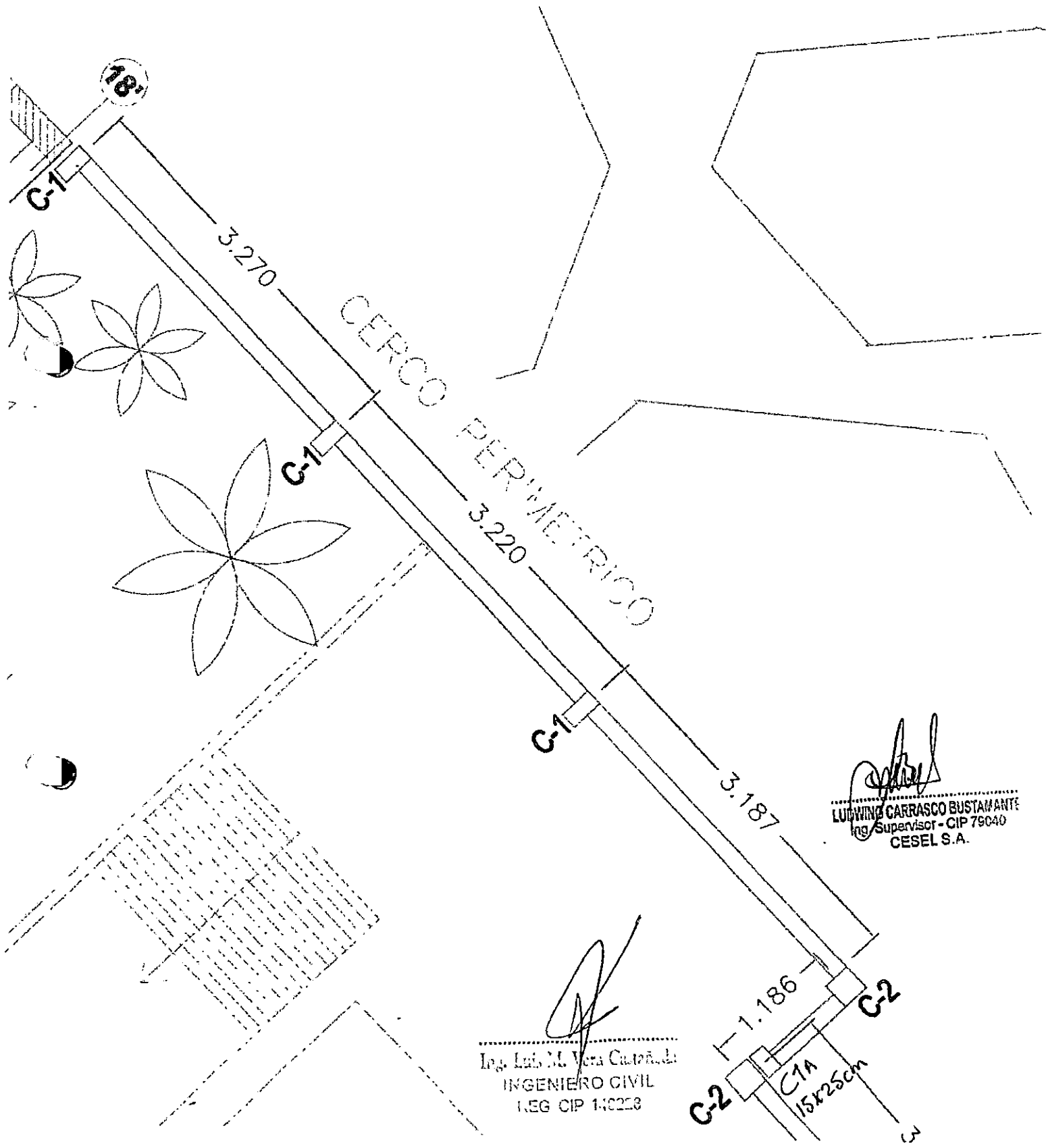

[Signature]
 LUDWIG CARRASCO BUSTAMANTE
 Ing. Supervisor - CIP 79040
 CESEL S.A.

[Signature]
 Ing. Luis M. Vera Castañeda
 INGENIERO CIVIL
 I. LEG. CIP 140223

[Signature]
 RESIDENTE EJECUTIVA
 RES. CIP N° 96618

804
000100

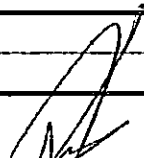
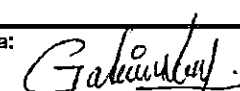
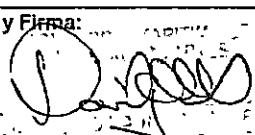
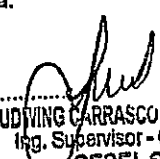
		REGISTRO DE CONTROL DE ALBAÑILERIA		CC275-RCAI -CMN	
CLIENTE: FONDO NACIONAL DE DESARROLLO PESQUERO - FONDEPES		REGISTRADO:			
CONTRATISTA: CONSORCIO MARITIMO DEL NORTE					
OBRA: MEJORAMIENTO Y RECUPERACIÓN DE LOS SERVICIOS DEL DESEMBARCADERO PESQUERO ARTESANAL DE SUPE		FECHA: 06/02/17			
Elemento :		Código de Tabique:			
Area Asentada (m2):		Fecha del Asentado: 07/02/17			
Etapa: Asentado de ladrillo					
Documentos de Referencia		Revisión		Observaciones	
Muro de Cerco Párrafo de Grapas (BIO 0000 4)					
Lista de Verificación Previa al Asentado (Ver Plano de Detalle)		FECHA		CONTRATISTA	
Sobrecimiento de Muro Terminado		06/02/17			
Trazo definido		06/02/17			
Espesor de Juntas definido		06/02/17			
Alineamiento		06/02/17			
Refuerzos		06/02/17			
Autorización para el asentado		06/02/17			
Ladrillo Humedecido		06/02/17			
Inicio de Asentado		07/02/17			
SUPERVISOR CALIDAD:				Fecha :	
Lista de Verificación Posterior al Asentado		FECHA		CONTRATISTA	
Variación : <input type="checkbox"/> Vertical <input type="checkbox"/> Nivel <input type="checkbox"/> Juntas asentado					
Verificación de Verticalidad					
Verificación de refuerzo					
Elementos Embebidos: Anclajes					
<input type="checkbox"/> Acero <input type="checkbox"/> Mecanica <input type="checkbox"/> Sanitario <input type="checkbox"/> Electricos					
Huecos de limpieza clausurados					
Corte de Mortero de Juntas al ras					
Comentarios:					
Responsable Campo		Sello y Firma:		Sello y Firma:	
 Ing. Luis M. Vera Castañeda INGENIERO CIVIL REG. CIP 140229		Control de Calidad		 CRISTIAN GALINDO YEGA CONTROL DE CALIDAD CONSORCIO MARITIMO DEL NORTE	
Residente de Obra		Sello y Firma:		Sello y Firma:	
 LUDWING CARRASCO BUSTAMANTE Ing. Supervisor - CIP 79040 CESEI S.A.		Supervisor de Obra		 LUDWING CARRASCO BUSTAMANTE Ing. Supervisor - CIP 79040 CESEI S.A.	



PROYECTO: **MEJORAMIENTO Y RECUPERACIÓN DE LOS SERVICIOS DEL DESEMBARCADERO PESQUERO ARTESANAL DE SUPE**

CC275-IVC/ -CMN

Elemento:

VACIADO DE CONCRETO EN COLUMNETAS

CONTRATISTA: CONSORCIO MARITIMO DEL NORTE		CLIENTE: FONDO NACIONAL DE DESARROLLO PESQUERO - FORDEPES	
FECHA DE VACIADO:		VOLUMEN A VACIAR: m3	
TIPO DE ESTRUCTURA:		REGISTRA PROJETAS: SI <input checked="" type="checkbox"/> NO <input type="checkbox"/> grupo:	
DOCUMENTOS DE REFERENCIA:		REV. N°	
METODO DE VACIADO: SIN BOMBA		OBSERVACIONES:	
Pc DISEÑO / CEMENTO tipo: kg/cm2		SLUMP: 4" - 6" pulgadas	
TAM. MAX. AGREGADO: pulgadas		TEMPERATURA: °C	
TIPO DE ACABADO:		METODO DE CURADO: AGUA	
CHECLIST PREVIO AL VACIADO		CONTRATISTA	
		SUPERVISION	
		CHECK	FECHA
		INICIALES / CHECK	FECHA
Materiales Aprobados (diseños, embelidos, demoldantes, curadores, etc.)		/	
Cambios Aprobados (cambios o modificaciones en elementos a vaciar)		/	
Inspección Topográfica (alineamiento, nivelación, dimensiones, etc.)		/	
Encofrado		/	
Armadura de refuerzo		/	
Limpieza dentro de encofrado		/	
Elementos Embelidos Civiles (anclajes, marcos, etc.)		/	
Elementos Embel. Mecánicos (pernos de anclajes, tuberías, etc.)		/	
Elementos Embelidos Eléctricos (conduit, red de tierra, etc.)		/	
Elementos Embel. Sistem. Esp. (conduit, red de tierra, etc.)		/	
Inspección Topográfica de elementos embelidos (alineamiento, nivelación, dimensiones, etc.)		/	
Equipos menores en buen estado (trazas vibratorias, vibradoras de aguja, etc.)		/	
Stock de Materiales (curador, lintina poliestireno, vigas tipo puente, mantas de yute, reglas, etc.)		/	
Otro (especificar):			
PRE-VACIADO VERIFICADO POR		SUPERVISION	
NOMBRE:			
FIRMA:			
Ing. Residente - Contratista			
Vº Bº / Aprobación:			
CHECLIST POSTERIOR AL VACIADO		CHECK	
		FECHA	
		CHECK	
		FECHA	
Inspección Topográfica de elementos vaciados (alineamiento, nivelación, dimensiones, etc.)			
Inspección Topográfica de elementos embelidos (alineamiento, nivelación, dimensiones, etc.)			
Buen acabado en el concreto fresco después de colocado.			
Curado adecuado.			
CONFORME CON REPARACION:		Especificar proceso de reparación:	
SI <input type="checkbox"/> NO <input type="checkbox"/> NO APLICA <input type="checkbox"/>			
COMENTARIOS:			
Responsable de Campo	Seño y Firma: Ing. Luis M. Carrasco de INGENIERO CIVIL R.C.C. CIP 140328	Control de Calidad	Seño y Firma: EDWIN GALINDO YEGA CONTROL DE CALIDAD CONSORCIO MARITIMO DEL NORTE
Residente De Obra	Seño y Firma: EDWIN GALINDO YEGA INGENIERO CIVIL R.C.C. CIP 140328	Supervisor de Obra	Seño y Firma: LUDWIG CARRASCO BUSTAMANTE Ing. Supervisor - CIP 7000



PROYECTO: MEJORAMIENTO Y RECUPERACIÓN DE LOS SERVICIOS DEL DESEMBARCADERO PESQUERO ARTESANAL DE SUPE

CC275-IECTCI -GMN
REGISTRO: 000250

INSPECCION DE ENCOFRADO

Contratista:	CONSORCIO MARITIMO DEL NORTE	Fecha:	
Cliente:	FONDO NACIONAL DE DESARROLLO PESQUERO - FONDEPES	Documentos de referencia:	
Ubicación:			
Tipo de estructura:			

ESQUEMA DEL ENCOFRADO:

Graficar el elemento, identificar ubicación por ejes, puntualizar detalles del encofrado

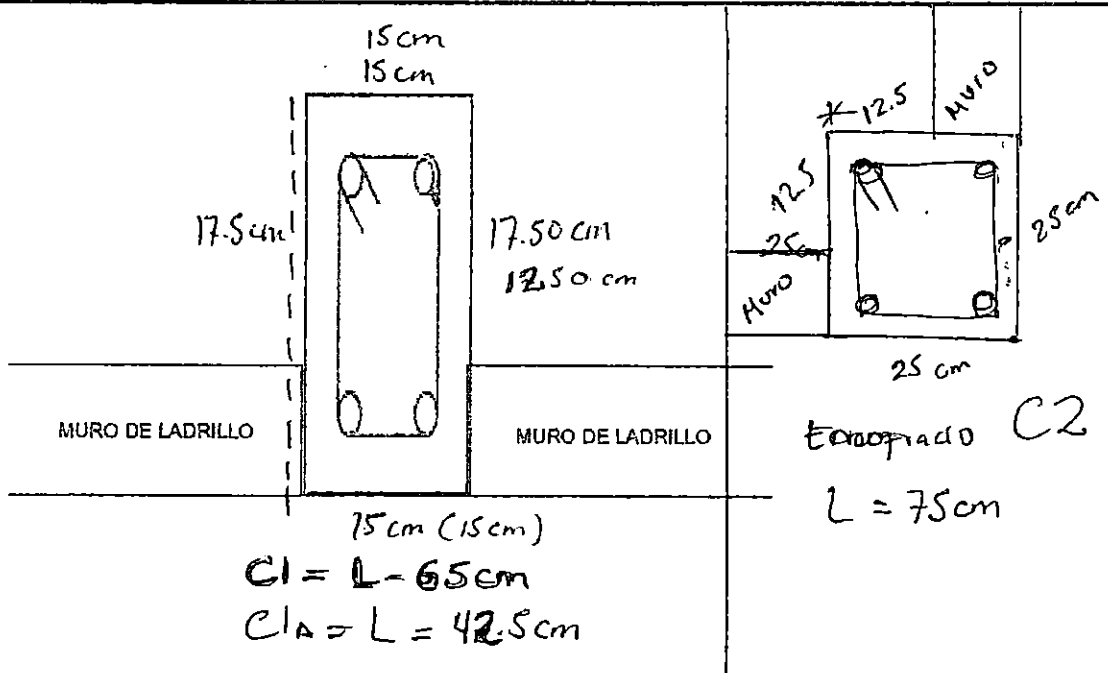

DATOS DIMENSIONALES (mm):

FUNTOS PLOMADA																			
ARRIBA																			
ABAJO																			
DESVIACION																			

CHECUIST DEL ENCOFRADO:

	CONFORME	NO CONFORME	NO APLICA	REPARADO/CO REGIDO	COMENTARIOS
Materia del encofrado	/				
Condición del encofrado	/				
Plaza de firmas del encofrado	/				
Forma y dimensiones del encofrado	/				
Aplicación de desmoldante	/				
Aseguramiento de soleras	/				
Apuntalamiento y fijación	/				
Hermeticidad del encofrado	/				
Fecha de desencofrado	/				

COMENTARIOS / OBSERVACIONES GENERALES:

Responsable de Campo:	Sello y Firma: Ing. Luis V. V. Galindo Vega INGENIERO CIVIL REG. CIP 140229	Control de Calidad:	Sello y Firma: BRAYAN GALINDO VEGA CONTROL DE CALIDAD CONSORCIO MARITIMO DEL NORTE
Residente de Obra:	Sello y Firma: LUDWING CARRASCO BUSTAMANTE Ing. Supervisor - CIP 79040 CESELSA	Supervisor de Obra:	Sello y Firma: LUDWING CARRASCO BUSTAMANTE Ing. Supervisor - CIP 79040 CESELSA



INSPECCION DE ACERO DE REFUERZO

CC275-IAR/ -CMN

000249

CLIENTE:	FONDO NACIONAL DE DESARROLLO PESQUERO - FONDEPES	REGISTRO:
CONTRATISTA:	CONSORCIO MARÍTIMO DEL NORTE	
OBRA:	MEJORAMIENTO Y RECUPERACIÓN DE LOS SERVICIOS DEL DESEMBARCADERO PESQUERO ARTESANAL DE SUPE	FECHA:

UBICACION:	DOCUMENTOS DE REFERENCIA:
SECTOR:	
T. ESTRUCTURA:	

ESQUEMA DE LA ARMADURA: Graficar el elemento, identificar ubicación por ejes, puntualizar detalles del acero.

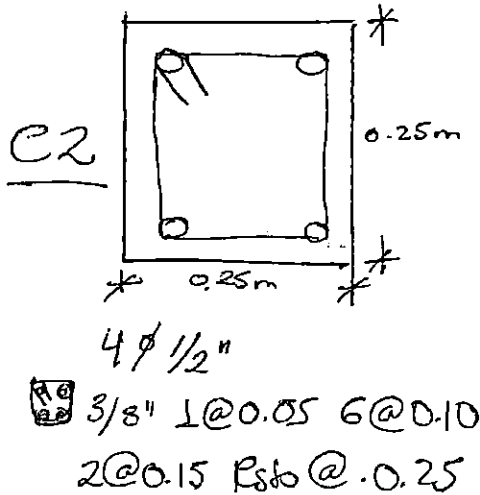

CHECKLIST DEL ACERO DE REFUERZO

	CONFORME	NO CONFORME	NO APLICA	REPARADO/CORREGIDO	COMENTARIOS
Limpieza (corrosión, concreto, grasa)	/				
Calidad del acero (Norma ASTM, grado, marca)	/				
Díámetro de varilla	/				
Longitud de traslape	/				
Longitud de gancho	/				
Espaciamiento entre barras	/				
Espaciamiento de estribos	/				
Alambre de amarre	/				
Soportes para recubrimiento contra base	/				
Soportes para recubrimiento lateral	/				
Verticalidad (plomada)	/				
Horizontalidad (nivel)	/				

COMENTARIOS / OBSERVACIONES GENERALES:

Responsable de Campo:	Sello y Firma: Ing. Livi M. Vega, Creada INGENIERO CIVIL REG CIP 140228	Control de Calidad:	Sello y Firma: GRAYAN BALINDO VEGA CONTROL DE CALIDAD CONSORCIO MARÍTIMO DEL NORTE
Residente de Obra:	Sello y Firma: LUDWING CARRASCO BUSTAMANTE Ing. Supervisor - CIP 79010 CESEL S A	Supervisor de Obra:	Sello y Firma: LUDWING CARRASCO BUSTAMANTE Ing. Supervisor - CIP 79010 CESEL S A

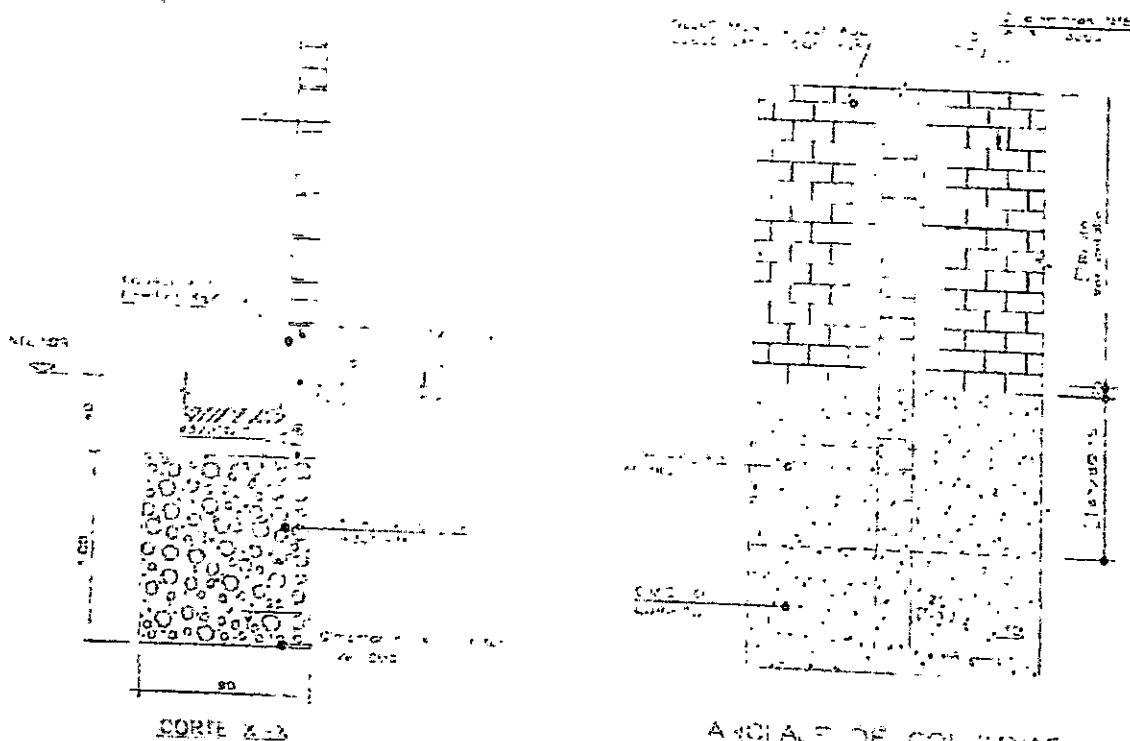
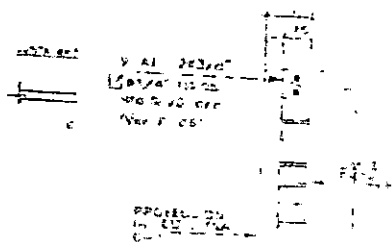
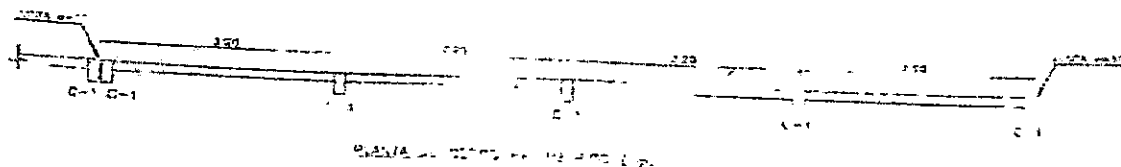

1/2" x 1/2" x 1/2" (19.05, 19.05, 19.05)
 20.15, 20.15, 20.15

C-1
 1/2" x 1/2"

LUDWIG GARRASCO BUSTAMANTE
 Ing. Supervisor - CIP 79040
 CESEL S.A.

Figura 3: Cerco Perimétrico propuesto

[Handwritten signature]

[Handwritten signature]
 BRAYAN GALINDO VESA
 CONTROL DE CALIDAD
 COMISIÓN ELECTORAL DEL NORTE



PROYECTO: **MEJORAMIENTO Y RECUPERACIÓN DE LOS SERVICIOS DEL DESEMBARCADERO PESQUERO ARTESANAL DE SUPE**

REGISTRO: **CC275-IEGCI -CMN**
 010-47

INSPECCION DE ENCOFRADO

Contratista:	CONSORCIO MARITIMO DEL NORTE	Fecha:	
Cliente:	FONDO NACIONAL DE DESARROLLO PESQUERO - FONDEPES	Documentos de referencia:	
Ubicación:			
Tipo de estructura:			

ESQUEMA DEL ENCOFRADO:

Graficar el elemento, identificar ubicación por ejes, puntualizar detalles del encofrado

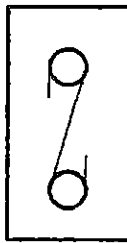

Estructura: 12.5cm x 13 cm
 Arquitectura: 15cm x 15 cm

DATOS DIMENSIONALES (mm):

PUNTOS PLOMADA																				
ARRIBA																				
ABAJO																				
DESVIACION																				

CHECKLIST DEL ENCOFRADO:

	CONFORME	NO CONFORME	NO APLICA	REPARADO/CO RREGIDO	COMENTARIOS
Material del encofrado	/				
Condición del encofrado	/				
Pieza de formas del encofrado	/				
Forma y dimensiones del encofrado	/				
Aplicación de desmoldante	/				
Aseguramiento de soleras	/				
Apuntalamiento y fijación	/				
Hermeticidad del encofrado	/				
Fecha de desencofrado					

COMENTARIOS / OBSERVACIONES GENERALES:

Responsable de Campo:	Sello y Firma: Ing. Luis M. Vera Casañeda INGENIEPO CIVIL REG. CIP 140228	Control de Calidad:	Sello y Firma: BRAYAN GALINDO VEGA CONTROL DE CALIDAD CONSORCIO MARITIMO DEL NORTE
Residente de Obra:	Sello y Firma: 	Supervisor de Obra:	Sello y Firma: J. J. CARRASCO BUSTAMANTE Ing. Supervisor - CIP 79040 CESELS



PROYECTO:
**MEJORAMIENTO Y RECUPERACIÓN DE LOS SERVICIOS DEL
 DESEMBARCADERO PESQUERO ARTESANAL DE SUPE**

000246

CC275-4VCI -CMN

Elemento:

VACIADO DE CONCRETO EN VIGA

CONTRATISTA: CONSORCIO MARITIMO DEL NORTE		CLIENTE: FONDO NACIONAL DE DESARROLLO PESQUERO - FONDEPES	
FECHA DE VACIADO:		VOLUMEN A VACIAR: m3	
TIPO DE ESTRUCTURA:		REGISTRA PROBETAS: SI NO GRUPO:	
DOCUMENTOS DE REFERENCIA:		REV. N°	
METODO DE VACIADO: SIN BOMBA		SLUMP: 4" - 6" pulgadas	
f'c DISEÑO / CEMENTO tipo: kg/cm2		TEMPERATURA: °C	
TAM. MAX. AGREGADO: pulgadas		METODO DE CURADO: AGUA	
TIPO DE ACABADO:		CONTRATISTA	
CHECKLIST PREVIO AL VACIADO		SUPERVISION	
	CHECK	FECHA	INICIALES / CHECK
Materiales Aprobados (diseños, embobklos, demolidantes, curadores, etc)	/		
Cambios Aprobados (cambios o modificaciones en elementos a vaciar)	/		
Inspección Topográfica (alineamiento, nivelación, dimensiones, etc.)	/		
Encofrado	/		
Armadura de refuerzo	/		
Limpieza dentro de encofrado	/		
Elementos Embebidos Civiles (anclajes, marcos, etc.)	/		
Elementos Embeb. Mecánicos (pernos de anclajes, tuberías, etc.)	/		
Elementos Embebidos Eléctricos (conduit, red de tierra, etc.)	/		
Elementos Embeb. Sistem. Esp. (conduit, red de tierra, etc.)	/		
Inspección Topográfica de elementos embebidos (alineamiento, nivelación, dimensiones, etc.)	/		
Equipos menores en buen estado (reglas vibratorias, vibradoras de aguja, etc)	/		
Stock de Materiales (curador, lamina polietileno, vigas tipo puente, mantas de yute, reglas, etc)	/		
Otro (especificar):			
PRE-VACIADO VERIFICADO POR	NOMBRE:	SUPERVISION	
	FIRMA:		
Ing. Residente - Contratista			
Vº Bº / Aprobación _____			
	CHECK	FECHA	CHECK
CHECKLIST POSTERIOR AL VACIADO			FECHA
Inspección Topográfica de elementos vaciados (alineamiento, nivelación, dimensiones, etc.)			
Inspección Topográfica de elementos embebidos (alineamiento, nivelación, dimensiones, etc.)			
Buen acabado en el concreto fresco después de colocado.			
Curado adecuado.			
CONFORME CON REPARACIÓN: SI <input type="checkbox"/> NO <input type="checkbox"/> NO APLICA <input type="checkbox"/>		Especificar proceso de reparación:	
COMENTARIOS:			
Responsable de Campo	Seño y Firma: Ing. Luis M. V. Castañeda INGENIERO CIVIL REG. CIP 140228	Control de Calidad	Seño y Firma: BRAYAN GALINDO VEGA CONTROL DE CALIDAD CONSORCIO MARITIMO DEL NORTE
Residente De Obra	Seño y Firma:	Supervisor de Obra	Seño y Firma: LUDWIG CARRASCO BUSTAMANT Ing. Supervisor - CIP 79040 CESEL S.A



CONTROL DE CALIDAD

INSPECCION DE TARRAJEOS Y DERRAMES

NOMBRE DEL PROYECTO: MEJORAMIENTO Y RECUPERACION DE LOS SERVICIOS DEL DESMARCADERO PESQUERO ARTESANAL DE SUPE FECHA:

CLIENTE: FONDO NACIONAL DE DESARROLLO PESQUERO - FONDEFES SECTOR:

CONTRATISTA: CONSORCIO MARITIMO DEL NORTE AREA:

Verificaciones Generales:

Limpieza Regosidad Humedad

Ambiente / Eje	Alineamiento de muros		Verticalidad de muros		Uniformidad de muros		Tarares Cuestionado de Muro		Encuentro entre muros tipo Media Caña		Verticalidad de derrame		Contrazocla sanitaria		Disminuciones de vano		Colorado		
	C	FECHA	C	FECHA	C	FECHA	C	FECHA	C	FECHA	C	FECHA	C	FECHA	C	FECHA	C	FECHA	
Muro (Interior)	/		/		/		/	28/02/19											
Muro (Exterior)	/		/		/		/												
Columna	/		/		/		/	28/02/19											
Vejeta	/		/		/		/	28/02/19											
electrom.	/																		

OBSERVACIONES:

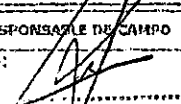
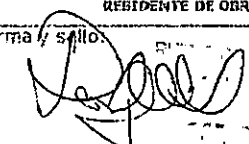
<p>CONTROL DE CALIDAD</p> <p>Firma y sello:</p>  <p>BRUNO GALINDO YRGA CONTROL DE CALIDAD CONSORCIO MARITIMO DEL NORTE</p>	<p>RESPONSABLE DE CAMPO</p> <p>Firma y sello:</p>  <p>Ing. L. Vera Castañeda INGENIERO CIVIL REG. CIP 140228</p>	<p>RESIDENTE DE OBRA</p> <p>Firma y sello:</p> 	<p>SUPERVISIÓN</p> <p>Firma y sello:</p>
---	---	--	--

000245

BLOQUE 01.

000144

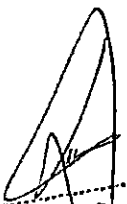

Ing. Luis M. Vera Castañeda
INGENIERO CIVIL
REG. CIP 140228

LUDWIG CARRASCO BUSTAMANTE
Ing. Supervisor - CIP 79040
CESEL S.A.

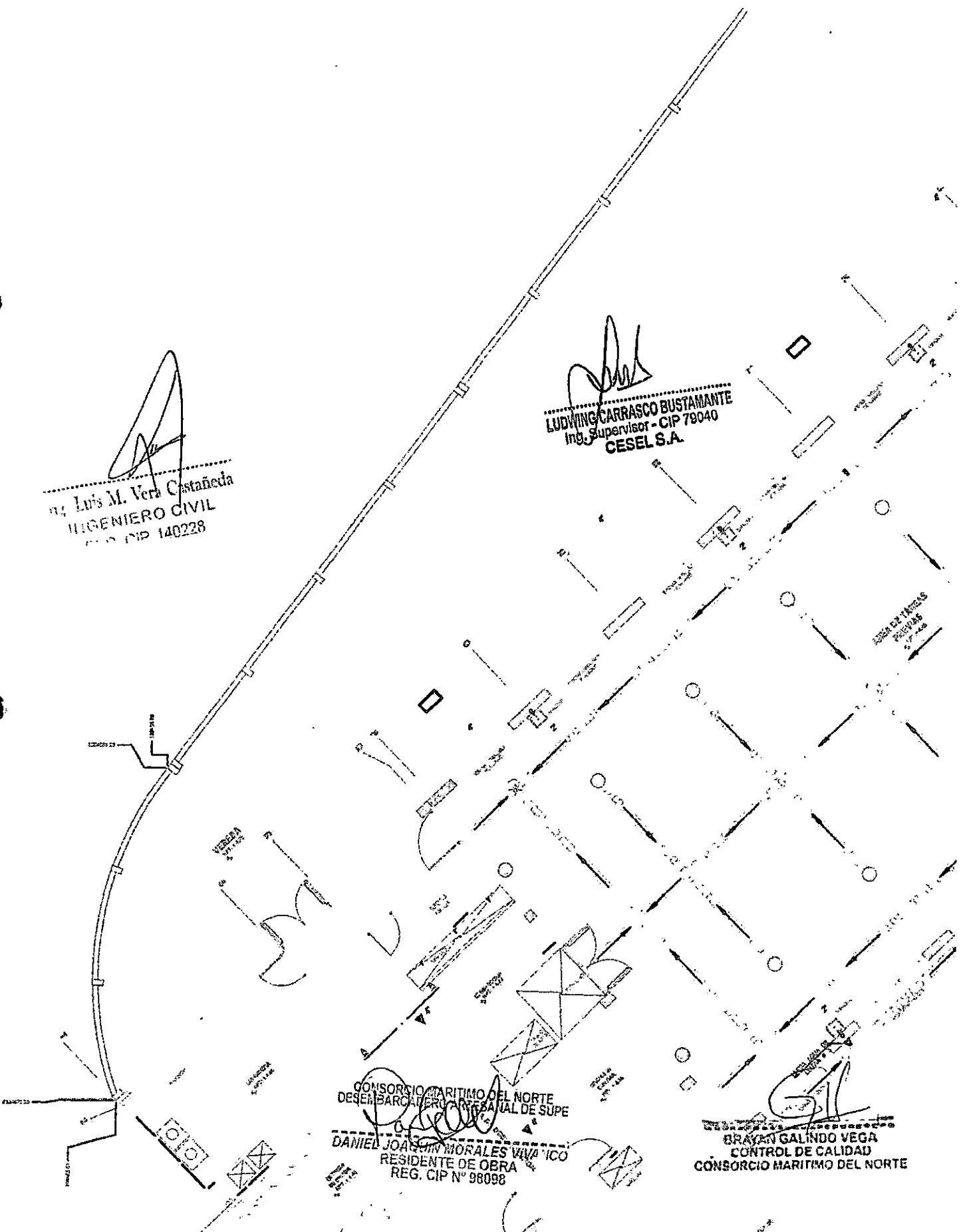

CONSORCIO MARITIMO DEL NORTE
DESEMBARCADERO CANAL DE SUPE

DANIEL JOAQUÍN MORALES VIVA
RESIDENTE DE OBRA
REG. CIP N° 98098

BRYAN GALINDO VEGA
CONTROL DE CALIDAD
CONSORCIO MARITIMO DEL NORTE

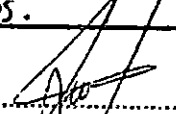

000143

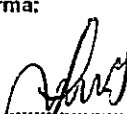
		REGISTRO DE CONTROL ASENTADO DE LADRILLO TIPO IV		CC275-RCAI -CMN	
CLIENTE:	FONDO NACIONAL DE DESARROLLO PESQUERO - FONDEPES			REGISTRO:	
CONTRATISTA:	CONSORCIO MARITIMO DEL NORTE			FECHA:	
OBRA:	MEJORAMIENTO Y RECUPERACIÓN DE LOS SERVICIOS DEL DESEMBARCADERO PESQUERO ARTESANAL DE SUPE				
Elemento: <i>Muro de Cerco</i>		Codigo de Tabique:			
Area Asentada (m2):		Fecha del Asentado: <i>31-01-19</i>			
Etapa:					
Documentos de Referencia		Revisión	Observaciones		
<i>EET-J</i>					
Lista de Verificación Previa al Asentado (Ver Plano de Detalle)		FECHA	CONTRATISTA	SUPERVISION	CONFORMIDAD
Sobrecimiento de Muro Terminado		<i>31-01-19</i>	<input checked="" type="checkbox"/>		
Trazo definido		<i>31-01-19</i>	<input checked="" type="checkbox"/>		
Espesor de juntas definidas		<i>31-01-19</i>	<input checked="" type="checkbox"/>		
Alineamiento		<i>31-01-19</i>	<input checked="" type="checkbox"/>		
Refuerzos		<i>31-01-19</i>	<input checked="" type="checkbox"/>		
Autorizado para el Asentado		<i>31-01-19</i>	<input checked="" type="checkbox"/>		
Ladrillo humedecido		<i>30-01-19</i>	<input checked="" type="checkbox"/>		
Inicio de Asentado		<i>31-01-19</i>	<input checked="" type="checkbox"/>		
SUPERVISOR CALIDAD:		Fecha:			
Lista de Verificación Posterior al Asentado		FECHA	CONTRATISTA	SUPERVISION	CONFORMIDAD
Variación: <input type="checkbox"/> Vertical <input type="checkbox"/> Nivel <input type="checkbox"/> Juntas asentado					
Verificación de Verticalidad					
Verificación de Refuerzo					
Elementos Embebidos: Anclajes					
<input type="checkbox"/> Acero <input type="checkbox"/> Mecanico <input type="checkbox"/> Sanitario <input type="checkbox"/> Electricos					
Huecos de limpieza clausurados					
Corte de Mortero de Juntas al ras					
Comentarios: <i>Eliminar los ladrillos rajados. El contratista debe identificar los ladrillos rajados y cambiarlos.</i>					
Responsable Campo	Sello y Firma:  Ing. Luis M. Vera Castañeda INGENIERO CIVIL REG. CIP 140228		Control de Calidad	Sello y Firma:  RAFAEL GALINDO VEGA CONTROL DE CALIDAD CONSORCIO MARITIMO DEL NORTE	
Residente de Obra	Sello y Firma:  DANIEL JOAQUÍN MORALES VIVERO RESIDENTE DE OBRA REG. CIP N° 98098		Supervisor de Obra	Sello y Firma:  LUDWIG CARRASCO BUSTAMANTE Ing. Supervisor - CIP 79040 CESEL S.A.	

000142



PROYECTO:

**MEJORAMIENTO Y RECUPERACIÓN DE LOS SERVICIOS DEL
DESEMBARCADERO PESQUERO ARTESANAL DE SUPE**

CC275-IVCI -CMN

Elemento:

VACIADO DE CONCRETO EN COLUMNETAS

CONTRATISTA: CONSORCIO MARITIMO DEL NORTE		CLIENTE: FONDO NACIONAL DE DESARROLLO PESQUERO - FONDEPES	
FECHA DE VACIADO:	12/02/19	VOLUMEN A VACIAR:	m3
TIPO DE ESTRUCTURA:	columneta	REGISTRA PROBETAS:	SI <input checked="" type="checkbox"/> NO <input type="checkbox"/>
DOCUMENTOS DE REFERENCIA:	REV. N°	OBSERVACIONES:	GRUPO:
E/E 7-4.			
METODO DE VACIADO:	SIN BOMBA		
F_c DISEÑO / CEMENTO Tipo:	210	kg/cm ²	SLUMP: 4" - 6"
TAM. MAX. AGREGADO:	1/2"	pulgadas	TEMPERATURA: °C
TIPO DE ACABADO:	METODO DE CURADO: AGUA		
CHECKLIST PREVIO AL VACIADO		CONTRATISTA	
	CHECK	FECHA	SUPERVISION
			INICIALES / CHECK
			FECHA
Materiales Aprobados (diseños, embebidos, demolidores, curadores, etc.)	/		
Cambios Aprobados (cambios o modificaciones en elementos a vaciar)	/		
Inspección Topográfica (alineamiento, nivelación, dimensiones, etc.)	/		
Encofrado	/		
Armadura de refuerzo	/		
Limpieza dentro de encofrado	/		
Elementos Embebidos Civiles (anclajes, marcos, etc.)	/		
Elementos Embeb. Mecánicos (pernos de anclajes, tuberías, etc.)	/		
Elementos Embebidos Eléctricos (conduit, red de tierra, etc.)	/		
Elementos Embeb. Sistem. Esp. (conduit, red de tierra, etc.)	/		
Inspección Topográfica de elementos embebidos (alineamiento, nivelación, dimensiones, etc.)	/		
Equipos menores en buen estado (reglas vibratorias, vibradoras de aguja, etc.)	/		
Stock de Materiales (curador, lamina polietileno, vigas tipo puente, montas de yute, reglas, etc.)	/		
Otro (especificar):			
PRE-VACIADO VERIFICADO POR	NOMBRE:	SUPERVISION	
	FIRMA:		
Ing. Residente - Contratista			
Vº Bº / Aprobación			
CHECKLIST POSTERIOR AL VACIADO	CHECK	FECHA	CHECK
			FECHA
Inspección Topográfica de elementos vaciados (alineamiento, nivelación, dimensiones, etc.)			
Inspección Topográfica de elementos embebidos (alineamiento, nivelación, dimensiones, etc.)			
Buen acabado en el concreto fresco después de colocado.			
Curado adecuado.			
CONFORME CON REPARACIÓN:	<input type="checkbox"/> SI <input type="checkbox"/> NO <input type="checkbox"/> NO APLICA <input type="checkbox"/>		
	Especificar proceso de reparación:		
COMENTARIOS:			
Responsable de Campo	Sello y Firma: Ing. Luis M. Vera Castañeda INGENIERO/CIVIL REG CIP 140228	Control de Calidad	Sello y Firma: BRYAN GALINDO VEGA CONTROL DE CALIDAD CONSORCIO MARITIMO DEL NORTE
Residente De Obra	Sello y Firma: DANIEL JOSÉ RESIDENTE DE OBRA REG CIP 140008	Supervisor de Obra	Sello y Firma: LUDWIG CARRASCO BUSTAMANTE Ing. Supervisor - CIP 78040 CESEL S.A.



INSPECCION DE ACERO DE REFUERZO

CC275-IAR/ -CMN

000-4

CLIENTE:	FONDO NACIONAL DE DESARROLLO PESQUERO - FONDEPES	REGISTRO:
CONTRATISTA:	CONSORCIO MARÍTIMO DEL NORTE	
OBRA:	MEJORAMIENTO Y RECUPERACIÓN DE LOS SERVICIOS DEL DESEMBARCADERO PESQUERO ARTESANAL DE SUPE	FECHA:

UBICACION:	EJE T-H.	DOCUMENTOS DE REFERENCIA:
SECTOR:	MUD de Cerco	
T. ESTRUCTURA:	Columna de Cerco	

ESQUEMA DE LA ARMADURA: Graficar el elemento, identificar ubicación por ejes, puntualizar detalles del acero.



Figura 3: Cerco Perimétrico propuesto

CHECKLIST DEL ACERO DE REFUERZO

	CONFORME	NO CONFORME	NO APLICA	REPARADO/CORREGIDO	COMENTARIOS
Limpieza (corrosión, concreto, grasa)	///				
Calidad del acero (Norma ASTM, grado, marca)	///				
Diámetro de varilla	///				
Longitud de traslape	///				
Longitud de gancho	///				
Espaciamiento entre barras	///				
Espaciamiento de estribos	///				
Diámetro de amarre	///				
Soportes para recubrimiento contra base	///				
Soportes para recubrimiento lateral	///				
Verticalidad (plomada)	///				
Horizontalidad (nivel)	///				

COMENTARIOS / OBSERVACIONES GENERALES:

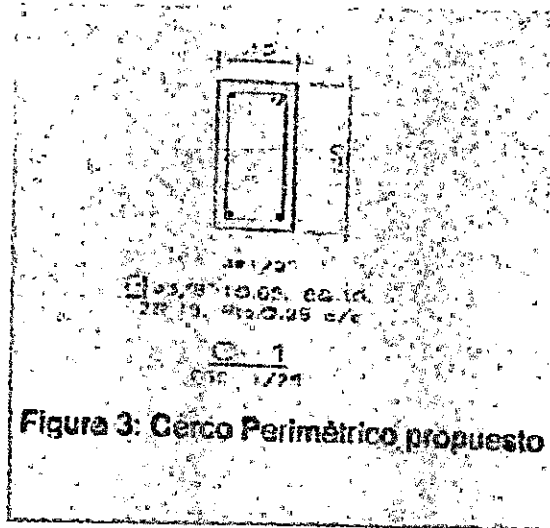
Responsable de Campo:	Sello y Firma: Ing. Luis M. Vera Castañeda INGENIERO CIVIL REG CIP 140228	Control de Calidad:	Sello y Firma: GALINDO VEGA CONTROL DE CALIDAD CONSORCIO MARITIMO DEL NORTE
Residente de Obra:	Sello y Firma: REG. CIP N. 50003	Supervisor de Obra:	Sello y Firma: LUDWIG CARRASCO BUSTAMANTE Ing. Supervisor - CIP 79040 CESEL S.A.



PROYECTO: MEJORAMIENTO Y RECUPERACIÓN DE LOS SERVICIOS DEL DESEMBARCADERO PESQUERO ARTESANAL DE SUPE

GC275-HECTCI -CMN
REGISTRO: 000140

INSPECCION DE ENCOFRADO

Contratista:	CONSORCIO MARITIMO DEL NORTE	Fecha:	11/02/19
Cliente:	FONDO NACIONAL DE DESARROLLO PESQUERO - FONDEPES	Documentos de referencia:	
Ubicación:	Muro de CAYCO E/E = 7-H		
Tipo de estructura:	Columnetas		

ESQUEMA DEL ENCOFRADO:

Graficar el elemento, identificar ubicación por ejes, puntualizar detalles del encofrado

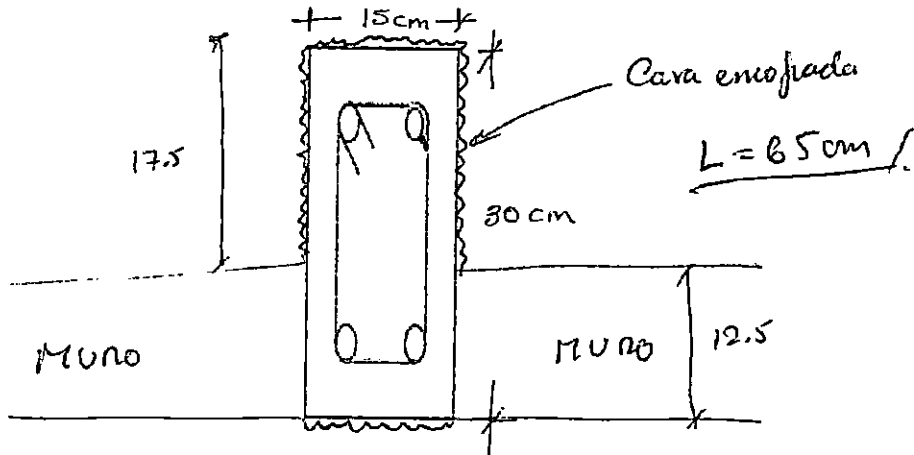

DATOS DIMENSIONALES (mm):

PUNTOS PLOMADA									
ARRIBA									
ABAJO									
DESVIACION									

CHECKLIST DEL ENCOFRADO:

	CONFORME	NO CONFORME	NO APLICA	REPARADO/CO RREGIDO	COMENTARIOS
Material del encofrado	/				
Condición del encofrado	/				
Limpeza de formas del encofrado	/				
Forma y dimensiones del encofrado	/				
Aplicación de desmoldante	/				
Aseguramiento de soleras	/				
Apuntalamiento y fijación	/				
Hermeticidad del encofrado	/				
Fecha de desencofrado	/				

COMENTARIOS / OBSERVACIONES GENERALES:

Responsable de Campo:	<p>Sello y Firma:</p> <p>Ing. Luis M. Vera Castañeda INGENIERO CIVIL REG. CIP 140295</p>	Control de Calidad:	<p>Sello y Firma:</p> <p>INGENIERO GALINDO VEGA CONTROL DE CALIDAD CONSORCIO MARITIMO DEL NORTE</p>
Residente de Obra:	<p>Sello y Firma:</p> <p>CONSORCIO MARITIMO DEL NORTE RESIDENTE DE OBRA REG. CIP 79040</p>	Supervisor de Obra:	<p>Sello y Firma:</p> <p>LUDWING CABRASCO BUSTAMANTE Ing. Supervisor - CIP 79040 CESEL S.A.</p>



PROYECTO: **MEJORAMIENTO Y RECUPERACIÓN DE LOS SERVICIOS DEL DESEMBARCADERO PESQUERO ARTESANAL DE SUPE**

CC275-IECTCI -CMN
REGISTRO:

000-39

INSPECCION DE ENCOFRADO

Contratista:	CONSORCIO MARITIMO DEL NORTE		Fecha:	
Ciente:	FONDO NACIONAL DE DESARROLLO PESQUERO - FONDEPES		Documentos de referencia:	
Ubicación:				
Tipo de estructura:				

ESQUEMA DEL ENCOFRADO:

Graficar el elemento, identificar ubicación por ejes, puntualizar detalles del encofrado

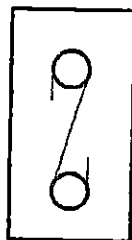

13 cm

12.5 cm

Estructura: 12.5cm x 13 cm

Arquitectura: 15cm x 15 cm

DATOS DIMENSIONALES (mm):

PUNTOS PLOMADA																				
ARRIBA																				
ABAJO																				
DESVIACION																				

CHECKLIST DEL ENCOFRADO:

	CONFORME	NO CONFORME	NO APLICA	REPARADO/CO RREGIDO	COMENTARIOS
Material del encofrado	///				
Condición del encofrado	///				
Empieza de formas del encofrado	///				
Forma y dimensiones del encofrado	///				
Aplicación de desmoldante	///				
Aseguramiento de soleras	///				
Apuntalamiento y fijación	///				
Hermeticidad del encofrado	///				
Fecha de desencofrado	///				

COMENTARIOS / OBSERVACIONES GENERALES:

Responsable de Campo:	Sello y Firma: Ing. Luis M. Vega Castañeda INGENIERO CIVIL REG. CIP 140228	Control de Calidad:	Sello y Firma: BRAYAN GALINDO VEGA CONTROL DE CALIDAD CONSORCIO MARITIMO DEL NORTE
Residente de Obra:	Sello y Firma: CONSORCIO MARITIMO DEL NORTE FONDO NACIONAL DE DESARROLLO PESQUERO DESEMBAICADERO PESQUERO ARTESANAL DE SUPE R.L. S. CMN 90096 REG. CIP N. 90096	Supervisor de Obra:	Sello y Firma: LUDWING CARRASCO BUSTAMANTE Ing. Supervisor - CIP 79040 CESEL S.A.



PROYECTO:
**MEJORAMIENTO Y RECUPERACIÓN DE LOS SERVICIOS DEL
 DESEMBARCADERO PESQUERO ARTESANAL DE SUPE**

000138

CC275-IVC/ -CMN

Elemento:

VACIADO DE CONCRETO EN VIGA

CONTRATISTA: CONSORCIO MARITIMO DEL NORTE		CLIENTE: FONDO NACIONAL DE DESARROLLO PESQUERO - FONDEPES	
FECHA DE VACIADO:		VOLUMEN A VACIAR:	
TIPO DE ESTRUCTURA:		REGISTRA PROBETAS: SI NO	
DOCUMENTOS DE REFERENCIA:		OBSERVACIONES:	
REV. N°		GRUPO:	
METODO DE VACIADO: SIN BOMBA		SLUMP: 4" - 6"	
f'c DISEÑO / CEMENTO tipo:		TEMPERATURA: °C	
TAM. MAX. AGREGADO: pulgadas		METODO DE CURADO: AGUA	
TIPO DE ACABADO:		CONTRATISTA	
CHECKLIST PREVIO AL VACIADO		SUPERVISION	
		CHECK	FECHA
		INICIALES / CHECK	FECHA
Materiales Aprobados (diseños, embebidos, demoldantes, curadores, etc.)			
Cambios Aprobados (cambios o modificaciones en elementos a vaciar)			
Inspección Topográfica (alineamiento, nivelación, dimensiones, etc.)			
Encofrado			
Armadura de refuerzo			
Limpieza dentro de encofrado			
Elementos Embebidos Civiles (anclajes, marcos, etc.)			
Elementos Embeb. Mecánicos (pernos de anclajes, tuberías, etc.)			
Elementos Embebidos Eléctricos (conduit, red de tierra, etc.)			
Elementos Embeb. Sistem. Esp. (conduit, red de tierra, etc.)			
Inspección Topográfica de elementos embebidos (alineamiento, nivelación, dimensiones, etc.)			
Equipos menores en buen estado (reglas vibratorias, vibradoras de aguja, etc.)			
Stock de Materiales (curador, lamina polietileno, vigas tipo puente, montas de yute, reglas, etc.)			
Otro (especificar):			
PRE-VACIADO VERIFICADO POR		SUPERVISION	
NOMBRE:			
FIRMA:			
Ing. Residente - Contratista			
Vº Bº / Aprobación			
CHECKLIST POSTERIOR AL VACIADO		CHECK	FECHA
Inspección Topográfica de elementos vaciados (alineamiento, nivelación, dimensiones, etc.)			
Inspección Topográfica de elementos embebidos (alineamiento, nivelación, dimensiones, etc.)			
Buen acabado en el concreto fresco después de colocado.			
Curado adecuado.			
CONFORME CON REPARACIÓN: SI <input type="checkbox"/> NO <input type="checkbox"/> NO APLICA <input type="checkbox"/>		Especificar proceso de reparación:	
COMENTARIOS:			
Responsable de Campo	Sello y Firma: Ing. Luis M. Vera Castañeda INGENIERO CIVIL REG. CIP 140228	Control de Calidad	Sello y Firma: BRAYA GALINDO VEGA CONTROL DE CALIDAD CONSORCIO MARITIMO DEL NORTE
Residente De Obra	Sello y Firma: LUDWING CARRASCO BUSTAMANTE Ing. Supervisor - CIP 79040 CESEL S.A.	Supervisor de Obra	

 CONSORCIO MARITIMO DEL NORTE	CONSORCIO MARÍTIMO DEL NORTE		
	MEJORAMIENTO Y RECUPERACION DE LOS SERVICIOS DEL DESEMBARCADERO PESQUERO ARTESANAL DE SUPE, DISTRITO DE SUPE PUERTÓ, PROVINCIA DE BARRANCA, REGIÓN LIMA		
Tipo de Documento	N°	Mes	Fecha
Valorización	18	Febrero	28/02/2019

2.2 ESTATUS DE PERMISOS Y LICENCIAS



MUNICIPALIDAD PROVINCIAL
DE BARRANCA

"Año de la Consolidación del Mar de Grau"

Que, la Comisión de Servicios Públicos presenta su dictamen señalando la conformidad del convenio, debiéndose agregar detalles expuestos al pleno del Concejo y que formaran parte del Convenio a aprobarse.

Que, en cumplimiento de lo dispuesto el Artículo 17° y 41° de la Ley N° 27972 - Ley Orgánica de Municipalidades y el Artículo 194° de la Constitución Política del Perú, el Pleno del Concejo Provincial de Barranca con el voto UNÁNIME de los Señores Regidores presentes y con dispensa del trámite de lectura y aprobación de Acta, se:

ACUERDA:

- ARTICULO 1.- APROBAR, la SUSCRIPCION DEL "CONVENIO INTERINSTITUCIONAL ENTRE LA MUNICIPALIDAD PROVINCIAL DE BARRANCA Y LA EMPRESA AGRICULTURA Y SERVICIOS S.R.L- AGSYS SRL EN RELACION A LA GESTION DEL MANEJO DE RESIDUOS SOLIDOS EN LA DISPOSICION FINAL"
- ARTICULO 2.- AUTORIZAR, al Señor Alcalde de la Municipalidad Provincial de Barranca, a que en representación del Concejo Municipal lleve a cabo la Suscripción del presente Convenio.
- ARTICULO 3.- ENCARGAR a la Gerencia Municipal, a la Gerencia de Servicios Públicos y demás Áreas pertinentes, el cumplimiento del presente Acuerdo.

Dado en la Casa Municipal, a los Veintidós días del mes de Junio del Dos Mil Dieciséis.

RÉGISTRESE, COMUNÍQUESE Y CÚMPLASE:

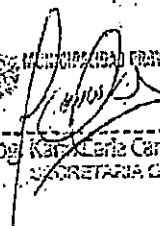
MUNICIPALIDAD PROVINCIAL DE BARRANCA

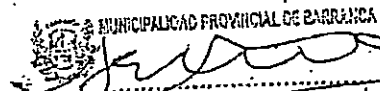
 Karla Leticia Carhuapoma Rojas
 SECRETARIA GENERAL

MUNICIPALIDAD PROVINCIAL DE BARRANCA

 Dr. José Elgar Murreros Saucedo
 ALCALDE

"TODOS POR LA SEGURIDAD... TODOS POR LA VIDA"

Jr. ZAVALA N°500 - TELE: 235 2146



"Año de la Consolidación del Mar de Grau"

ACUERDO DE CONCEJO

Nº 057-2016-AL/CPB

EL ALCALDE DE LA MUNICIPALIDAD PROVINCIAL DE BARRANCA;

VISTO: En Sesión extraordinaria del Concejo Municipal, de fecha 22 de Junio del 2016, referente a la APROBACIÓN DE LA SUSCRIPCIÓN DEL "CONVENIO INTERINSTITUCIONAL ENTRE LA MUNICIPALIDAD PROVINCIAL DE BARRANCA Y LA EMPRESA AGRICULTURA Y SERVICIOS S.R.L. - AGRYS SRL EN RELACION A LA GESTIÓN DEL MANEJO DE RESIDUOS SÓLIDOS EN LA DISPOSICIÓN FINAL" y;

CONSIDERANDO:

Que, los Gobiernos Locales gozan de autonomía política, económica y administrativa en los asuntos de su competencia. La autonomía que la Constitución Política del Perú, establece para las Municipalidades radica en la facultad de ejercer actos de gobierno, administrativo y de administración con sujeción al ordenamiento jurídico.

Que, según el Numeral 26 del Artículo 9º de la Ley Orgánica de Municipalidades, Ley Nº 27972, "Corresponde al concejo Municipal Aprobar la Celebración de convenios de cooperación nacional e internacional y convenios interinstitucionales"

Que, la Ley Nº 28411 - Ley General del sistema Nacional de Presupuesto en su Artículo 6º establece: "La Oficina de Presupuesto o la que haga sus veces es responsable de conducir el Proceso Presupuestario de la entidad, sujetándose a las disposiciones que emita la dirección Nacional del Presupuesto Público, para cuyo efecto, organiza, consolida, verifica y presenta la información que se genere así como coordina y controla la información de ejecución de Ingresos y gastos autorizados en los Presupuestos y sus modificaciones, los que constituyen el marco límite de los créditos presupuestarios aprobados".

Que, mediante ROF. 1457-2016, el Sr. Ángel Torres Visitación, Gerente General de la Empresa Agricultura y Servicios S.R.L., presenta ante la entidad edil la propuesta de convenio entre la Municipalidad Provincial de Barranca y la Empresa AGRYS SRL, con la finalidad de poder seguir realizando una adecuada gestión y manejo de los residuos sólidos está sujeto al cumplimiento de la Ley General de residuos sólidos Nº 27314 y su reglamento.

Que, al respecto con el Informe Nº 062-2016-GSP/MAC-MPB, el Gerente de Servicios Público efectúa el informe técnico respecto a la presente propuesta de convenio, asimismo el Gerente de Asesoría Jurídica a través del Informe Legal Nº 786-2016-GAJ/MPB, que señala que resulta viable la suscripción del Convenio, debiéndose tomar en cuenta que la Municipalidad no cuenta con un vertedero manual ni mecanizado, menos aun con un relleno sanitario manual, por lo que dicho convenio resulta necesario para la atención, mejora y manejo de los residuos sólidos en salvaguarda de la salud pública y por una gestión adecuada de los mismos.

Que, en sesión de Concejo de fecha 17 de Junio del 2016, el Pleno del Concejo resuelve a través del Acuerdo de Concejo Nº 051-2016-AL/CPB, lo siguiente: REQUERIR a los regidores que conforman la Comisión de Servicios Públicos evaluar el convenio Interinstitucional entre la Municipalidad Provincial de Barranca y la Empresa Agricultura y Servicios S.R.L. (AGRYS) en relación de gestión y manejo de residuos sólidos en la disposición final, conforme al marco normativo vigente y como resultado del debate de la presente sesión, la misma que deberá ser integrado a la sesión extraordinaria de fecha 24 de Junio de 2016.

"TODOS POR LA SEGURIDAD... TODOS POR LA VIDA"

Jr. ZAVALA Nº 500 - TELF: 235 2146



MINISTERIO DE SALUD
PERU
DIGESA
DIRECCION GENERAL DE
SALUD AMBIENTAL

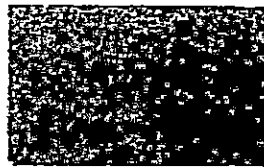

0000231

Reg. ECNB-1806.16

EXP. N°: 56565-2015-EC
Informe n.° 105-2016/DSB/DIGESA
SUCE n.° 2015435800

**REGISTRO
EMPRESAS COMERCIALIZADORAS DE RESIDUOS SÓLIDOS
(EC-RS)**

- A. EMPRESA**
Razón Social : **AGRICULTURA Y SERVICIOS SOC.COM.RESP.LTD**
N.° RUC : **20488240642**
Representante Legal : **Ángel Hermenegildo Segundo Torres Visitación**
- B. DOMICILIO**
Legal y planta : **Prolongación Ferrocarril CC.PP. Reparición, distrito y provincia de Barranca y departamento de Lima.**

C. ACTIVIDADES OPERATIVAS

MERCADO NACIONAL	
AMBITO NO MUNICIPAL	
	Código
Recolección de residuos sólidos no peligrosos de origen industrial.	IN-1
Transporte de residuos sólidos no peligrosos de origen industrial.	IN-2
Recolección de residuos sólidos no peligrosos de origen de instalaciones o actividades especiales.	IE-1
Transporte de residuos sólidos no peligrosos de origen de instalaciones o actividades especiales.	IE-2

D. REGISTRO

La Dirección de Saneamiento Básico de la Dirección General de Salud Ambiental (Digesa) emite la presente Constancia de Inscripción en el Registro de Empresas Comercializadoras de Residuos Sólidos (EC-RS), a favor de la empresa **AGRICULTURA Y SERVICIOS SOC.COM.RESP.LTD** para el desarrollo de las actividades descritas, bajo las siguientes condiciones:

1. La empresa es responsable que las actividades registradas en el ítem C se realicen cumpliendo la Ley General de Residuos Sólidos; Ley N° 27314 y su Reglamento, aprobado por D.S. N° 057-2004-PCM.
2. El Registro podrá ser anulado al verificarse el incumplimiento de los requisitos establecidos en las normas específicas.
3. Las actividades de la empresa están sujetas a vigilancia sanitaria por parte de la autoridad de salud, en caso de constatar que la empresa realiza actividades diferentes a los señalados en el ítem C, se procederá a la cancelación del presente Registro
4. El registro tiene vigencia de cuatro (04) años y no constituye autorización de funcionamiento u operación.

Lima. 11 ENE. 2016



STF/EMB/ETS



MINISTERIO DE SALUD
Dirección General de Salud Ambiental
Dirección de Saneamiento Básico
"DIGESA"

Lc. SUSALEN TANG FLORES
Directora Ejecutiva



"AÑO DEL BUEN SERVICIO AL CIUDADANO"

000-3000004

EL GERENTE DE SERVICIO PÚBLICO DE LA MUNICIPALIDAD PROVINCIAL DE BARRANCA

OTORGA LA SIGUIENTE:

A U T O R I Z A C I O N

Que, otorga la Gerencia de Servicio Públicos, en mérito a la Ley N° 27314-Ley General de Residuos Sólidos y de conformidad con lo establecido en la Ley Orgánica de Municipalidades - Ley N° 27972, describe: Las Municipalidades Provinciales son responsables de la Gestión de los Residuos Sólidos de origen domiciliario, comercial y de aquellas actividades que generan residuos similares en todo el ámbito de la jurisdicción y al Acuerdo de Concejo N° 057-2016-AL/CPB, al CONVENIO INTERINSTITUCIONAL ENTRE LA MUNICIPALIDAD PROVINCIAL DE BARRANCA Y LA EMPRESA AGRICULTURA Y SERVICIOS S.R.L. EN RELACION DE GESTION Y MANEJO DE RESIDUOS SOLIDOS EN LA DISPOSICION FINAL.

En tal sentido, se autoriza a la Empresa AGRYS S.R.L., ejercer la actividad de arrojar los residuos sólidos domiciliarios, comerciales e industriales al vertedero controlado municipal en el KM 214 - 216, de jurisdicción del Distrito de Paramonga, Provincia de Barranca, Departamento de Lima.

Se otorga la presente para los fines consiguientes.

Barranca, 22 de Junio del 2016.

MUNICIPALIDAD PROVINCIAL DE BARRANCA

Lic. Miguel Ángel Cabello Altamirano
Gerencia de Servicios Públicos

 CONSORCIO MARÍTIMO DEL NORTE	CONSORCIO MARÍTIMO DEL NORTE			
	MEJORAMIENTO Y RECUPERACION DE LOS SERVICIOS DEL DESEMBARCADERO PESQUERO ARTESANAL DE SUPE, DISTRITO DE SUPE PUERTO, PROVINCIA DE BARRANCA, REGIÓN LIMA			
	Tipo de Documento	N°	Mes	Fecha
	Valorización	18	Febrero	28/02/2019

000129

2.3 AVANCE FISICO DE OBRA

 CONSORCIO MARÍTIMO DEL NORTE
 DESEMBARCADERO ARTESANAL DE SUPE

DANIEL JOAQUÍN MORALES VIVA NCO
 RESIDENTE DE OBRA
 REG. CIP N° 98098

 <p>CONSORCIO MARITIMO DEL NORTE</p>	CONSORCIO MARÍTIMO DEL NORTE			
	MEJORAMIENTO Y RECUPERACION DE LOS SERVICIOS DEL DESEMBARCADERO PESQUERO ARTESANAL DE SUPE, DISTRITO DE SUPE PUERTO, PROVINCIA DE BARRANCA, REGIÓN LIMA			
	Tipo de Documento	N°	Mes	Fecha
	Valorización	18	Febrero	28/02/2019

IV. Control DE CALENDARIOS DE ADQUISICION DE MATERIALES

 CONSORCIO MARITIMO DEL NORTE
 DESEMBARCADERO ARTESANAL DE SUPE

DANIEL JOAQUIN MORALES VIVANCO
 RESIDENTE DE OBRA
 REG. CIP N° 98098

Obra : MEJORAMIENTO Y RECUPERACION DE LOS SERVICIOS DEL DESEMBARCADERO PESQUERO ARTESANAL DE SUPE, DISTRITO DE SUPE PUERTO, PROVINCIA DE BARRANCA, REGION LIMA
 Cliente : FONDO NACIONAL DE DESARROLLO PESQUERO - FONDEPES
 Ubicación : LIMA - BARRANCA - SUPE
 Fecha : 18/12/2018

CALENDARIO DE MATERIALES

Código	Recursos	Unidad	Cantidad	Precio Ú.	Parcial Ú.	Sep-17	Oct-17	Nov-17	Dic-17	Ene-18	Feb-18	Mar-18	Abr-18	May-18	Jun-18	Jul-18	Ago-18	Sep-18	Oct-18	Nov-18	Dic-18	TOTAL		
0272010007	TUERCA CON FLETRIA	und	13,2873	2.57	33.93																		33.93	
0272010008	TUBO GALVANIZADO DE 1 M2, E=3mm	m	278.8774	16.94	4,725.16																		4,725.16	
0272010009	TUERCA Fx.Ga. 1"	und	10,1557	0.51	5.24								4,781.18										4,781.18	
0272040002	VARILLA DE COBRE DE 3/4" X 2.40 m	und	13,8517	277.33	3,140.74				8.34														8.34	
0272040003	CONECTOR ANDERSON 3/4"	und	8,8100	3.52	30.80									1,086.62									1,086.62	
0272040005	CABLE DE COBRE DESNUDO 11mm2	m	120.9821	7.69	926.35									826.35									926.35	
0272040050	CONECTOR DE COBRE TIPO ANDERSON DE 3/4"	und	4,0327	8.32	33.56									33.56									33.56	
0272050009	TERMINAL ES DE COBRE ESTIARO TIPO U 4mm	und	2,0378	1.87	3.81									5.07									5.07	
0272050010	TERMINAL UNIPOLAR PARA CABLE SECO 25mm2, 18V	und	8,8491	0.60	5.31										40.47								40.47	
0272050011	VARILLA DE ARBOL PREFORMADA SIMPLE PACABLE DE 35 mm2	und	8,0491	222.06	1,780.09									1,346.69									1,346.69	
02730100020602	CONECTOR DE PVC DE 3/4"	und	3,0375	10.07	30.56									30.56									30.56	
02730100020604	CONECTOR DE ALUMINO DOBLE VIA PACABLE DE 35 50 mm2	und	947.1659	1.33	1,258.95									563.39									563.39	
0273010001100202	TABLERO AUTOSOPORTADO TRAFASICO CITIJI	und	3,0375	8.32	25.27									25.27									25.27	
02780100011	HOJA DE SIERRA	und	1,0982	8,690.08	9,734.73										8,734.73								8,734.73	
02900200034	ELABORACION DE EXPEDIENTE DE FRANJA DE SERVOLOMERS	und	22,1442	29.85	661.00			384.02	795.08														661.00	
02900200034	UTILIZACION DE ELASION DE POLVO	caj	1,0187	2,846.00	2,846.78					3,520.40													3,520.40	
02900800003	TIJAS	und	8,8119	7.05	62.03																		62.03	
02901000020618	PERFIL DE ALUMBRIO 1" X 1" X 1/8"	m	185,1273	8.21	1,520.29	118.40	352.93	311.87	352.23	352.05	294.33	351.88	303.07	351.20	145.07								1,520.29	
02901000020617	PERFILES DE ACERO PARA MARCOS	m	86,8928	43.82	3,787.34																		3,787.34	
02901000020618	REGLA DE MADERA	m2	1,309.9978	4.17	5,462.78																		5,462.78	
02901000020619	PERFILES DE ALUMBRIO H	m	71,0550	11.59	812.82																		812.82	
02901000020620	PERFILES METALICO SEGUN DISEÑO	und	827,1145	5.22	4,318.54																		4,318.54	
02901000020621	SERVICIO DE CAPACITACION DE USO Y MANTENIMIENTO	und	2,0104	938.73	1,887.69																		1,887.69	
0290130002	DEPOSITOS DE RESIDUOS	und	10,6358	3,882.25	41,114.63																		41,114.63	
0290150009	CONTENEDORES DE POLIETILENO DE 1000 LITROS	und	3,0107	1,691.33	5,092.14																		5,092.14	
0290150010	CONTENEDORES DE POLIETILENO RODANTE DE 300 LITROS	und	5,0170	658.67	3,295.19																		3,295.19	
0290150011	CARGETAS HORCAICAS CARGA 2500 KG	und	8,0218	8,734.13	69,948.26																		69,948.26	
0290150012	TRANSPALETA ELECTRICA INOXIDABLE DE 27M	und	2,0072	7,871.03	15,808.06																		15,808.06	
0290150013	PANDELA DE PLASTICO GRP. 1200 KG (PVC. SUBM. COLOC)	und	33,1073	313.94	10,396.83																		10,396.83	
0290150014	CAJAS DE PLASTICO CAP 40 KG (PVC. SUBM. COLOC)	und	100,3578	78.25	7,852.27																		7,852.27	
0290150015	ESTANTES PARA VESTUARIOS (PVC. SUMA. SOLOG. ACC)	m	26,1870	969.54	25,380.40																		25,380.40	
0290150016	BANCAS DE MADERA DE 1.80X.4m	caj	5,0179	358.05	1,800.87																		1,800.87	
0290150017	MODULO PARA TV	und	1,0038	318.82	318.86																		318.86	
0290150018	CONTENEDOR METALICO PARA BASURA	und	20,3250	243.80	4,956.67	3,302.27	1,443.71																4,956.67	
0290220009	SUBMINISTRO EQUIPAMIENTO PRIMEROS AUXILIOS	und	1,8150	1,744.19	3,155.32																		3,155.32	
0290220010	SUBMINISTRO EQUIPOS EXTINTORES	und	4,0960	495.11	2,028.35																		2,028.35	
0290240004100003	TRANSFORMADOR MIXTO DE TENSION	und	1,0125	11,123.44	11,272.47																		11,272.47	
0290250000	MESA DE MELANGE 206 X 180	caj	1,0038	1,265.85	1,269.57							11,272.47											1,269.57	
0290250001	ARMARIO 1.80 X 0.80 X 0.40m	und	3,8157	791.00	3,018.40																		3,018.40	
0290250002	SILLAS DE CONFERENCIA 10 CUERPOS	und	20,0715	472.47	9,480.20																		9,480.20	
0290250003	ARCHIVADOR 4 GABETAS	und	4,0143	454.37	1,823.84																		1,823.84	
0290250004	SILLAS FIJAS	caj	12,0420	91.20	1,098.04																		1,098.04	
0290250005	EGG FUTORIO EN L (1.80X0.70m)	und	4,0143	1,016.14	4,071.14																		4,071.14	
0290250006	SILLON GIRATORIO CON BRAZO DE METAL Y TAPIZADO	caj	4,0143	543.05	2,170.07																		2,170.07	
0290250007	MESA DE PLASTICO 6/6X4 SILLAS	und	10,3350	268.83	2,772.53																		2,772.53	
0290250008	COMPUTADORA (Monitor, CPU, accesorios, mouse e instalacion)	caj	2,8072	4,004.02	11,238.08																		11,238.08	
0291120003	ANILAJE DE MADERA	m2	153,8753	4.98	766.31																		766.31	
						10,683,409.20	154,805.28	55,271,318.86	1,273,623.70	1,344,114.45	1,363,225.84	738,135.17	1,074,438.20	1,043,207.28	2,361,405.14	017,638.02							763.61	10,085,445.28

CONSORCIO MARITIMO DEL NORTE
DESEMBARCADERO ARTESANAL DE SUPE
 DANIEL JOAQUIN MORALES VIVANCO
 RESIDENTE DE OBRA
 REG. CIP N° 98098

000105
 000122



CONSORCIO MARÍTIMO DEL NORTE

000001

MEJORAMIENTO Y RECUPERACION DE LOS SERVICIOS DEL
DESEMBARCADERO PESQUERO ARTESANAL DE SUPE, DISTRITO DE SUPE
PUERTO, PROVINCIA DE BARRANCA, REGION LIMA

Tipo de Documento	N°	Mes	Fecha
Valorización	18	Febrero	28/02/2019

V. Control DE CALIDAD DE MATERIALES

CONSORCIO MARITIMO DEL NORTE
DESEMBARCADERO ARTESANAL DE SUPE

DANIEL JOAQUÍN MORALES VIVANCO
RESIDENTE DE OBRA
REG. CIP N° 98098



CONSORCIO MARÍTIMO DEL NORTE

MEJORAMIENTO Y RECUPERACION DE LOS SERVICIOS
DESEMBARCADERO PESQUERO ARTESANAL DE SUPE, DISTRITO DE SUPE
PUERTO, PROVINCIA DE BARRANCA, REGION LIMA

Tipo de Documento	N°	Mes	Fecha
Valorización	18	Febrero	28/02/2019

VI. CONTROL DE CALIDAD DE EQUIPOS

CONSORCIO MARITIMO DEL NORTE
DESEMBARCADERO ARTESANAL DE SUPE

DANIEL JOAQUIN MORALES VIVANCO
RESIDENTE DE OBRA
REG. CIP N° 98098



Obra : MEJORAMIENTO Y RECUPERACION DE LOS SERVICIOS DEL DESEMBARCADERO PESQUERO ARTESANAL DE SUPE, DISTRITO DE SUPE PUERTO, PROVINCIA DE BARRANCA, REGION LIMA

Ciudad : FONDO NACIONAL DE DESARROLLO PESQUERO - FONDEPES

Ubicacion : LIMA - BARRANCA - SUPE

18/12/2018

CALENDARIO DE MATERIALES

Table with columns: Código, Recurso, Unidad, Cantidad, Precio B, Parcial B, and monthly columns from Set-17 to Dic-10, plus a TOTAL column. Lists materials like EQUIPOS, NIVEL, TEODOLITO, etc.

CONSORCIO MARITIMO DEL NORTE DESEMBARCADERO ARTESANAL DE SUPE
DANIEL JOAQUIN MORALES VIVACO
RESIDENTE DE OBRA
REG. CIP N° 98098

Handwritten vertical text: 03/03/2019

Obra : MEJORAMIENTO Y RECUPERACION DE LOS SERVICIOS DEL DESEMBARCADERO PESQUERO ARTESANAL DE SUPE, DISTRITO DE SUPE PUERTO, PROVINCIA DE BARRANCA, REGION LIMA

Clase : FONDO NACIONAL DE DESARROLLO PESQUERO - FONDEPES

Ubicacion : LIMA - BARRANCA - SUPE

Fecha : 18/12/2018

CALENDARIO DE MATERIALES

Código	Recurso	Unidad	Cantidad	Precio U.	Presup. B.	Sept-17	Oct-17	Nov-17	Dic-17	Ene-18	Feb-18	Mar-18	Abr-18	May-18	Jun-18	Jul-18	Ago-18	Sep-18	Oct-18	Nov-18	Dic-18	TOTAL	
030120000004	MEZCLADORA DE CONCRETO TAMBOR 18 HP 11p3	hm	1330.8840	12.00	30,143.60	547.40	501.83	1,023.42	3,595.08	6,818.71	4,096.78	8,878.60	942.21	2,454.59	1,305.10								30,143.60
0301200008	MESAS DE ACERO INOXIDABLE PARA 03 PERSONAS	cb	7.0250	6,853.12	48,143.41										48,143.41							48,143.41	
0301330008	EQUIPO DE CORTE	hm	958.1747	8.85	8,483.69	278.41	3,871.47	154.10	744.48	801.11	1,073.28	819.33	563.43	212.23	20,414.21							8,483.69	
0301330009	EQUIPO DE CORTE Y SOLDADO	hm	2,304.0872	8.85	20,414.21										20,414.21							20,414.21	
0301330010	EQUIPO DE SOLDAR	hm	2,483.5882	16.81	41,819.87							2,058.83		552.65	38,278.89							41,819.87	
0301330011	CIZALLA PARA CORTE DE FERRO	hm	320.8053	32.14	10,332.24	828.85	4,259.47	120.71														10,332.24	
0301330012	CIZALLA P/ FERRO CONST. HASTA 1"	unad	61.5780	8.85	608.48									608.48								608.48	
0301330013	CIZALLA P/ CORTE CABLE ELECTRICO	hm	6.9040	5.54	38.25							3.35										38.25	
0301340008	ANDAMIO METALICO	cta	877.8250	8.64	5,829.81								5,829.83									5,829.83	
0301340009	ANDAMIO METALICO	hm	61.3568	13.98	854.82							50.34		784.48								854.82	
0301340010	ANDAMIO METAL TABLAS ALZUELER	est	1,263.1704	22.14	28,019.87									2,503.98								28,019.87	
0301340011	PLAT. AFORMA PARA RETENCION DE MATERIAL DE ELEVACION	hm	8.6021	6,859.88	58,777.33	9,265.69	47,618.65	1,492.08														58,777.33	
0301430002	TECLE 2 Ton TRIPODE	hm	61.3568	11.19	685.58																	685.58	
0301430003	TECLE 5 Ton, INC. TRIPODE	hm	32.2819	70.87	2,288.40							42.42		644.16								2,288.40	
0301440001	DOBLADORA DE TUB. FERRO	hm	32.8373	18.81	618.26																	618.26	
0301500001	MOVILIZACION Y DESMOVILIZACION	cb	1,0183	42,883.69	43,747.83	43,747.83																43,747.83	
0303010002	DESMANTELAMIENTO DE ESTRUCTURAS PROVISIONALES	cb	1.0031	3,118.01	3,118.01																	3,118.01	
0304010001	TRANSPORTE DE MATERIALES	hm	3,587.4458	85.82	307,554.84	11,873.03	28,728.58	29,564.11	20,874.44	30,728.08	27,781.20	30,827.28	28,093.42	30,892.33	12,784.82							307,554.84	
					2,188,654.00	93,127.35	234,250.38	592,631.82	125,690.72	287,124.93	260,884.91	161,591.30	81,061.60	277,450.94	218,433.35								2,188,654.00

CONSORCIO MARITIMO DEL NORTE
DESEMBARCADERO ARTESANAL DE SUPE
DANIEL JOAQUIN MORALES VIVAYCO
RESIDENTE DE OBRA
REG. CIP N° 98098

000130
000118



CONSORCIO MARÍTIMO DEL NORTE

06-2019

MEJORAMIENTO Y RECUPERACION DE LOS SERVICIOS DEL
DESEMBARCADERO PESQUERO ARTESANAL DE SUPE, DISTRITO DE SUPE
- PUERTO, PROVINCIA DE BARRANCA, REGIÓN LIMA

Tipo de Documento	N°	Mes	Fecha
Valorización	18	Febrero	28/02/2019

VII. CONTROL Y PREVENCIÓN DE RIESGOS (SEGURIDAD)

CONSORCIO MARITIMO DEL NORTE
DESEMBARCADERO ARTESANAL DE SUPE

DANIEL JOAQUIN MORALES VIVAS
RESIDENTE DE OBRA
REG. CIP N° 98098

INFORME MENSUAL

GESTIÓN SSOMA

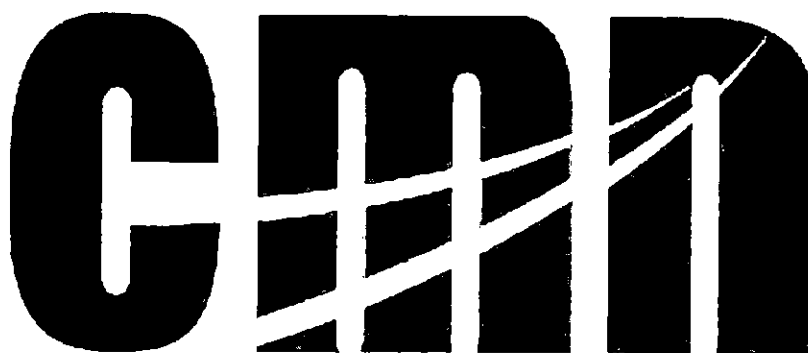

CONSORCIO MARITIMO DEL NORTE

**"Mejoramiento y Recuperación de los Servicios del
Desembarcadero Pesquero Artesanal de Supe, Distrito
de Supe Puerto, Provincia de Barranca, Región Lima"**

FEBRERO

2019

CONSORCIO MARITIMO DEL NORTE
DESEMBARCADERO ARTESANAL DE SUPE

Franklin Alfonso Mejía Acosta
ING. SEG. Y MEDIO AMBIENTE
CIP. 45497

CONSORCIO MARITIMO DEL NORTE
DESEMBARCADERO ARTESANAL DE SUPE
Daniel Joaquín Morales Viva NCO
RESIDENTE DE OBRA
REG. CIP N° 98098

Departamento SSOMA

 <p>CONSORCIO MARÍTIMO DEL NORTE</p>	CONSORCIO MARÍTIMO DEL NORTE			000115
	INFÓRME DE SSOMA			
	Tipo de Documento	Mes	Fecha	Revisión
Informe	Febrero	28/02/2019	00	

CONTENIDO

1. ANTECEDENTES:
2. GESTION EN SALUD OCUPACIONAL:
 - 2.1. EXAMENES OCUPACIONALES
3. CHARLAS DE SEGURIDAD:
 - 3.1. CHARLAS DE INDUCCION
 - 3.2. CHARLAS DE INICIO DE JORNADA
 - 3.3. CAPACITACION EN PREPARACION Y RESPUESTA ANTE EMERGENCIAS
4. SEGURIDAD EN LA EJECUCION DE OBRA:
 - 4.1. EXCAVACION CON MAQUINA
 - 4.2. HABILITADO Y COLOCADO DE ACERO
 - 4.3. ENCOFRADO Y DESENCOFRADO
 - 4.4. VACIADO DE CONCRETO
 - 4.5. ALBAÑILERIA / TARRAJEO / ENCHAPE DE CERAMICO
 - 4.6. PINTURA
5. INSPECCIONES:
 - 5.1. INSTALACIONES
 - 5.2. EXTINTORES Y BOTIQUINES
 - 5.3. AREA OPERATIVA - OBRA

ANEXOS:

1. ANEXO 1.
 - Índice.
 - Horas hombre.
 - Capacitación.
 - Estadísticas.
 - Reporte de incidentes.
 - Resumen de gestión.
 - Conclusiones.
 - Relación de personal – Categoría – HH – HM
 - Check de equipos y maquinarias
2. ANEXO 2.
 - Exámenes médicos pre ocupacionales.
 - Seguro complementario de Trabajo de Riesgo.
 - Registros de charlas de Inducción Trabajador Nuevo.
 - Registros de charlas de Inicio de Jornada.
 - Registros de capacitaciones.
 - Registros de AST.
 - Registros de Permiso de Alto Riesgo.
 - Check List.
 - Inspecciones.
 - Entrega de Epp's.

CONSORCIO MARITIMO DEL NORTE
DESEMBARCADERO ARTESANAL DE SUPE

Franklin Alfonso Mejía Acosta
ING. SEG. Y MEDIO AMBIENTE
CIP. 45497

CONSORCIO MARITIMO DEL NORTE
DESEMBARCADERO ARTESANAL DE SUPE

DANIEL JOAQUIN MORALES VIVA YCO
RESIDENTE DE OBRA
REG. CIP N° 98098

 CONSORCIO MARÍTIMO DEL NORTE	CONSORCIO MARÍTIMO DEL NORTE			
	INFORME DE SSOMA			
	Tipo de Documento	Mes	Fecha	Revisión
Informe	Febrero	28/02/2019	00	

INFORME DE SEGURIDAD, SALUD Y MEDIO AMBIENTE

1. ANTECEDENTES:

En este mes de febrero se continuaron con las actividades de la obra: "Mejoramiento y Recuperación de los Servicios del Desembarcadero Artesanal de Supe, Distrito de Supe Muelle, Provincia de Barranca, Región Lima" .

De acuerdo al plan de seguridad, salud y medio ambiente, se programaron las actividades como exámenes de salud ocupacional, Inducción al trabajador nuevo, inclusión en el SCTR, etc.

En este mes de febrero se ejecutaron las siguientes partidas del contrato:

- EXCAVACION CON MAQUINA
- HABILITACION Y COLOCADO DE ACERO
- ENCOFRADO Y DESENCOFRADO
- VACIADO DE CONCRETO
- ALBAÑILERIA / TARRAJEO
- PINTURA

2. GESTION EN SALUD OCUPACIONAL:

2.1. EXAMENES OCUPACIONALES

De acuerdo con la RM 312-2011 MINSA – Protocolos de Exámenes Médico Ocupacionales, se llevó a todos los postulantes a ingresar a trabajar este mes para ser evaluados por clínicas ocupacionales para el puesto al que postulaban; siendo contratados aquellos que no presentaban ninguna deficiencia de salud para dicho puesto.

3. CHARLAS DE SEGURIDAD:

3.1. CHARLAS DE INDUCCION

Se procedió a dar las charlas de inducción para trabajador nuevo, según fueron ingresando, conteniendo los siguientes temas:

1. Introducción, bienvenida y presentación.
2. Legislación nacional en seguridad.
3. Difusión y explicación de la Política de Seguridad, Salud y Medio Ambiente.
4. Organigrama del Proyecto.
5. Obligación de los trabajadores.
6. Plan de Seguridad de la Obra.
7. Plan de Respuesta ante Emergencia.
8. Procedimientos de Trabajo.

CONSORCIO MARÍTIMO DEL NORTE
DESEMBARCADERO ARTESANAL DE SUPE

Franklin Alfonso Mejía Acosta
ING. SEG. Y MEDIO AMBIENTE
CIP. 45497

CONSORCIO MARÍTIMO DEL NORTE
DESEMBARCADERO ARTESANAL DE SUPE
DANIEL JOAQUÍN MORALES VIVARICO
RESIDENTE DE OBRA
REG. CIP N° 98098

 CONSORCIO MARÍTIMO DEL NORTE	CONSORCIO MARÍTIMO DEL NORTE			
	INFORME DE SSOMA			
	Tipo de Documento	Mes	Fecha	Revisión
Informe	Febrero	28/02/2019	00	

9. Análisis de Seguridad de Trabajo (A.S.T.).
10. Reunión de inicio de jornada.
11. Equipos de Protección Personal y Colectiva.
12. Orden y Limpieza en las zonas de trabajo.
13. Identificación de Peligros y Evaluación de Riesgos.
14. Acto y Condición subestándar.
15. Accidente, Incidente y Enfermedad Ocupacional.
16. Causa de los accidentes e incidentes.
17. Investigación y Reporte de Accidentes e Incidentes.
18. Primeros Auxilios.



CHARLAS DE INDUCCION AL TRABAJADOR NUEVO

3.2. CHARLAS DE INICIO DE JORNADA:

La asistencia a esta charla de inducción se encuentra debidamente registradas para su revisión.

Las charlas de seguridad diarias antes de empezar las labores empiezan a las 7:15 hasta las 7:30 am. y este mes se expusieron los siguientes temas:

CONSORCIO MARITIMO DEL NORTE
DESEMBARCADERO ARTESANAL DE SUPE

Franklin/Alfonso Mejia Acosta
ING. SEG. Y MEDIO AMBIENTE
CIP. 45497

CONSORCIO MARITIMO DEL NORTE
DESEMBARCADERO ARTESANAL DE SUPE

Daniel Joaquín Morales Viva y Co.
RESIDENTE DE OBRA
REG. CIP N° 98098

00-112

 <p>CONSORCIO MARÍTIMO DEL NORTE</p>	CONSORCIO MARÍTIMO DEL NORTE			
	INFORME DE SSOMA			
	Tipo de Documento	Mes	Fecha	Revisión
	Informe	Febrero	28/02/2019	00

PROGRAMACION DE CHARLAS DIARIAS DE INICIO DE JORNADA DEL MES DE FEBRERO 2019:

SEMANA	LUNES	MARTES	MIERCOLES	JUEVES	VIERNES	SABADO
Del 04 al 10Feb	Protección auditiva	Seguridad con las instalaciones eléctricas	Herramientas de mano	Mantener limpio el sito de trabajo	Equipo de protección personal	Prevencciones de lesiones de espalda
Del 11 al 17Feb	Los accidentes no son casuales	Inspecciones	Los avisos tienen un significado	La seguridad es cosa personal	Las bromas pesadas son peligrosas	Protejan sus manos
Del 18 al 24Feb	Seguridad vs felicidad	Ambiente de trabajo	Esta en sus manos	Mango de herramientas	Actitudes inseguras o factores humanos que causan accidentes	Dígale no a los actos inseguros
Del 25Feb al 03Mar	Asignación de trabajo seguro (ATS/AST)	Autodisciplina="Una forma para alcanzar la seguridad"	La union hace la fuerza	Aguafiestas	Mirar siempre antes de actuar	Orgullo en el trabajo

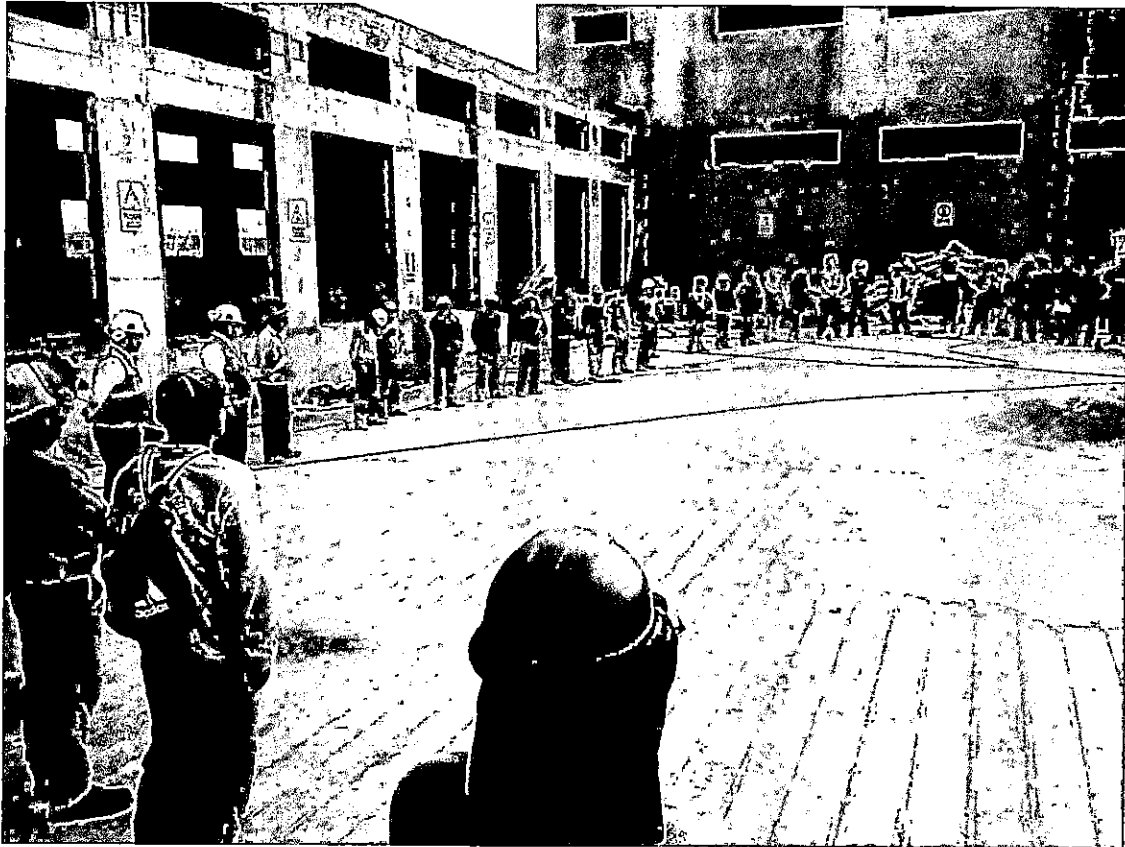

CHARLA DE INICIO DE JORNADA

CONSORCIO MARITIMO DEL NORTE
DESEMBARCADERO ARTESANAL DE SUPE

Franklin Alfonso Mejia Acosta
ING. SEG. Y MEDIO AMBIENTE
CIP. 45497

CONSORCIO MARITIMO DEL NORTE
DESEMBARCADERO ARTESANAL DE SUPE

DANIEL JOAQUIN MORALES VIVAS
RESIDENTE DE OBRA
REG. CIP N° 98098

	CONSORCIO MARÍTIMO DEL NORTE			
	INFORME DE SSOMA			
	Tipo de Documento	Mes	Fecha	Revisión
	Informe	Febrero	28/02/2019	00



DINAMICA EN LA CHARLA DE INICIO DE JORNADA

3.3. CAPACITACION EN PREPARACION Y RESPUESTAS ANTE EMERGENCIAS:

De acuerdo al programa de Seguridad, Salud Ocupacional y Medio Ambiente se desarrolló la capacitación y respuesta ante emergencias el 21 de febrero a las 7:00 hrs, a cargo del Ing. Franklin Mejía Acosta, con CIP N° 45497.



CAPACITACION EN EQUIPOS DE PROTECCION PERSONAL EN OBRAS CIVILES

CONSORCIO MARÍTIMO DEL NORTE
DESEMBARCADERO ARTESANAL DE SUPE

Franklin Alfonso Mejía Acosta
ING. SEC. Y MEDIO AMBIENTE
CIP. 45497

CONSORCIO MARÍTIMO DEL NORTE
DESEMBARCADERO ARTESANAL DE SUPE

Daniel Joaquín Morales Vivero
DANIEL JOAQUÍN MORALES VIVERO
RESIDENTE DE OBRA
REG. CIP N° 98098

 CONSORCIO MARÍTIMO DEL NORTE	CONSORCIO MARÍTIMO DEL NORTE			
	INFORME DE SSOMA			
	Tipo de Documento	Mes	Fecha	Revisión
Informe	Febrero	28/02/2019	00	

4. SEGURIDAD EN LA EJECUCION DE OBRA:

El control de la seguridad, salud y medio ambiente en la obra se realizó de acuerdo a las actividades de las partidas, como sigue:

4.1. EXCAVACION CON MAQUINA

Se realizaron excavaciones para la cisterna del área de frío.

I. SEGURIDAD Y SALUD EN ESTA PARTIDA:

a) PELIGRO:

- Ruido.
- Vibración permanente.
- Partículas en suspensión.
- Tránsito vehicular.
- Posturas forzadas.

b) RIESGO ASOCIADO:

- Personal expuesto al ruido.
- Alteración al sistema locomotor.
- Inflamación de vías respiratorias.
- Derrumbes desplome.
- Volcadura, atropello, colisión.
- Alteración muscular.

c) MEDIDAS DE CONTROL:

- EPP. Polo manga larga, pantalón, Tapones y orejeras para protección auditivos, respirador de polvo.
- Difusión Procedimiento de Trabajo.
- Distancia mínima de separación vehicular, Colocación de tacos de madera o metal en unidades móviles, Ascenso y descenso adecuado de unidades móviles.
- Evaluación musculo esquelética básica, Monitoreo de riesgo disergonómico; Capacitación Ergonomía, Realizar pausas activas.

II. GESTION MEDIOAMBIENTAL:

a) IMPACTO AMBIENTAL:

- Contaminación del aire por gases CO2 por combustión de los motores de vehículos y maquinaria.

CONSORCIO MARITIMO DEL NORTE
DESEMBARCADERO ARTESANAL DE SUPE

Franklin Alfonso Mejía Acosta
ING. SEG. Y MEDIO AMBIENTE
CIP. 45497

CONSORCIO MARITIMO DEL NORTE
DESEMBARCADERO ARTESANAL DE SUPE
DANIEL JOAQUIN MORALES VIVA YCO
RESIDENTE DE OBRA
REG. CIP N° 98098

003109



CONSORCIO MARÍTIMO DEL NORTE

INFORME DE SSOMA

Tipo de Documento	Mes	Fecha	Revisión
Informe	Febrero	28/02/2019	00

- Contaminación sonora, por ruidos causados por la excavadora.
- Contaminación del aire por polvos de la excavación y carguío de desmante al volquete, etc.

b) MITIGACION:

- Mantenimiento preventivo y predictivo de la maquinaria, para minimizar la emisión de gases.
- Los equipos y unidades vehiculares tienen mantenimiento oportuno y adecuado y usan silenciadores adecuados.
- Humedecer el material a eliminar para evitar el polvo.



EXCAVACION PARA LA CISTERNA DEL AREA DE FRIO

4.3 HABILITADO Y COLOCADO DE ACERO

Se ejecutaron las actividades de habilitado y colocado de acero del cerco perimétrico:

CONSORCIO MARÍTIMO DEL NORTE
DESEMBARCADERO ARTESANAL DE SUPE

Francilín Alfonso Mejía Acosta
ING. SEG. Y MEDIO AMBIENTE
CIP. 45497

CONSORCIO MARÍTIMO DEL NORTE
DESEMBARCADERO ARTESANAL DE SUPE

DANIEL JOAQUÍN MORALES VIVIÁN ICL
RESIDENTE DE OBRA
REG. CIP N° 98098

000208

 <p>CONSORCIO MARÍTIMO DEL NORTE</p>	CONSORCIO MARÍTIMO DEL NORTE			
	INFORME DE SSOMA			
	Tipo de Documento	Mes	Fecha	Revisión
Informe	Febrero	28/02/2019	00	

I. SEGURIDAD Y SALUD EN ESTA PARTIDA:

a) PELIGRO:

- Ruido.
- Posturas forzadas.
- Objetos y equipos punzo cortantes.
- Epp's, herramientas en mal estado.
- Trabajo en altura

b) RIESGO ASOCIADO:

- Personal expuesto al ruido.
- Alteración muscular.
- Cortes.
- Descarga eléctrica.
- Caídas.

c) MEDIDAS DE CONTROL:

- EPP. Polo manga larga, pantalón, Tapones y orejeras para protección auditivos, respirador de polvo.
- Evaluación musculo esquelética básica, Monitoreo de riesgo disergonómico; Capacitación Ergonomía, Realizar pausas activas.
- Uso de Epp's adecuado para la labor, no retirar guardas de los equipos.
- Uso de arnes.

II. GESTION MEDIOAMBIENTAL:

a) IMPACTO AMBIENTAL:

- Residuos metálicos.
- Contaminación sonora, por ruidos causados por la tronadora.
- Contaminación del aire por polvos al cortar el acero, etc.

b) MITIGACION:

- Acopiar los residuos en los contenedores temporales, hasta su disposición final.
- Mantenimiento preventivo y predictivo de las tronadoras.
- Uso de mascarillas.
- Uso obligatorio de la careta facial.

CONSORCIO MARITIMO DEL NORTE
 DESEMBARCADERO ARTESANAL DE SUPE

Franklin Alfonso Mejía Acosta
 ING. SEG. Y MEDIO AMBIENTE
 CIP. 45497

CONSORCIO MARITIMO DEL NORTE
 DESEMBARCADERO ARTESANAL DE SUPE

Daniel Joaquín Morales Vivero
 DANIEL JOAQUÍN MORALES VIVERO
 RESIDENTE DE OBRA
 REG. CIP N° 98098



000107
CONSORCIO MARÍTIMO DEL NORTE

INFORME DE SSOMA

Tipo de Documento

Mes

Fecha

Revisión

Informe

Febrero

28/02/2019

00

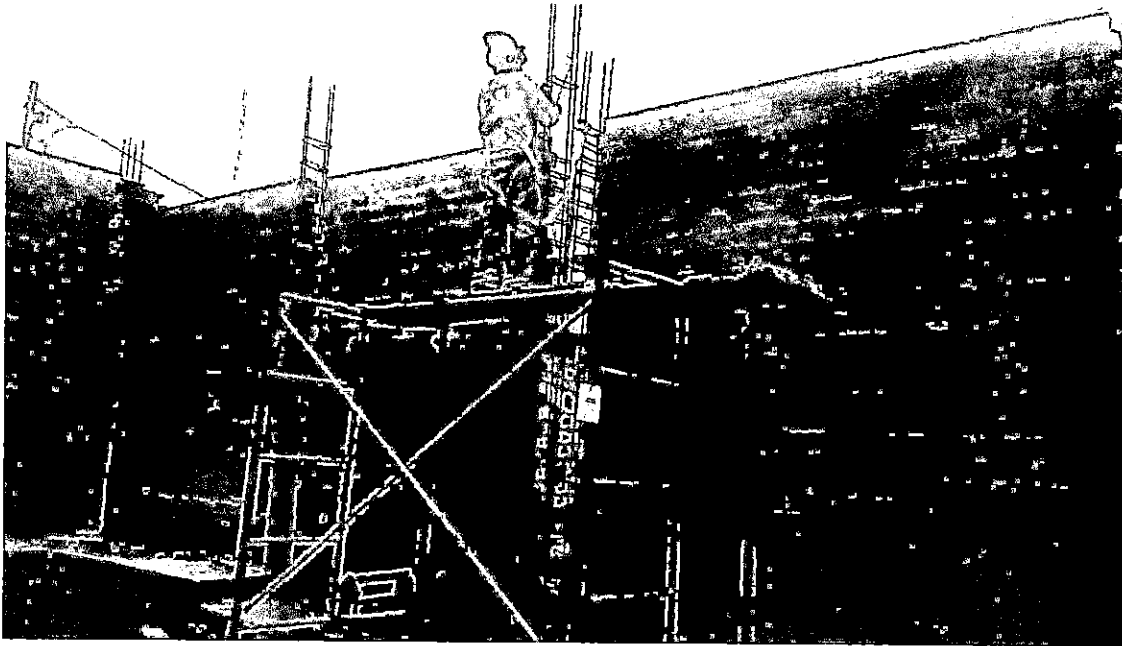

COLOCADO DE ACERO EN CERCO PERIMETRICO

4.4 ENCOFRADO Y DESENCOFRADO

Se ejecutaron las actividades de encofrado y desencofrado de cisterna:

I. SEGURIDAD Y SALUD EN ESTA PARTIDA:

a) PELIGRO:

- Ruido.
- Posturas forzadas.
- Objetos y equipos punzo cortantes.
- Epp's, herramientas en mal estado.

b) RIESGO ASOCIADO:

- Personal expuesto al ruido.
- Alteración muscular.
- Cortes.
- Descarga eléctrica.

CONSORCIO MARITIMO DEL NORTE
DESEMBARCADERO ARTESANAL DE SUPE

Franklin Alfonso Mejía Acosta
ING. SEG. Y MEDIO AMBIENTE
CIP. 45497

CONSORCIO MARITIMO DEL NORTE
DESEMBARCADERO ARTESANAL DE SUPE

DANIEL JOAQUÍN MORALES VIVA VCL.
RESIDENTE DE OBRA
REG. CIP N° 98098

 CONSORCIO MARÍTIMO DEL NORTE	CONSORCIO MARÍTIMO DEL NORTE			
	INFORME DE SSOMA			
	Tipo de Documento	Mes	Fecha	Revisión
	Informe	Febrero	28/02/2019	00

c) MEDIDAS DE CONTROL:

- EPP. Polo manga larga, pantalón, Tapones y orejeras para protección auditivos, respirador de polvo.
- Evaluación musculo esquelética básica, Monitoreo de riesgo disergonómico; Capacitación Ergonomía, Realizar pausas activas.
- Uso de Epp's adecuado para la labor, no retirar guardas de los equipos.

II. GESTION MEDIOAMBIENTAL:

a) IMPACTO AMBIENTAL:

- Residuos de madera.
- Contaminación sonora, por ruidos causados por la sierra circular de mano.
- Contaminación del aire por polvos al cortar el acero, etc.

b) MITIGACION:

- Acopiar los residuos en los contenedores temporales, hasta su disposición final.
- Mantenimiento preventivo y predictivo de las sierras circulares de mano.
- Uso de mascarillas.

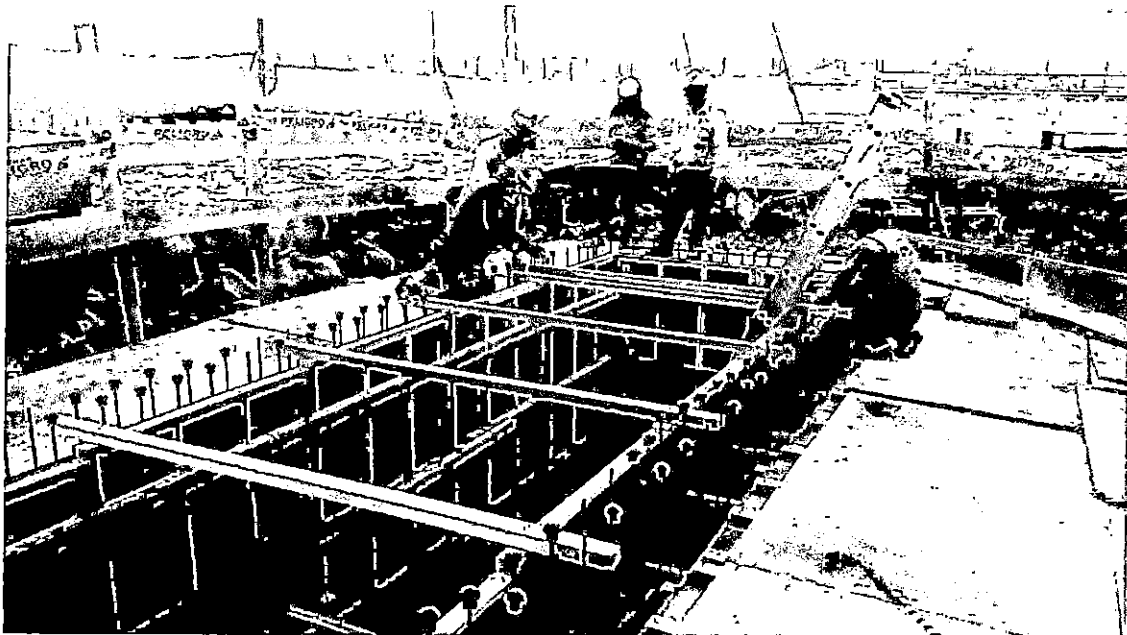

ENCOFRADO DE CISTERNA

CONSORCIO MARITIMO DEL NORTE
DESEMBARCADERO ARTESANAL DE SUPE

Franklin Alfonso Mejía Acosta
ING. SEG. Y MEDIO AMBIENTE
CIP. 45497

CONSORCIO MARITIMO DEL NORTE
DESEMBARCADERO ARTESANAL DE SUPE

Daniel Joaquín Morales Vivaico
RESIDENTE DE OBRA
REG. CIP N° 98098

000105

	CONSORCIO MARÍTIMO DEL NORTE			
	INFORME DE SSOMA			
	Tipo de Documento	Mes	Fecha	Revisión
	Informe	Febrero	28/02/2019	00

4.5 VACIADO DE CONCRETO

Se ejecutaron las actividades de vaciado de concreto de cisterna:

I. SEGURIDAD Y SALUD EN ESTA PARTIDA:

a) PELIGRO:

- Ruido.
- Vibración permanente.
- Sustancias irritantes (Gasolina, Petróleo, Cemento)
- Posturas forzadas.
- Sobreesfuerzo (carga manual).
- Herramientas / equipos en movimiento.
- Desprendimiento de partículas, fragmentos. Salpicadura de líquidos.
- Objetos y equipos punzo cortantes.
- Epp's, herramientas en mal estado.
- Trabajos en altura

b) RIESGO ASOCIADO:

- Personal expuesto al ruido.
- Alteración del sistema locomotor.
- Daños a diferentes partes de cuerpo.
- Alteración muscular.
- Atrapamiento.
- Cortes.
- Descarga eléctrica.
- Caídas

c) MEDIDAS DE CONTROL:

- EPP. Polo manga larga, pantalón, Tapones y orejeras para protección auditivos, respirador de polvo.
- Evaluación musculo esquelética básica, realizar pausas activas.
- EPP. Uso de traje de protección química, Espirometría.
- EPP. Lentes de seguridad, respiradores, guantes de jebe.
- Evaluación musculo esquelética básica, Monitoreo de riesgo disergonómico; Capacitación Ergonomía, Realizar pausas activas.
- Uso de Epp's adecuado para la labor, no retirar guardas de los equipos.
- Barandas rígidas.

CONSORCIO MARITIMO DEL NORTE
DESEMBARCADERO ARTESANAL DE SUPE

Franklin Alfonso Mejía Acosta
ING. SEG. Y MEDIO AMBIENTE
CIP. 45497

CONSORCIO MARITIMO DEL NORTE
DESEMBARCADERO ARTESANAL DE SUPE
Daniel Joaquín Morales Viva ICC
DANIEL JOAQUÍN MORALES VIVA ICC
RESIDENTE DE OBRA
REG. CIP N° 98098

002304

 <p>CONSORCIO MARÍTIMO DEL NORTE</p>	CONSORCIO MARÍTIMO DEL NORTE			
	INFORME DE SSOMA			
	Tipo de Documento	Mes	Fecha	Revisión
	Informe	Febrero	28/02/2019	00

II. GESTION MEDIOAMBIENTAL:

a) IMPACTO AMBIENTAL:

- Residuos de concreto.
- Contaminación sonora, por ruidos causados por la mezcladora de concreto.
- Contaminación del aire por polvos al abastecer la tolva de la mezcladora, etc.

b) MITIGACION:

- Acopiar los residuos en los acopios temporales, hasta su disposición final.
- Mantenimiento preventivo y predictivo de la mezcladora de concreto.
- Uso de Epp's adecuados.



PRODUCCION DE CONCRETO PARA CISTERNA

CONSORCIO MARÍTIMO DEL NORTE
 DESEMBARCADERO ARTESANAL DE SUPE

Franklin Alfonso Mejía Acosta
 ING. SEG. Y MEDIO AMBIENTE
 CIP. 45497

CONSORCIO MARÍTIMO DEL NORTE
 DESEMBARCADERO ARTESANAL DE SUPE

Daniel Joaquín Morales Vivanco
 DANIEL JOAQUÍN MORALES VIVANCO
 RESIDENTE DE OBRA
 REG. CIP N° 98098

000103



CONSORCIO MARÍTIMO DEL NORTE

INFORME DE SSOMA

Tipo de Documento	Mes	Fecha	Revisión
Informe	Febrero	28/02/2019	00



VACIADO DE CIMENTO DE CISTERNA

4.6 ALBAÑILERIA / TARRAJEO / ASENTADO DE LADRILLO

Se ejecutaron las actividades de tarrajeo y asentado de ladrillo:

I. SEGURIDAD Y SALUD EN ESTA PARTIDA:

a) PELIGRO:

- Posturas forzadas.
- Sobreesfuerzo (carga manual).
- Desprendimiento de partículas, fragmentos.
- Objetos y equipos punzo cortantes.
- Epp's, herramientas en mal estado.
- Trabajos en altura.

b) RIESGO ASOCIADO:

- Alteración del sistema locomotor.
- Daños a diferentes partes de cuerpo.
- Alteración muscular.
- Cortes.
- Caídas a diferente nivel

CONSORCIO MARÍTIMO DEL NORTE
DESEMBARCADERO ARTESANAL DE SUPE

Franklin Alfonso Mejía Acosta
ING. SEG. Y MEDIO AMBIENTE
CIP. 45497

CONSORCIO MARÍTIMO DEL NORTE
DESEMBARCADERO ARTESANAL DE SUPE

DANIEL JOAQUÍN MORALES VIVANCO
RESIDENTE DE OBRA
REG. CIP N° 98098

 CONSORCIO MARÍTIMO DEL NORTE	CONSORCIO MARÍTIMO DEL NORTE		
	INFORME DE SSOMA		
	Tipo de Documento	Mes	Fecha
Informe	Febrero	28/02/2019	00

c) MEDIDAS DE CONTROL:

- EPP. Polo manga larga, pantalón, guantes de jebe, lentes.
- Evaluación musculo esquelética básica, Monitoreo de riesgo disergonómico; Capacitación Ergonomía, Realizar pausas activas.
- Uso de andamios.
- Uso de arnés y línea de vida.

II. GESTION MEDIOAMBIENTAL:

a) IMPACTO AMBIENTAL:

- Residuos de mortero.
- Residuos de ladrillo
- Contaminación del aire por polvos al abastecer la batea, etc.

b) MITIGACION:

- Acopiar los residuos en los acopios temporales, hasta su disposición final.
- Uso de Epp's adecuados.

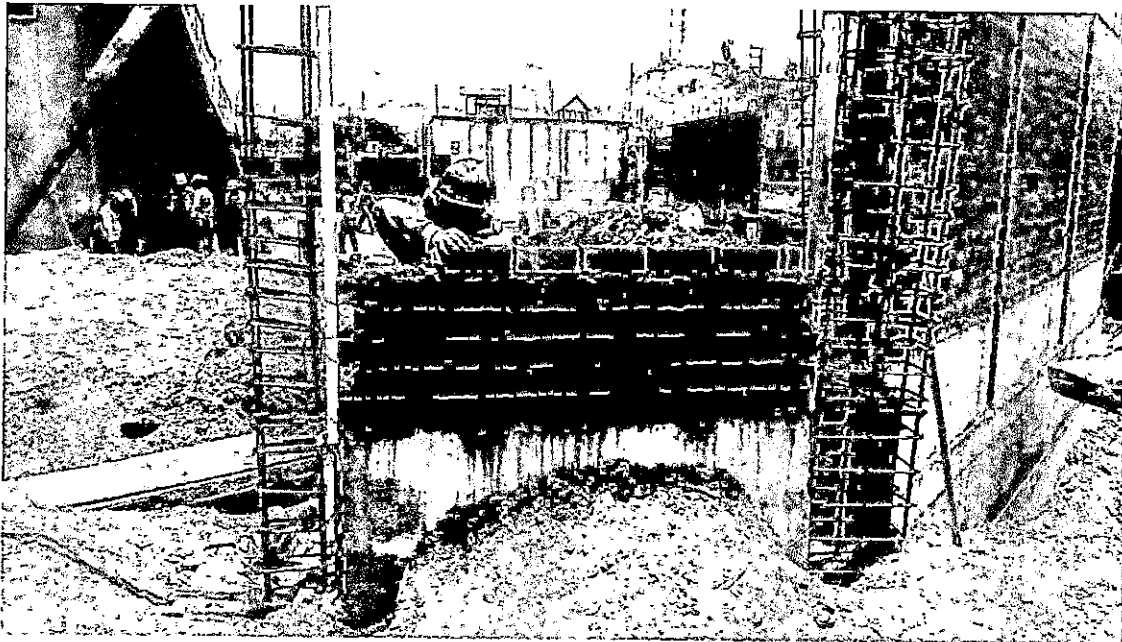

ASENTADO DE LADRILLO

CONSORCIO MARÍTIMO DEL NORTE
 DESEMBARCADERO ARTESANAL DE SUPE
 Franklin Alfonso Mejía Acosta
 ING. SEG. Y MEDIO AMBIENTE
 CIP. 45497

CONSORCIO MARÍTIMO DEL NORTE
 DESEMBARCADERO ARTESANAL DE SUPE
 DANIEL JOAQUÍN MORALES VIVAPCC
 RESIDENTE DE OBRA
 REG. CIP N° 98098

000101

	CONSORCIO MARÍTIMO DEL NORTE			
	INFORME DE SSOMA			
	Tipo de Documento	Mes	Fecha	Revisión
	Informe	Febrero	28/02/2019	00



TARRAJEO DE FACHADA ZONA DE TAREAS PREVIAS

4.7 PINTURA EN LA ZONA DE FRIO

Se ejecutaron las actividades de pintura en la zona de frío:

III. SEGURIDAD Y SALUD EN ESTA PARTIDA:

d) PELIGRO:

- Posturas forzadas.
- Sobreesfuerzo (carga manual).
- Desprendimiento de partículas, fragmentos.
- Epp's, herramientas en mal estado.
- Trabajos en altura.

e) RIESGO ASOCIADO:

- Alteración del sistema locomotor.
- Daños a diferentes partes de cuerpo.
- Alteración muscular.
- Caídas a diferente nivel

CONSORCIO MARITIMO DEL NORTE
DESEMBARCADERO ARTESANAL DE SUPE

Franklin Alfonso Mejía Acosta
ING. SEG. Y MEDIO AMBIENTE
CIP. 45497

CONSORCIO MARITIMO DEL NORTE
DESEMBARCADERO ARTESANAL DE SUPE

Daniel Joaquín Morales Vivas
DANIEL JOAQUÍN MORALES VIVAS
RESIDENTE DE OBRA
REG. CIP N° 98098

000100

 CONSORCIO MARITIMO DEL NORTE	CONSORCIO MARÍTIMO DEL NORTE			
	INFORME DE SSOMA			
	Tipo de Documento	Mes	Fecha	Revisión
Informe	Febrero	28/02/2019	00	

f) MEDIDAS DE CONTROL:

- EPP. Polo manga larga, pantalón, guantes de jebe, lentes.
- Evaluación musculo esquelética básica, Monitoreo de riesgo disergonómico; Capacitación Ergonomía, Realizar pausas activas.
- Uso de andamios.
- Uso de arnés y línea de vida.

IV. GESTION MEDIOAMBIENTAL:

c) IMPACTO AMBIENTAL:

- Residuos de pintura.
- Residuos de brochas, lijas, rodillos
- Contaminación del aire por polvos al lijar, etc.

d) MITIGACION:

- Acopiar los residuos en los acopios temporales, hasta su disposición final.
- Uso de Epp's adecuados.



PINTIURA EN LA ZONA DE FRIO

CONSORCIO MARITIMO DEL NORTE
 DESEMBARCADERO ARTESANAL DE SUPE
 Franklin Alfonso Mejía Acosta
 ING. SEG. Y MEDIO AMBIENTE
 CIP. 45497

CONSORCIO MARITIMO DEL NORTE
 DESEMBARCADERO ARTESANAL DE SUPE
 DANIEL JOAQUIN MORALES VIVARICO
 RESIDENTE DE OBRA
 REG. CIP N° 98098

000099



CONSORCIO MARÍTIMO DEL NORTE

INFORME DE S\$OMA

Tipo de Documento	Mes	Fecha	Revisión
Informe	Febrero	28/02/2019	00

5 INSPECCIONES:

5.1. INSTALACIONES:

Este mes se realizó las inspecciones a las instalaciones de la obra, de acuerdo al programa de Seguridad y Salud en el Trabajo.



PANEL INFORMATIVO S\$OMA - OFICINA



CONSORCIO MARITIMO DEL NORTE
DESEMBARCADERO ARTESANAL DE SUPE

Franklin Aronso Mejia Acosta
ING. SGG. Y MEDIO AMBIENTE
CIP. 45497

CONSORCIO MARITIMO DEL NORTE
DESEMBARCADERO ARTESANAL DE SUPE

DANIEL ISAAC RAMIREZ VIVAS
RESIDENTE DE OBRA
F.L.C. C.P. N° 95098

 CONSORCIO MARÍTIMO DEL NORTE	CONSORCIO MARÍTIMO DEL NORTE		
	INFORME DE SSOMA		
	Tipo de Documento	Mes	Fecha
Informe	Febrero	28/02/2019	00

OFICINAS

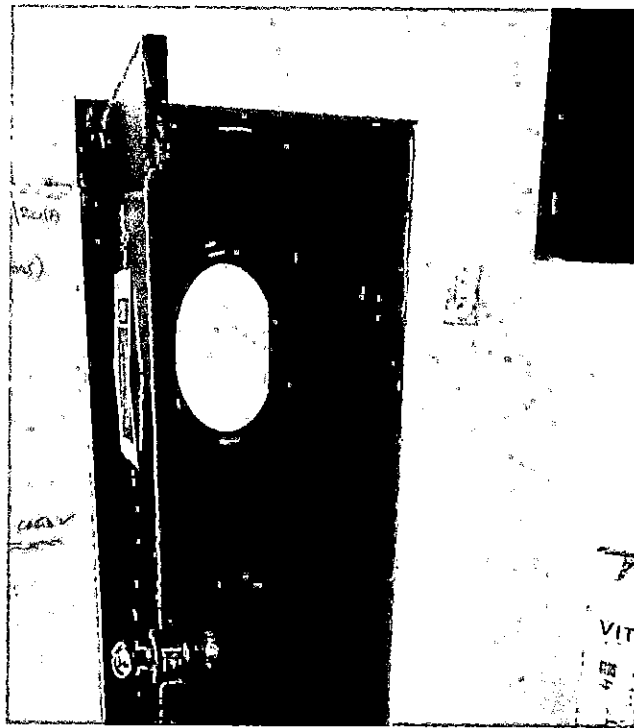

SSHH DE OFICINAS

5.2. EXTINTORES Y BOTIQUINES:

Este mes se realizó las inspecciones a los extintores Y botiquines de la obra, de acuerdo al programa de Seguridad y Salud en el Trabajo.

CONSORCIO MARÍTIMO DEL NORTE
 DESEMBARCADERO ARTESANAL DE SUPE
 Franklin Alfonso Mejía Acosta
 ING. SEG. Y MEDIO AMBIENTE
 CIP. 45497

CONSORCIO MARÍTIMO DEL NORTE
 DESEMBARCADERO ARTESANAL DE SUPE
 DANIEL JOAQUÍN TORALES VIVARICO
 RESIDENTE DE OBRA
 REG. CIP N° 98098

000097



CONSORCIO MARÍTIMO DEL NORTE

INFORME DE SSOMA

Tipo de Documento	Mes	Fecha	Revisión
Informe	Febrero	28/02/2019	00



EXTINTOR Y BOTIQUIN EN OFICINA

CONSORCIO MARÍTIMO DEL NORTE
DESEMBARCADERO ARTESANAL DE SUPE
Franklin Alfonso Mejía Acosta
ING. S.G. Y MEDIO AMBIENTE
CIP. 45497

CONSORCIO MARÍTIMO DEL NORTE
DESEMBARCADERO ARTESANAL DE SUPE
Daniel Joaquín Morales Vivero
DANIEL JOAQUÍN MORALES VIVERO
RESIDENTE DE OBRA
REG. CIP N° 98098

000096

 CONSORCIO MARÍTIMO DEL NORTE	CONSORCIO MARÍTIMO DEL NORTE		
	INFORME DE SSOMA		
	Tipo de Documento	Mes	Fecha
Informe	Febrero	28/02/2019	00

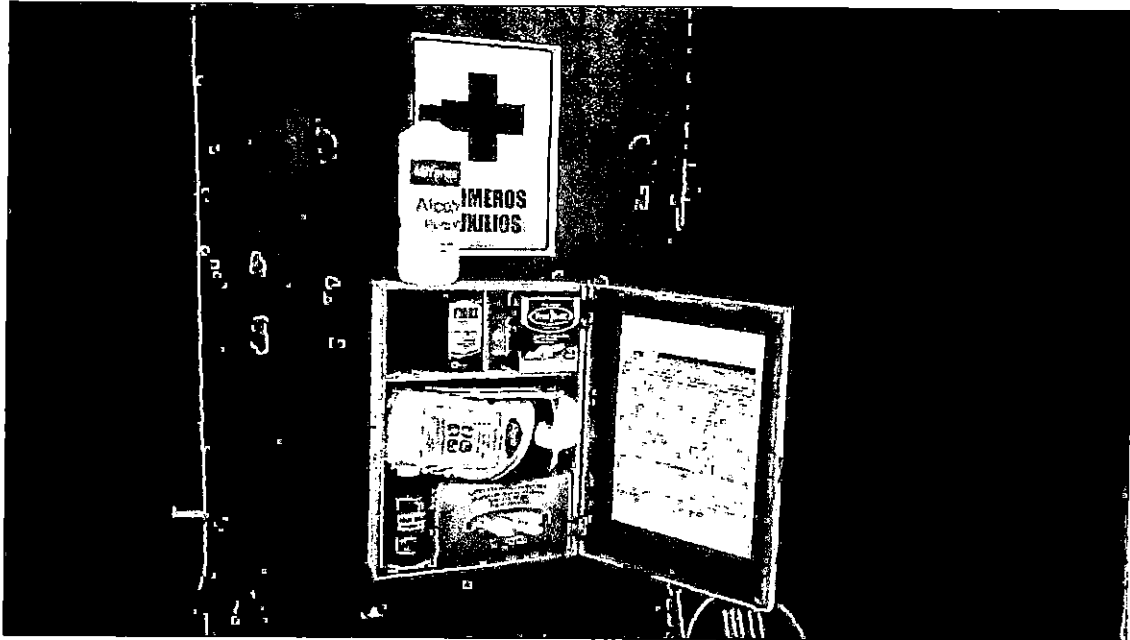

BOTIQUIN EN OBRA



EXTINTOR EN OBRA

CONSORCIO MARÍTIMO DEL NORTE
DESEMBARCADERO ARTESANAL DE SUPE

Franklin Alfonso Mejía Acosta
ING. S.G. Y MEDIO AMBIENTE
CIP. 45497

CONSORCIO MARÍTIMO DEL NORTE
DESEMBARCADERO ARTESANAL DE SUPE

Daniel Joaquín Morales Viva VCO
RESIDENTE DE OBRA
REC. CIP N° 93098

000095

 <p>CONSORCIO MARÍTIMO DEL NORTE</p>	CONSORCIO MARÍTIMO DEL NORTE			
	INFORME DE SSOMA			
	Tipo de Documento	Mes	Fecha	Revisión
Informe	Febrero	28/02/2019	00	

5.3. AREA OPERATIVA - OBRA:

Este mes se realizó las inspecciones al área operativa – obra.

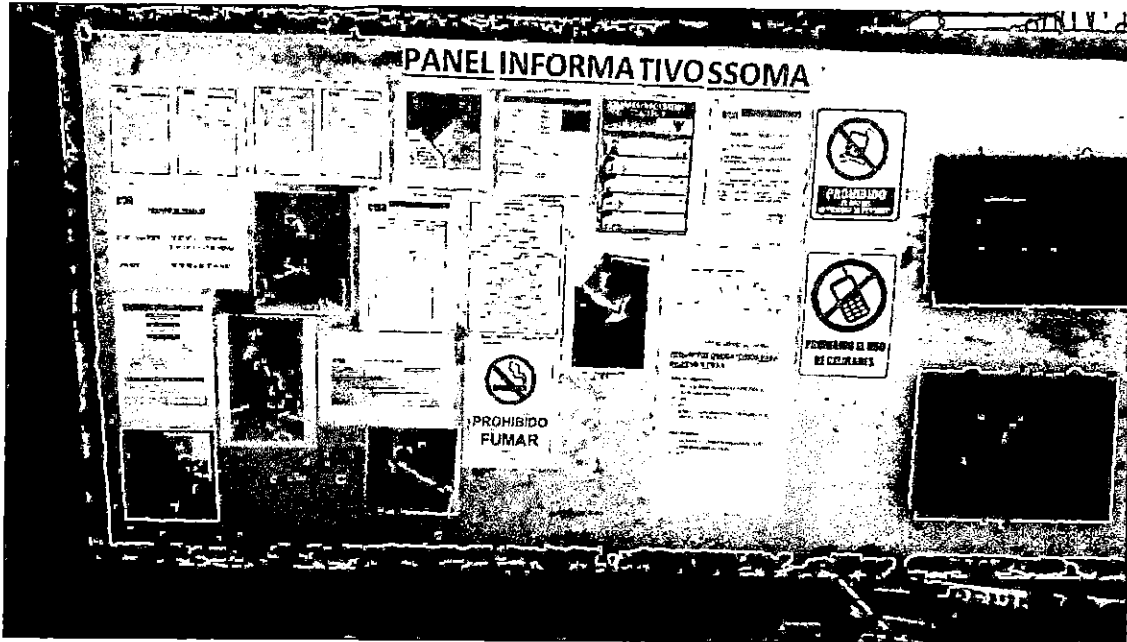

PANEL INFORMATIVO SECTOR A1



CONTENEDORES TEMPORALES DE RESIDUOS

CONSORCIO MARÍTIMO DEL NORTE
DESEMBARCADERO ARTESANAL DE SUPE

Franklin Alfonso Mejía Acosta
ING. SEG. Y MEDIO AMBIENTE
CIP. 45497

CONSORCIO MARÍTIMO DEL NORTE
DESEMBARCADERO ARTESANAL DE SUPE

Daniel J. ...
DANIEL JOSE ...
RESIDENTE DE OBRA
REG. C.P. N° 95392

000094



CONSORCIO MARÍTIMO DEL NORTE

CONSORCIO MARÍTIMO DEL NORTE

INFORME DE SSOMA

Tipo de Documento	Mes	Fecha	Revisión
Informe	Febrero	28/02/2019	00

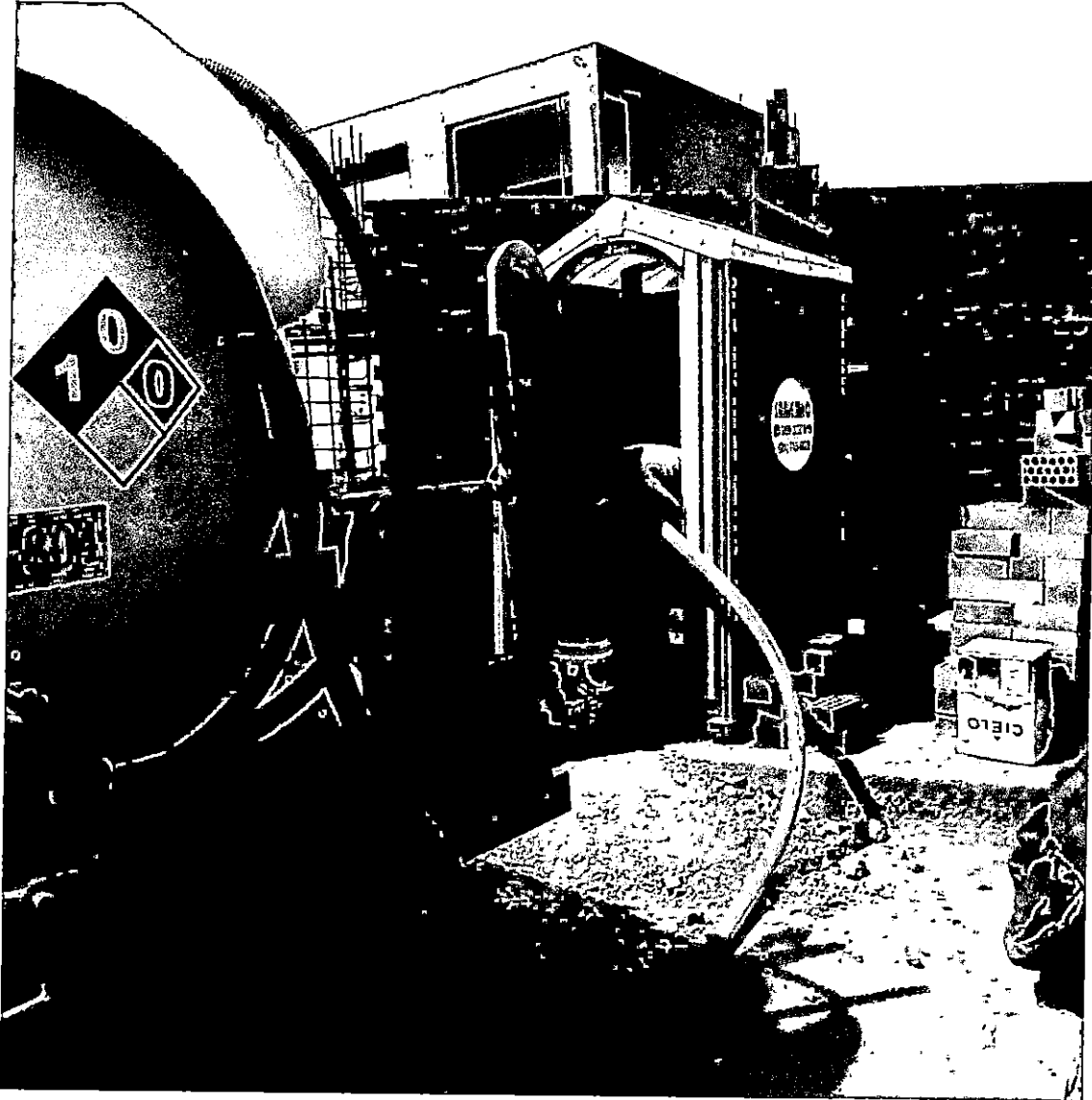

BAÑOS PORTATILES EN CAMPO

CONSORCIO MARÍTIMO DEL NORTE
DESEMBARCADERO ARTESANAL DE SUPE

Franklin Alfonso Mejía Acosta
ING. SEG. Y MEDIO AMBIENTE
CIP. 45497

CONSORCIO MARÍTIMO DEL NORTE
DESEMBARCADERO ARTESANAL DE SUPE

Daniel Joaquín Morales Vivero
RESIDENTE DE OBRA
REG. CIP. N° 98098



CONSORCIO MARÍTIMO DEL NORTE

INFORME DE SSOMA

Tipo de Documento	Mes	Fecha	Revisión
Informe	Febrero	28/02/2019	00



RIEGO CONSTANTE PARA EVITAR LA POLUCION

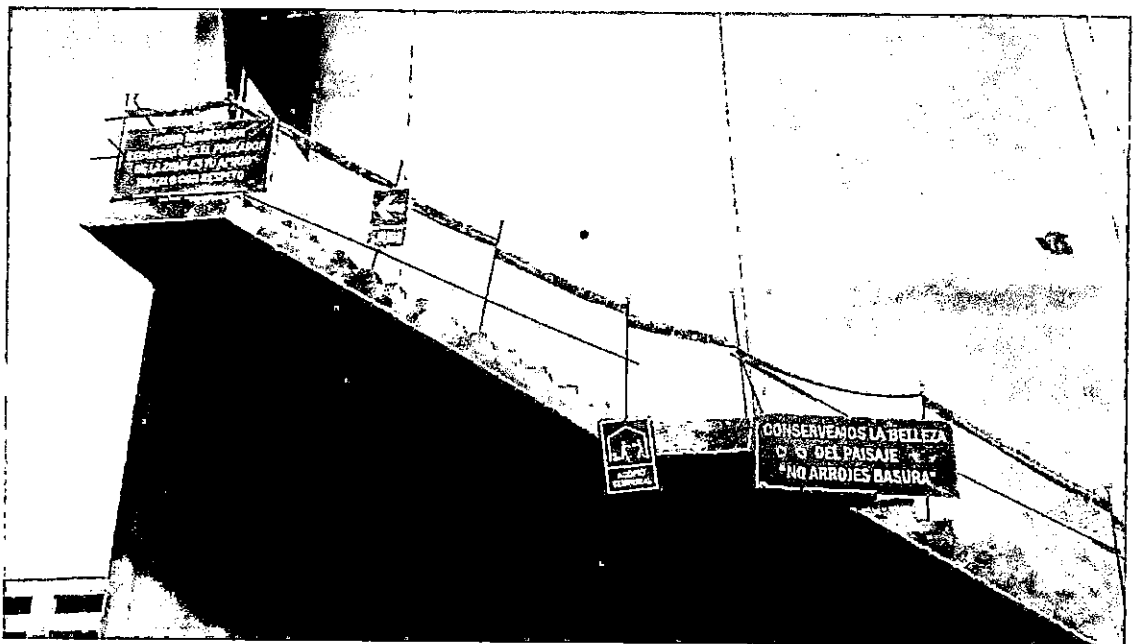

CUIDANDO LA BELLEZA DEL PAISAJE

CONSORCIO MARÍTIMO DEL NORTE
DESEMBARCADERO ARTESANAL DE SUPE

Franklin Alfonso Mejía Acosta
ING. SEG. Y MEDIO AMBIENTE
CIP. 45497

CONSORCIO MARÍTIMO DEL NORTE
DESEMBARCADERO ARTESANAL DE SUPE

DAE EL JOAQUÍN MORALES VIVAS
RESIDENTE DE OBRA
REG. CIP N° 98098

000092

	CONSORCIO MARÍTIMO DEL NORTE			
	INFORME DE SSOMA			
	Tipo de Documento	Mes	Fecha	Revisión
Informe	Febrero	28/02/2019	00	



CUIDEMOS EL MEDIO AMBIENTE

CONSORCIO MARITIMO DEL NORTE
DESEMBARCADERO ARTESANAL DE SUPE
Franklin Alfonso Mejía Acosta
ING. SEG. Y MEDIO AMBIENTE
CIP. 45497

CONSORCIO MARITIMO DEL NORTE
DESEMBARCADERO ARTESANAL DE SUPE
DANIEL JOAQUIN MORALES VIVI 'C'
RESIDENTE DE OBRA
REG. CIP N° 96098

000091



CONSORCIO MARÍTIMO DEL NORTE

CONSORCIO MARÍTIMO DEL NORTE

INFORME DE SSOMA

Tipo de Documento	Mes	Fecha	Revisión
Informe	Febrero	28/02/2019	00

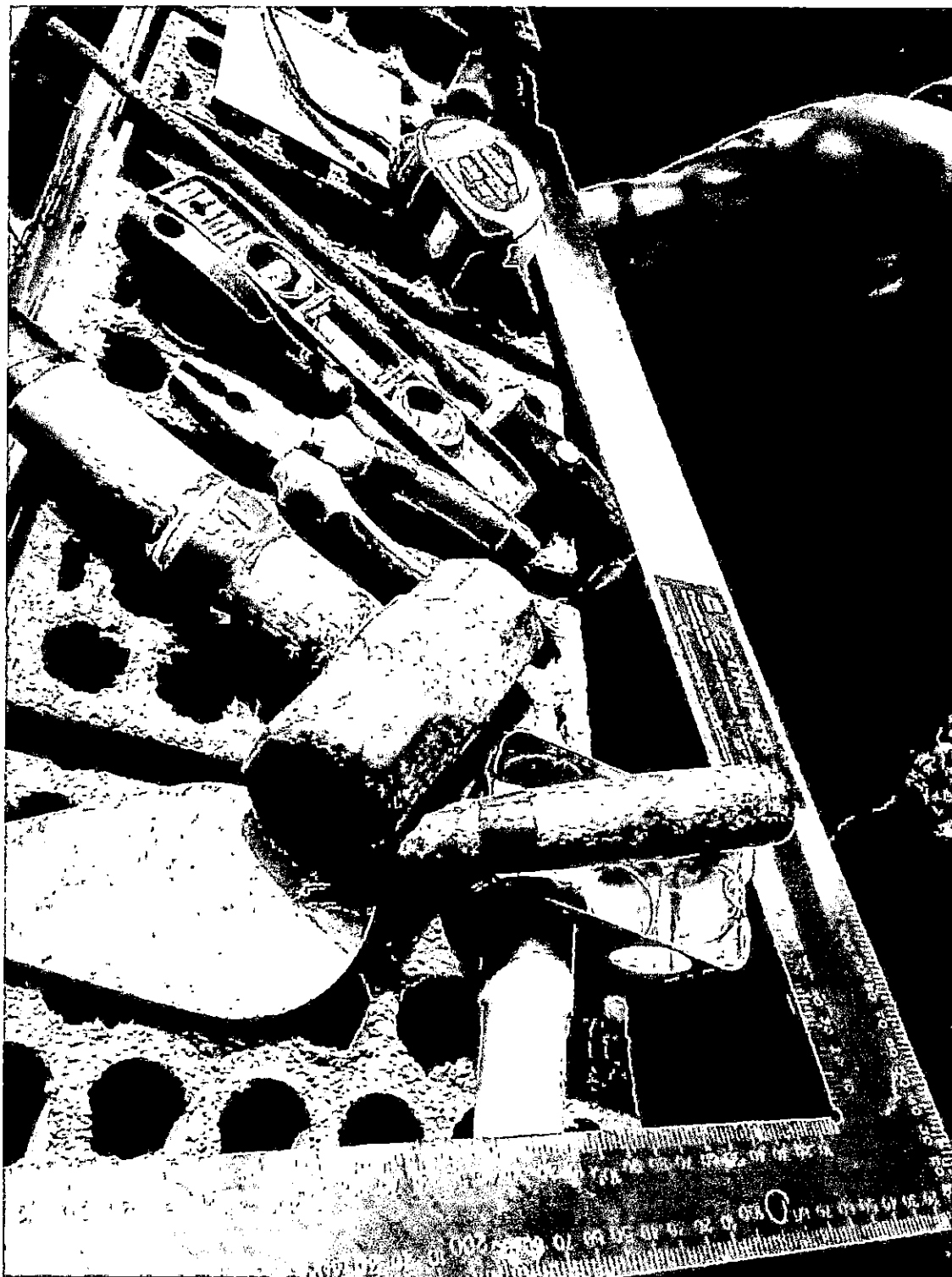

CINTA DEL MES A HERRAMIENTAS

CONSORCIO MARÍTIMO DEL NORTE
DESEMBARCADERO ARTESANAL DE SUPE

Franklin Alfonso Mejía Acosta
ING. SEG. Y MEDIO AMBIENTE
CIP. 45497

CONSORCIO MARÍTIMO DEL NORTE
DESEMBARCADERO ARTESANAL DE SUPE

DANIEL JOAQUÍN MORALES VIVANCO
RESIDENTE DE OBRA
REG. CIP N° 98098

 CMN CONSORCIO MARÍTIMO DEL NORTE	CONSORCIO MARÍTIMO DEL NORTE			
	INFORME DE SSOMA			
	Tipo de Documento	Mes	Fecha	Revisión
Informe	Febrero	28/02/2019	00	

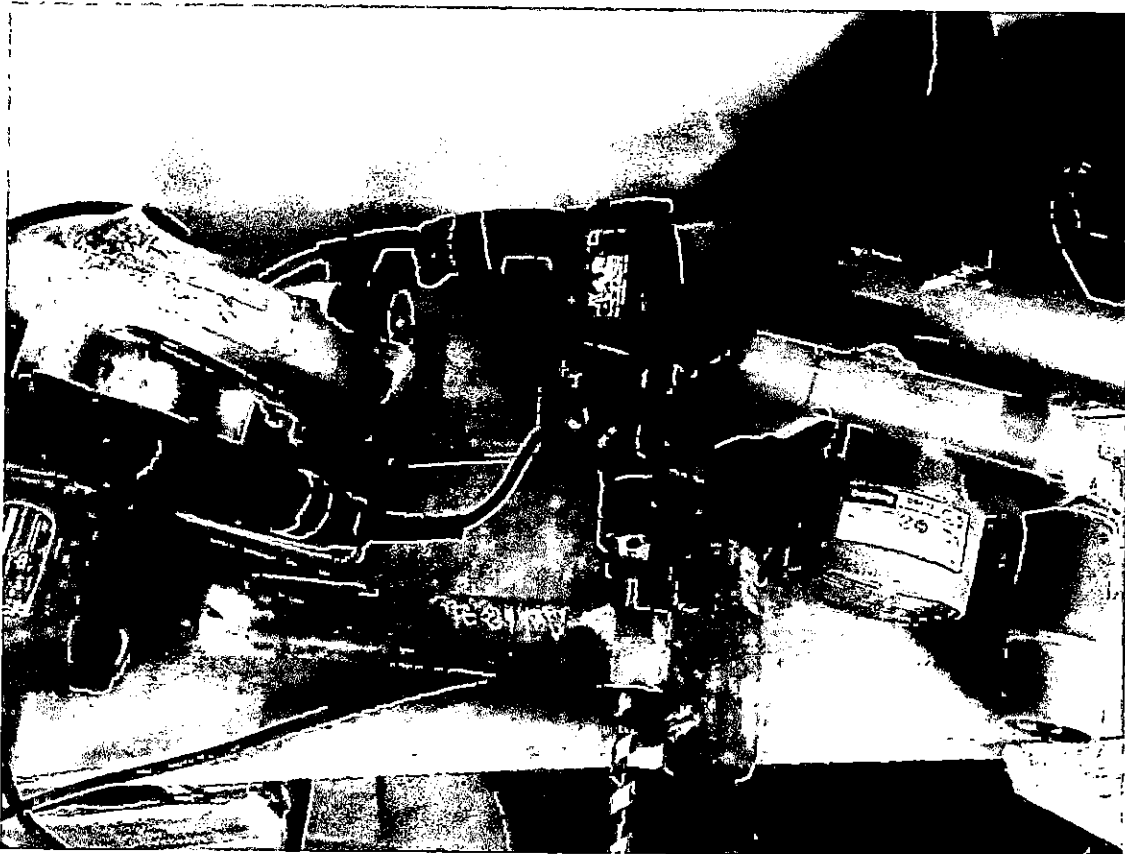

CINTA DEL MES EN EQUIPOS MENORES

CONSORCIO MARÍTIMO DEL NORTE
 DESEMBARCADERO ARTESANAL DE SUPE

Franklin Alonso Mejía Acosta
 ING. SEG. Y MEDIO AMBIENTE
 CIP. 45497

CONSORCIO MARÍTIMO DEL NORTE
 DESEMBARCADERO ARTESANAL DE SUPE

Daniel Joaquín Morales Viva y Co
 RESIDENTE DE OBRA
 REG. CIP N° 98058

000089



CONSORCIO MARITIMO DEL NORTE

ANEXOS

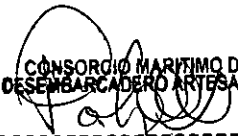
CONSORCIO MARITIMO DEL NORTE
DESEMBARCADERO ARTESANAL DE SUPE

DANIEL JOAQUIN MORALES VIVA NCO
RESIDENTE DE OBRA
REG. CIP N° 98096

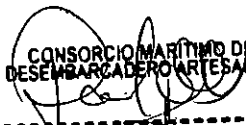

CONSORCIO MARITIMO DEL NORTE

ANEXO N° 1

CONSORCIO MARITIMO DEL NORTE
DESEMBARCADEPOARTESANAL DE SUPE

DANIEL JOAQUIN MORALES VIVA NCC
RESIDENTE DE OBRA
REG. CIP N° 98098



INDICE ANEXO 1
HORAS HOMBRE TRABAJADAS
CAPACITACIONES
ESTADISTICAS
REPORTE DE INCIDENTES
RESUMEN DE GESTION
CONCLUSIONES
PERSONAL DEBRERO - HH - HM
MATRIZ DE CHECK LIST FEBRERO
ACUMULADO ESTADISTICO TOTAL DE OBRA

CONSORCIO MARITIMO DEL NORTE
DESEMBARCADERO ARTESANAL DE SUPE

Franklin Alonso Mejía Acosta
ING. SEG. Y MEDIO AMBIENTE
CIP. 45497

CONSORCIO MARITIMO DEL NORTE
DESEMBARCADERO ARTESANAL DE SUPE

Daniel Joaquín Morales Viva
DANIEL JOAQUÍN MORALES VIVA
RESIDENTE DE OBRA
REC. C.P. N° 50008

ING. SEG. Y MEDIO AMBIENTE
CIP. 45497

RESIDENTE DE OBRA
REC. C.P. N° 50008

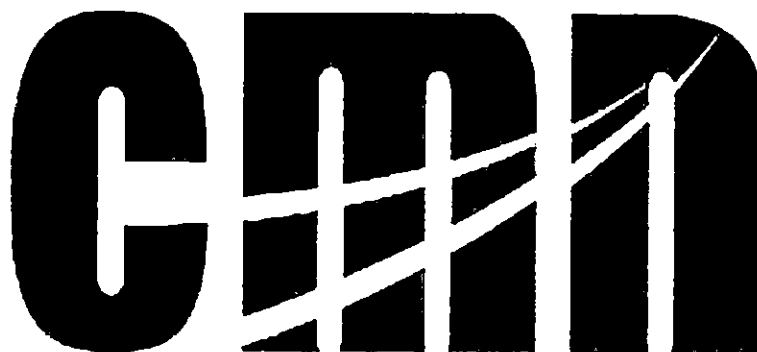

CONSORCIO MARITIMO DEL NORTE

ANEXO N° 2

CONSORCIO MARITIMO DEL NORTE
DESEMBARCADERO ARTESANAL DE SUPE



DANIEL JOAQUIN MORALES VIVA NCL
RESIDENTE DE OBRA
REG. CIP N° 98098

000079

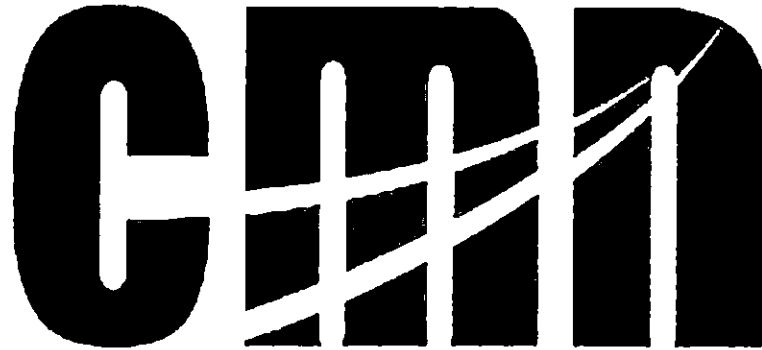

CONSORCIO MARITIMO DEL NORTE

01. EMO'S

CONSORCIO MARITIMO DEL NORTE
DESEMBARCADERO ARTESANAL DE SUPE
DANIEL JOAQUIN MORALES VIVA VCL
RESIDENTE DE OBRA
REG. CIP N° 96096

000078



**CERTIFICADO DE APTITUD
MEDICO OCUPACIONAL**

72715465
Nro. Registro: 0
01/02/2019

Datos Personales:

Tipo de Atención: **PRE- OCUPACIONAL**

Apellidos y Nombres: **RAMIREZ CUEVA CARLOS DANIEL**
Documento de Identidad: **72715465** Edad: **20** años Sexo: **MASCULINO**
Fecha del examen: **01/02/2019** Fecha de Caducidad: **01/02/2020**

Razón Social Empresa: **CONSTRUCCIONES CMD S.A.C.**

Empresa Sub-Contratista:

Puesto al que postula (Solo pre- ocupacional): **OPERARIO**

Ocupación actual o última ocupación:

Historia Clínica: **72715465**

APTITUD

APTO (Para puesto en el que trabaja o postula)	X	RESTRICCIONES
APTO CON RESTRICCIONES (Para puesto en el que trabaja o postula)		
NO APTO (Para puesto en el que trabaja o postula)		
OBSERVADO		

Julio Enrique Valentin Ramirez
MEDICO OCUPACIONAL
C.M.P. 62397
RNA: A04608

Sello y Firma de Medico que CERTIFICA

CARLOS REMY PAREDES
MÉDICO - CIPIJANO
C.M.P. 53290

Sello y Firma de Médico que CERTIFICA

000077

**CERTIFICADO DE APTITUD
MEDICO OCUPACIONAL**

42635420

Nro. Registro: 0

31/01/2019

Datos Personales:Tipo de Atención: **PRE- OCUPACIONAL**Apellidos y Nombres: **ORTIZ CHAHUA JUAN CARLOS**Documento de Identidad: **42635420**Edad: **35 años**Sexo: **MASCULINO**Fecha del examen: **31/01/2019**

Fecha de Caducidad:

31/01/2020Razón Social Empresa: **CONSTRUCCIONES CMD S.A.C.**

Empresa Sub-Contratista:

Puesto al que postula (Solo pre- ocupacional): **OPERARIO**

Ocupación actual o última ocupación:

Historia Clínica: **42635420****APTITUD****APTO**

(Para puesto en el que trabaja o postula)

X**RESTRICCIONES****APTO CON RESTRICCIONES**

(Para puesto en el que trabaja o postula)

NO APTO

(Para puesto en el que trabaja o postula)

OBSERVADO
Julio Enrique Valentin Ramirez
MEDICO OCUPACIONAL
Cardeni C.M.P 62397
RNA: A04608

Sello y Firma de Médico que CERTIFICA

CARLOS REMY PAREDES
MÉDICO - CIRUJANO
CMP 52290

Sello y Firma de Médico que CERTIFICA

000076

**CERTIFICADO DE APTITUD
MEDICO OCUPACIONAL**

15665419

Nro. Registro: 0

24/01/2019

Datos Personales:Tipo de Atención: **PRE- OCUPACIONAL**Apellidos y Nombres: **FLORES CARO JUAN MARIANO**Documento de Identidad: **15665419**Edad: **66 años**Sexo: **MASCULINO**Fecha del examen: **24/01/2019**

Fecha de Caducidad:

24/01/2020Agrupación Social Empresa: **CONSTRUCCIONES CMD S.A.C.**

Empresa Sub-Contratista:

Puesto al que postula (Solo pre- ocupacional): **OPERARIO**

Ocupación actual o última ocupación:

Historia Clínica: **15665419****APTITUD**

APTO		RESTRICCIONES
(Para puesto en el que trabaja o postula)		
APTO CON RESTRICCIONES	X	-USO DE PROTECCION AUDITIVA EN ZONAS EXPUESTAS A RUIDO MAYOR A 85 dB.
(Para puesto en el que trabaja o postula)		
NO APTO		
(Para puesto en el que trabaja o postula)		
OBSERVADO		

Julio Enrique Valentin Ramirez
MEDICO OCUPACIONAL
Cardeni CMP 62397
RNA: A01408
Sello y Firma de Médico que CERTIFICA
CARLOS REMY PAREDES
MÉDICO - CIRUJANO
CMP 53299
Sello y Firma de Médico que CERTIFICA

000075

**CERTIFICADO DE APTITUD
MEDICO OCUPACIONAL**

72240042

Nro. Registro: 0

04/02/2019

Datos Personales:Tipo de Atención: **PRE- OCUPACIONAL**Apellidos y Nombres: **BENITO DE LA CRUZ YERSON YAK**Documento de Identidad: **72240042**Edad: **23 años**Sexo: **MASCULINO**Fecha del examen: **04/02/2019**

Fecha de Caducidad:

04/02/2020Aseguradora Social Empresa: **CONSTRUCCIONES CMD S.A.C.**

Empresa Sub-Contratista:

Puesto al que postula (Solo pre- ocupacional): **OPERARIO**

Ocupación actual o última ocupación:

Historia Clínica: **72240042****APTITUD****APTO**

(Para puesto en el que trabaja o postula)

RESTRICCIONES**APTO CON RESTRICCIONES**

(Para puesto en el que trabaja o postula)

X**-USO PERMANENTE DE CORRECTORES OCULARES.****NO APTO**

(Para puesto en el que trabaja o postula)

OBSERVADO
Julio Enrique Valentin Ramirez
MEDICO OCUPACIONAL
Cardeni C.M.P. 62397
RINA: A04209

Sello y Firma de Médico que CERTIFICA

CARLOS REMY PAREDES
MÉDICO - CIRUJANO
CMP 53290

Sello y Firma de Médico que CERTIFICA

000074

**CERTIFICADO DE APTITUD
MEDICO OCUPACIONAL**

9020237

Nro. Registro: 0

01/02/2019

Datos Personales:Tipo de Atención: **PRE- OCUPACIONAL**Apellidos y Nombres: **ZEÑA SANTA MARIA MANUEL**Documento de Identidad: **9020237**Edad: **56 años**Sexo: **MASCULINO**Fecha del examen: **01/02/2019**

Fecha de Caducidad:

01/02/2020Razón Social Empresa: **CONSTRUCCIONES CMD S.A.C.**

Empresa Sub-Contratista:

Puesto al que postula (Solo pre- ocupacional): **OPERARIO**

Ocupación actual o última ocupación:

Historia Clínica: **9020237****APTITUD**

APTO		RESTRICCIONES
(Para puesto en el que trabaja o postula)		
APTO CON RESTRICCIONES	X	-USO ESTRICTO DE PROTECCION AUDITIVA EN ZONAS EXPUESTAS A RUIDI MAYOR A 85 Db.
(Para puesto en el que trabaja o postula)		
NO APTO		
(Para puesto en el que trabaja o postula)		
OBSERVADO		

Julio Enrique Valentín Ramirez
 MEDICO OCUPACIONAL

Cardeni C.M.P. 62397
 RINA: A04408

Sello y Firma de Médico que CERTIFICA

CARLOS REMY PARDEES
 MEDICO OCUPACIONAL
 C.M.P. 52290

Sello y Firma de Médico que CERTIFICA

005573



CONSORCIO MARITIMO DEL NORTE

02. SCTR

CONSORCIO MARITIMO DEL NORTE
DESEMBARCADERO ARTESANAL DE SUPE

DANIEL JOAQUIN MORALES VIVANCO
RESIDENTE DE OBRA
REG. CIP N° 98098

San Isidro, 20 de Febrero del 2019

CONSTANCIA N° 3123131

Señores
CONSORCIO MARITIMO DEL NORTE
Presente.-

Ref.: **SEGURO COMPLEMENTARIO DE TRABAJO DE RIESGO – SALUD Y PENSION**

Estimados Señores:

Por medio del presente dejamos constancia que su representada ha incluido la cobertura del Seguro Complementario de Trabajo de Riesgo para el periodo 01 de Febrero del 2019 al 28 de Febrero del 2019 correspondiente a:

CONTRATO N° **83448** en SALUD y,
POLIZA N° **62057462** en PENSION

para la siguiente relación de trabajadores declarados por vuestra empresa.

Proyecto/Obra:

N°	APELLIDOS Y NOMBRES	NRO. DOCUMENTO	INICIO DE COBERTURA
000001	CAMARA ALVA MAXIMO PETER	40301597	01 de Febrero del 2019
000002	CHUNGA SUCLUPE JOSE CRUZ	76753419	01 de Febrero del 2019
000003	FLORES FERNANDEZ OMAR	43391245	01 de Febrero del 2019

Sin otro particular , quedamos de ustedes

Atentamente,

CARLOS SILES
GERENTE

ANGEL ARMIÑO HIDALGO
GERENTE

000071

Pacífico EPS

Pacífico Seguros

San Isidro, 12 de Febrero del 2019

CONSTANCIA N° 3118636

Señores
CONSORCIO MARITIMO DEL NORTE
Presente.-

Ref.: **SEGURO COMPLEMENTARIO DE TRABAJO DE RIESGO – SALUD Y PENSION**

Estimados Señores:

Por medio del presente dejamos constancia que su representada ha incluido la cobertura del Seguro Complementario de Trabajo de Riesgo para el periodo 01 de Febrero del 2019 al 28 de Febrero del 2019 correspondiente a:

CONTRATO N° **83448** en SALUD y,
POLIZA N° **62057462** en PENSION

para la siguiente relación de trabajadores declarados por vuestra empresa.

Proyecto/Obra:

N°	APELLIDOS Y NOMBRES	NRO. DOCUMENTO	INICIO DE COBERTURA
000001	ARICOCHE CHAPOÑAN JOSE LUIS	07481784	01 de Febrero del 2019
000002	MANOSALVA URIARTE JENER IVAN	40983427	01 de Febrero del 2019
000003	PRINCIPE SUAREZ HERNAN	80343047	01 de Febrero del 2019
000004	RODRIGUEZ CHIQUES JULIO	42500016	01 de Febrero del 2019

Sin otro particular , quedamos de ustedes

Atentamente,

CARLOS SILES
GERENTE

ÁNGEL ARMIÑO HIDALGO
GERENTE

000070

Pacífico EPS**Pacífico Seguros**

San Isidro, 31 de Enero del 2019

CONSTANCIA N° 3106489

Señores
CONSORCIO MARITIMO DEL NORTE
 Presente.-

Ref.: **SEGURO COMPLEMENTARIO DE TRABAJO DE RIESGO – SALUD Y PENSION**

Estimados Señores:

Por medio del presente dejamos constancia que su representada ha incluido la cobertura del Seguro Complementario de Trabajo de Riesgo para el periodo 01 de Febrero del 2019 al 28 de Febrero del 2019 correspondiente a:

CONTRATO N° **83448** en SALUD y,
POLIZA N° **62057462** en PENSION

para la siguiente relación de trabajadores declarados por vuestra empresa.

Proyecto/Obra:

N°	APELLIDOS Y NOMBRES	NRO. DOCUMENTO	INICIO DE COBERTURA
000001	ACOSTA DE LA CRUZ EFRAIN	32904567	01 de Febrero del 2019
000002	AGURTO SAAVEDRA SINAHY	42797670	01 de Febrero del 2019
000003	AMAYA VILLENA HENRY RAMON	33264710	01 de Febrero del 2019
000004	AQUINO VILCA JULIO VIDAL	41756501	01 de Febrero del 2019
000005	BARRETO MAURICIO RONALD JESUS	71263697	01 de Febrero del 2019
000006	BERECHE GONZALES NILL ERICXON	49986508	01 de Febrero del 2019
000007	CABANILLAS LLANOS VICTIR	15853293	01 de Febrero del 2019
000008	CABELLO BRAVO SAMUEL CIRO	32730189	01 de Febrero del 2019
000009	CELESTINO DURAN FRANK DAVID	77025343	01 de Febrero del 2019
000010	CHURA CUTIPA SIPRIANO VICTOR	00491322	01 de Febrero del 2019
000011	CISNEROS BALLONA MAXINO ALNIBAR	25799043	01 de Febrero del 2019
000012	CISNEROS HERRERA LIONEL HERNAN	43342826	01 de Febrero del 2019
000013	CORTHON FERNANDEZ OSCAR EDUARDO	41576200	01 de Febrero del 2019
000014	CRUZ BAZAN GILBERTO ELEAZAR	42509324	01 de Febrero del 2019
000015	DELGADO CUEVA CRISTIAN WILFREDO	80283814	01 de Febrero del 2019
000016	ESCALANTE PEREZ CHRISTOPHER JOSE	46075491	01 de Febrero del 2019
000017	FASABI SHUPINGAHUA PAUL	75834892	01 de Febrero del 2019

Pacífico EPS

Pacífico Seguros

000018	GALINDO VEGA BRAYAN MICHAEL	72422711	01 de Febrero del 2019
000019	GARCIA CASIMIRO GUIDO	06857676	01 de Febrero del 2019
000020	GENEBROSO FLORES FIDEL ANGEL	40006826	01 de Febrero del 2019
000021	GONZALES CARHUAJULCA LUIS CARLOS	43978979	01 de Febrero del 2019
000022	GONZALES MACHACCA JOVENIL	48288638	01 de Febrero del 2019
000023	GONZALES REYES YONFER FELIX	48084141	01 de Febrero del 2019
000024	GUADALUPE SANCHEZ BUENAVENTURA	09000045	01 de Febrero del 2019
000025	GUTIERREZ MONTES ALEJANDRO	44777987	01 de Febrero del 2019
000026	HUAMAN POMA HERMINIO	20032409	01 de Febrero del 2019
000027	HUAMAN SOTOMAYOR GREGORIO	40016313	01 de Febrero del 2019
000028	ICHPAS HERRERA ARMANDO HERNAN	47700282	01 de Febrero del 2019
000029	LOPEZ AGURTO PEDRO GABRIEL	09968114	01 de Febrero del 2019
000030	MEJIA ACOSTA FRANKLIN ALFONSO	32762157	01 de Febrero del 2019
000031	MENDEZ CHIMBORAZO JOSE GERMAN	001669624	01 de Febrero del 2019
000032	MOGOLLON ALBURQUEQUE CARLOS HECTC	03874802	01 de Febrero del 2019
000033	MORALES CURI HAROLD ENDREY	70913009	01 de Febrero del 2019
000034	MORALES PISCOYA PEDRO	17555912	01 de Febrero del 2019
000035	MORALES VIVANCO DANIEL JOAQUIN	25595900	01 de Febrero del 2019
000036	NAVARRO CARREÑO WILLIAM ORLANDO	03660751	01 de Febrero del 2019
000037	NOBERTO TITO JOSE LUIS	41775751	01 de Febrero del 2019
000038	OBREGON TREJO CRISTHIAN RONALD	72535185	01 de Febrero del 2019
000039	ORTECHO CLAVO CHRISTIAN BORIS	46407431	01 de Febrero del 2019
000040	PERALES ZEVALLOS NOE MAXIMO	44505979	01 de Febrero del 2019
000041	RAMIREZ CAMPOS NELSON MICHAEL	45538474	01 de Febrero del 2019
000042	RIVERA SANCHEZ CARLOS ARCADIO	46538463	01 de Febrero del 2019
000043	RIVERA SOTOMAYOR LUCIANO	10064683	01 de Febrero del 2019
000044	RODRIGUEZ CHUMBES ANGEL ARTURO	41942549	01 de Febrero del 2019
000045	SAAVEDRA CORTEZ RHOLY JOHNSTONE	42139151	01 de Febrero del 2019
000046	SALAS AMACIFUEN REITER	40915271	01 de Febrero del 2019
000047	SANCHEZ LOPEZ LUIS MIGUEL	44855504	01 de Febrero del 2019
000048	SANTILLAN QUIROZ JULIO	18845643	01 de Febrero del 2019
000049	SOTO JARA ELVIS KLEINER	15447991	01 de Febrero del 2019
000050	SOTO JARA JORGE LUIS	45528371	01 de Febrero del 2019
000051	TACO GUILLEN DONATO	43557372	01 de Febrero del 2019
000052	TRUJILLO AVALOS HENRRY	47626241	01 de Febrero del 2019

000068

Pacífico EPS**Pacífico Seguros**

000053	UGARTE VASQUEZ GUILLERMO MANUEL	47345541	01 de Febrero del 2019
000054	VALVERDE OSORIO OBSTAQUIO AGAPE	32763872	01 de Febrero del 2019
000055	VEGA ZORRILLA WILLIAM KING	40181821	01 de Febrero del 2019
000056	VERA CASTAÑEDA LUIS	42517924	01 de Febrero del 2019

Sin otro particular , quedamos de ustedes

Atentamente,

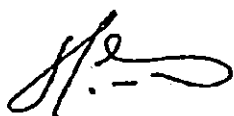

CARLOS SILES
GERENTE



ANGEL ARMIJO HIDALGO
GERENTE

000067

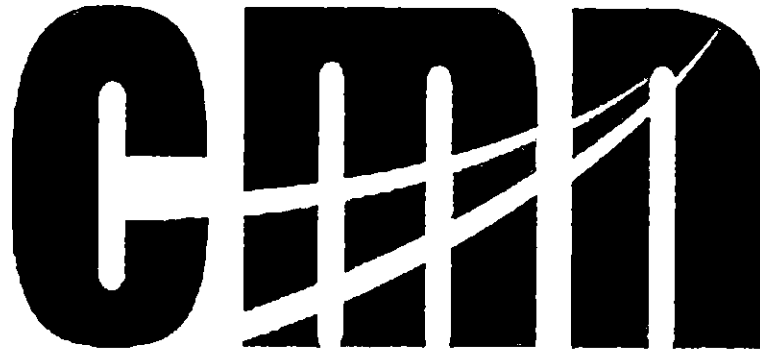

CONSORCIO MARITIMO DEL NORTE

03. INDUCCION

CONSORCIO MARITIMO DEL NORTE
DESEMBARCADERO ARTESANAL DE SUPE

[Handwritten Signature]

DANIEL JOAQUIN MORALES VIVA NCO
RESIDENTE DE OBRA
REG. CIP N° 98098



SISTEMA DE GESTIÓN DE SEGURIDAD Y SALUD EN EL TRABAJO

CONTROL DE ASISTENCIA

Código SSOMA FT-42
Revisión 00
Fecha 01/02/2019
Página 11 000066

OBRA: Mejoramiento y Recuperación de los Servicios del DPA Supe

N° REGISTRO:

DATOS DEL EMPLEADOR

RAZÓN SOCIAL O DENOMINACIÓN SOCIAL	RUC	DOMICILIO (Dirección, distrito, departamento, provincia)	ACTIVIDAD ECONÓMICA	IP DE TRABAJADORES DEL STAFF
Consorcio Merlimo del Norte	20602379000	Calle Vizcaya 167 San Luis - Lima	Construcción	

TIPO DE EVENTO (MARCAR CON X)

INDUCCIÓN SIMULACRO DE EMERGENCIA CAPACITACIÓN

ENTRENAMIENTO CHARLA DE INICIO DE JORNADA OTROS

TEMAS TRATADOS

INDUCCION TRABAJADOR NUEVO

FECHA 01/02/2019 NUMERO DE CONVOCADOS 8

HORA DE INICIO 3:00 PM NUMERO DE PARTICIPANTES 8

TIEMPO DE DURACIÓN 2 HORAS NOMBRE DEL EXPOSITOR F. MEJIA

FIRMA DEL EXPOSITOR *[Signature]*

NRO.	APELLIDOS Y NOMBRE DE LOS PARTICIPANTES	DNI	AREA	EMPRESA	FIRMA	OBSERVACIONES
1	HIDALGO BENIA	09020237	PINTOR	CMN	<i>[Signature]</i>	PINTOR
2	Juan Carlos Ortiz Challo	42635420	ayudante	CMN	<i>[Signature]</i>	
3	Ramirez Corales Omar	70349324	PINTURA	CMN	<i>[Signature]</i>	
4	DAMAZO ZUÑEVA DANIEL	72775065	PINTURA	C.M.N	<i>[Signature]</i>	
5	Florez CABO JUAN	15225419	PINTOR	CMN	<i>[Signature]</i>	
6	Hernandez Alvarez Juan	42376272	Ayudante	CMN	<i>[Signature]</i>	
7	Eslava Cortez Juan	86461851	PINTOR	CMN	<i>[Signature]</i>	
8	MANUEL VILLA PANTA	25542975	PINTOR	COMA	<i>[Signature]</i>	
9						
10						
11						
12						
13						
14						
15						
16						
17						
18						
19						
20						

RESPONSABLE DEL REGISTRO

Nombre: FRANKLIN A. MEJIA ACOSTA

Cargo: ING. SSOMA

Fecha: 01/02/2019

Firma: *[Signature]*



SISTEMA DE GESTIÓN DE SEGURIDAD Y SALUD EN EL TRABAJO

Código: SSOMA-FI-42

Revisión: 00

Fecha: 21/03/2017

Pag: 001065

CONTROL DE ASISTENCIA

OBRA: Mejoramiento y Recuperación de los Servicios del DPA Supe

N° REGISTRO: 3

DATOS DEL EMPLEADOR

RAZÓN SOCIAL O DENOMINACIÓN SOCIAL	RUC	DOMICILIO (Dirección, distrito, departamento, provincia)	ACTIVIDAD ECONÓMICA	N° DE TRABAJADORES DEL STAFF
Consortio Marítimo del Norte	20602379300	Calle Vizcaya 187 San Luis - Lima	Construcción	

TIPO DE EVENTO (MARCAR CON X)

INDUCCIÓN

SIMULACRO DE EMERGENCIA

CAPACITACIÓN

ENTRENAMIENTO

CHARLA DE PAQUETE DE JORNADA

OTROS

TEMAS TRATADOS

INDUCCION TRABAJADOR NUEVO

FECHA

06/02/2019

NUMERO DE CONVOCADOS

2

HORA DE INICIO

3:00 P.M.

NUMERO DE PARTICIPANTES

2

TIEMPO DE DURACIÓN

2 HORAS

NOMBRE DEL EXPOSITOR

F. MEJIA

FIRMA DEL EXPOSITOR

NRO.	APELLIDOS Y NOMBRE DE LOS PARTICIPANTES	DNI	AREA	EMPRESA	FIRMA	OBSERVACIONES
1	Benito de la Cruz Yerson	72240042	Pintura	CMN		
2	Moya Lopez Wilder	45177800	Pintura	CMN		
3						
4						
5						
6						
7						
8						
9						
10						
11						
12						
13						
14						
15						
16						
17						
18						
19						
20						

RESPONSABLE DEL REGISTRO

Nombre:

FRANKLIN A. MEJIA ACOSTA

Cargo:

ING. SSOMA

Fecha:

06/02/2019

Firma:



SISTEMA DE GESTIÓN DE SEGURIDAD Y SALUD EN EL TRABAJO

Código: SSOVA-FT-42
Revisión: 01
Fecha: 000067
Página: 1/1

CONTROL DE ASISTENCIA

OBRA: Mejoramiento y Recuperación de los Servicios del DPA Supe

N° REGISTRO:

DATOS DEL EMPLEADOR

RAZÓN SOCIAL O DENOMINACIÓN SOCIAL	RUC	DOMICILIO (Dirección, distrito, departamento, provincia)	ACTIVIDAD ECONÓMICA	N° DE TRABAJADORES
Consorcio Marítimo del Norte	20002379320	Calle Vizcaya 187 San Luis - Lima	Construcción	

TIPO DE EVENTO (MARCAR CON X)

INDUCCIÓN: SIMULACRO DE EMERGENCIA: CAPACITACIÓN:
 ENTRENAMIENTO: CHARLA DE INICIO DE JORNADA: OTROS:

TEMAS TRATADOS

INDUCCION HOMBAS NUEVO

FECHA: 16/02/2017 NUMERO DE CONVOCADOS: 2
 HORA DE INICIO: 8:00 AM NUMERO DE PARTICIPANTES: 2
 TIEMPO DE DURACIÓN: 2 HRS. NOMBRE DEL EXPOSITOR: F. MEJIA
 FIRMA DEL EXPOSITOR: *[Signature]*

NRO.	APELLIDOS Y NOMBRE DE LOS PARTICIPANTES	DNI	AREA	EMPRESA	FIRMA	OBSERVACIONES
1	ZAPATA PEREZ TEODORO	09578037	OP	CMN	<i>[Signature]</i>	
2	Elesban Zapata Perez	43095117	OP	CMN	<i>[Signature]</i>	
3						
4						
5						
6						
7						
8						
9						
10						
11						
12						
13						
14						
15						
16						
17						
18						
19						

RESPONSABLE DEL REGISTRO

Nombre: FRANKLIN A. MEJIA ACOSTA
 Cargo: ING. SSOMA
 Fecha: 16/02/2017
 Firma: *[Signature]*

000000



CONSORCIO MARITIMO DEL NORTE

**04. CHARLAS INICIO
JORNADA**

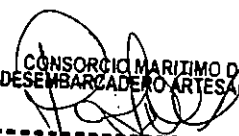
CONSORCIO MARITIMO DEL NORTE
DESEMBARCADERO ARTESANAL DE SUPE

DANIEL JOAQUÍN MORALES VIVA VCC
RESIDENTE DE OBRA
REG. CIP N° 98098

**SISTEMA DE GESTIÓN DE SEGURIDAD Y SALUD EN EL TRABAJO**

Código SSOMA-F1-42

Revisión 02

Fecha 03/03/2017

Página 1/1

CONTROL DE ASISTENCIA**OBRA: Mejoramiento y Recuperación de los Servicios del DPA Supe****N° REGISTRO:** 005567**DATOS DEL EMPLEADOR**

RAZÓN SOCIAL O DENOMINACIÓN SOCIAL	RUC	DOMICILIO (Dirección, distrito, departamento, provincia)	ACTIVIDAD ECONÓMICA	N° DE TRABAJADORES DEL STAFF
Consorcio Marítimo del Norte	20602379320	Calle Vizcaya 187 San Luis - Lima	Construcción	15

TIPO DE EVENTO (MARCAR CON X)

INDUCCIÓN <input type="checkbox"/>	SIMULACRO DE EMERGENCIA <input type="checkbox"/>	CAPACITACION <input type="checkbox"/>
ENTRENAMIENTO <input type="checkbox"/>	CHARLA DE INICIO DE JORNADA <input checked="" type="checkbox"/>	OTROS <input type="checkbox"/>

TEMAS TRATADOSMANTENER LIMPIO EL SITIO DE TRABAJO

FECHA	07/02/2019	NUMERO DE CONVOCADOS	13
HORA DE INICIO	07 15:00 a m	NUMERO DE PARTICIPANTES	13
TIEMPO DE DURACIÓN	15 MINUTOS	NOMBRE DEL EXPOSITOR	F. MEJÍA
		FIRMA DEL EXPOSITOR	<i>[Firma]</i>

NRO.	APELLIDOS Y NOMBRE DE LOS PARTICIPANTES	DNI	AREA	EMPRESA	FIRMA	OBSERVACIONES
1	MORALES VIVALDO, DANIEL JOAQUIN	25622900	RESIDENTE	CMN	<i>[Firma]</i>	
2	VERA CASTAÑEDA, LUIS MIGUEL	42517924	ING ASISTENTE	CMN	<i>[Firma]</i>	
3	MEJIA ACOSTA, FRANKLIN ALFONSO	32762157	ING SSOMA	CMN	<i>[Firma]</i>	
4	MORALES CURI, HAROLD ANDREY	70913009	ASISTENTE TEC	CMN	<i>[Firma]</i>	
5	ESCALANTE PEPEZ, CHRISTOPHER JOSE	40075491	ING PRODUCCION	CMN	<i>[Firma]</i>	
6	GUADALUPE SANCHEZ, BUENAVENTURA	09000045	ADMINISTRADO	CMN	<i>[Firma]</i>	
7	AGUILO VILCA, JULIO VIDAL	41768501	ALMACENERO	CMN	<i>[Firma]</i>	
8	CRUZ BAZAN, GILBERTO	42903224	CONDUCTOR	CMN	<i>[Firma]</i>	
9	GALINDO VEGA, BRAYAN MAHAEL	72422711	ING CALIDAD	CMN	<i>[Firma]</i>	
10	TRUJILLO AVALOS HENRRY AURELIO	47626211	ALMACENERO	CMN	<i>[Firma]</i>	
11	SANTILLAN QUIROZ, JULIO	18945643	SANTARIO	CMN	<i>[Firma]</i>	
12	LEONTO ZUÑIGA, JOSE LUIS	41696679	COORDINADOR	CMN	<i>[Firma]</i>	
13	VELASQUEZ SALAZAR, CARLO MANUEL D	41131240	COORDINADOR	CMN	<i>[Firma]</i>	
14	BARRETO MALRICIO, RONALD	71263697	FRACITCANTE	CMN	<i>[Firma]</i>	
15	TACO GULLEN, DONATO	43557372	TOPOGRAFO	CMN	<i>[Firma]</i>	
16						
17						
18						
19						

RESPONSABLE DEL REGISTRO

Nombre:	FRANKLIN A. MEJIA ACOSTA
Cargo:	ING. SSOMA
Fecha:	07/02/2019
Firma:	<i>[Firma]</i>



SISTEMA DE GESTIÓN DE SEGURIDAD Y SALUD EN EL TRABAJO

Código: SSOMA-FI-42

Revisión: 00

Fecha: 30/02/2017

Página: 1/1

CONTROL DE ASISTENCIA

OBRA: Mejoramiento y Recuperación de los Servicios del DPA Supe

N° REGISTRO:

DATOS DEL EMPLEADOR

RAZÓN SOCIAL O DENOMINACIÓN SOCIAL	RUC	DOMICILIO (Dirección, distrito, departamento, provincia)	ACTIVIDAD ECONÓMICA	N° DE TRABAJADORES EN EL CENTRO LABORAL
Consorcio Marino del Norte	30602379820	Calle Vicosya 187 San Luis - Lima	Construcción	00

TIPO DE EVENTO (MARCAR CON X)

INDUCCIÓN SIMULACRO DE EMERGENCIA CAPACITACION
 ENTRENAMIENTO CHARLA DE INICIO DE JORNADA OTROS

TEMAS TRATADOS

MANTENER LIMPIO EL SITIO DE TRABAJO

FECHA: 07/02/19 NUMERO DE CONVOCADOS: 53
 HORA DE INICIO: 07:15:00 a.m. NUMERO DE PARTICIPANTES: 53
 TIEMPO DE DURACIÓN: 15 MINUTOS NOMBRE DEL EXPOSITOR: F. MEJIA
 FIRMA DEL EXPOSITOR: *[Signature]*

N°	APELLIDOS Y NOMBRE DE LOS PARTICIPANTES	DNI	AREA	EMPRESA	FIRMA	OBSERVACIONES
1	ABAD BULLON, NICOLAS GUIDO	20693793	OPERARIO	CMN	<i>[Signature]</i>	
2	ACOSTA DE LA CRUZ, EFRAIN	32604567	OPERARIO	CMN	<i>[Signature]</i>	
3	AGURTO SAAVEDRA SINAHY	42797670	OPERARIO	CMN	<i>[Signature]</i>	
4	ALVAREZ GILVONIO, FELIX RAUL	60633955	OPERARIO	CMN	<i>[Signature]</i>	
5	ALVAREZ GILVONIO, JAVIER	42377270	OFICIAL	CMN	<i>[Signature]</i>	
6	AMAYA VILLENA HENRY RAMON	33264710	OPERARIO	CMN	<i>[Signature]</i>	
7	AVILA MEZA, CLEMER	47794977	OFICIAL	CMN	<i>[Signature]</i>	
8	BACA ORELLANA, JUAN BERNARDINO	19942797	OPERARIO	CMN	<i>[Signature]</i>	
9	BELTRAN NAVARRO, LUIS RONNY	18176087	OPERARIO	CMN	<i>[Signature]</i>	
10	BERECHE GONZALES, NILL	449695058	OPERARIO	CMN	<i>[Signature]</i>	
11	BLAS AGUIRRE DIONICIO ALEJANDRO	73340111	OPERARIO	CMN	<i>[Signature]</i>	
12	BLAS AGUIRRE, JEAN CARLOS	73366416	OPERARIO	CMN	<i>[Signature]</i>	
13	BLAS CERNA, MAXIMO TEODORO	15658430	OPERARIO	CMN	<i>[Signature]</i>	
14	BLAS CERNA, PALOMINO ALEJANDRO	15846904	OPERARIO	CMN	<i>[Signature]</i>	
15	BLAS DOLORES, MAXIMO JACOB	48476798	OPERARIO	CMN	<i>[Signature]</i>	
16	CABANILLAS LLANOS, VICTOR	15653293	OPERARIO	CMN	<i>[Signature]</i>	
17	CABELLO BRAVO, SAMUEL CIRO	32730169	OPERARIO	CMN	<i>[Signature]</i>	
18	CALEPO CARBAJAL, GLODOALDO HECTOR	15702953	OPERARIO	CMN	<i>[Signature]</i>	
19	CALERU RODRIGUEZ, ELISEO URBANO	42236937	FEON	CMN	<i>[Signature]</i>	
20	CELESTINO DURAN, FRANK DAVID	77025343		CMN	<i>[Signature]</i>	

RESPONSABLE DEL REGISTRO

Nombre: FRANKLIN A. MEJIA ACOSTA
 Cargo: ING. SSOMA
 Fecha: 07/02/19
 Firma: *[Signature]*



SISTEMA DE GESTIÓN DE SEGURIDAD Y SALUD EN EL TRABAJO

Codigo: SSOMA-FT-42

Revisión: 03

Fecha: 2016/03/17

Página: 01

CONTROL DE ASISTENCIA

OBRA: Mejoramiento y Recuperación de los Servicios del DPA Supe

N° REGISTRO: 00000000

DATOS DEL EMPLEADOR

RAZÓN SOCIAL O DENOMINACIÓN SOCIAL	RUC	DOMICILIO (Dirección, distrito, departamento, provincia)	ACTIVIDAD ECONÓMICA	N° DE TRABAJADORES EN EL CENTRO LABORAL
Consorcio Marítimo del Norte	20502379320	Calle Vazaya 187 San Luis - Lima	Construcción	

TIPO DE EVENTO (MARCAR CON X)

INDUCCIÓN SIMULACRO DE EMERGENCIA CAPACITACION ENTRENAMIENTO CHARLA DE INICIO DE JORNADA OTROS

TEMAS TRATADOS

FECHA

NUMERO DE CONVOCADOS

HORA DE INICIO 07:15:00 a.m.

NUMERO DE PARTICIPANTES

TIEMPO DE DURACIÓN 16 MINUTOS

NOMBRE DEL EXPOSITOR

F. MEJÍA

FIRMA DEL EXPOSITOR

N°	APELLIDOS Y NOMBRE DE LOS PARTICIPANTES	DNI	AREA	EMPRESA	FIRMA	OBSERVACIONES
21	CELIS ROJAS EDWIN	39800233	MECANICO	CMN		
22	CHURA CUTIPA, SIRRIANO VICTOR	00491322	OFICIAL	CMN		
23	CISNEROS BALLONA, MAXIMO ALNIVAR	25729043	FERRERO	CMN		
24	CISNEROS HERRERA, LIONEL HERNAN	43342626	OPERARIO	CMN	R	
25	DE LA CRUZ SOTO, FRANKLIN MAY	70083602	PEON	CMN		
26	DE LA CRUZ, ATENCIO, MAXIMO PABLO	21093564	OPERARIO	CMN		
27	DELGADO CUEVA, CRISTIAN	80263614	PEON	CMN		
28	FASARI SHUPINGAHUA, PAUL	75834832	PEON	CMN		
29	FLORES PARIQONA, JANS EDU	70201666	PEON	CMN		
30	GARCIA CASIMIRO, GLIEX	06957676	OPERARIO	CMN		
31	GASPAR MEZA, AURELIO	19342564	OPERARIO	CMN		
32	GASPAR MEZA, JUAN PABLO	19843529	OPERARIO	CMN		
33	GASPAR SALOME, JOSE LUIZ	75509816	OPERARIO	CMN		
34	GENEBROZO FLORES, FIDEL ANGEL	40036826	OPERARIO	CMN		
35	GENEBROZO PAUCAR, MARLON, DEYVI	71537353	PEON	CMN		
36	GONZALES CARUAJULCA, LUIS	42078979	ELECTRICIST	CMN		
37	GONZALES MACHAGA, JUVENIL	48296606	OPERARIO	CMN	R	
38	GONZALES REYES, YONFER	42034141	OPERARIO	CMN		
39	GREGORIO RICRA, GILBERT ELI	42233257	PEON	CMN		
40	GUTIERREZ MONTES, ALEJANDRO	44777937	OPERARIO	CMN	R	

RESPONSABLE DEL REGISTRO

Nombre:

FRANKLIN A. MEJIA ACOSTA

Cargo:

ING. SSOMA

Fecha:

Firma:



SISTEMA DE GESTIÓN DE SEGURIDAD Y SALUD EN EL TRABAJO

Código: SSGMA-FI-42

Revisión: 01

Fecha: 00/00/2017

Página: 1/1

CONTROL DE ASISTENCIA

OBRA: Mejoramiento y Recuperación de los Servicios del DPA Supe

N° REGISTRO:

DATOS DEL EMPLEADOR

RAZÓN SOCIAL O DENOMINACIÓN SOCIAL	RUC	DOMICILIO (Dirección, distrito, departamento, provincia)	ACTIVIDAD ECONÓMICA	N° DE TRABAJADORES EN EL CENTRO LABORAL
Consorcio Marítimo del Norte	20602379320	Calle Vezcaya 187 San Luis - Lima	Construcción	000050

TIPO DE EVENTO (MARCAR CON X)

INDUCCIÓN <input type="checkbox"/>	SIMULACRO DE EMERGENCIA <input type="checkbox"/>	CAPACITACION <input type="checkbox"/>
ENTRENAMIENTO <input type="checkbox"/>	CHARLA DE INICIO DE JORNADA <input type="checkbox"/>	OTROS <input type="checkbox"/>

TEMAS TRATADOS

FECHA	HORA DE INICIO	TIEMPO DE DURACIÓN	NUMERO DE CONVOCADOS	NUMERO DE PARTICIPANTES	NOMBRE DEL EXPOSITOR	FIRMA DEL EXPOSITOR
	07 15 00 a m	15 MINUTOS			F. MEJIA	

N°	APELLIDOS Y NOMBRE DE LOS PARTICIPANTES	DNI	AREA	EMPRESA	FIRMA	OBSERVACIONES
61	SINCHE LAZO, MICHAEL	71390533	OPERARIO	CMN	<i>[Signature]</i>	
62	SOTO JARA, ELVIS KLEINER	15447991	PEON	CMN	<i>R</i>	
63	SOTO JARA, JÓRGE LUIS	45528071	PEON	CMN	<i>[Signature]</i>	
64	LIGARTE VASQUEZ, MAHUEL	47345541	PEON	CMN	<i>Manuel</i>	
65	VALVERDE OSORIO, OBSTAQUIO AGAPE	32763872	OPERADOR G	CMN	<i>[Signature]</i>	
66	VEGA ZORRILLA, WILLIAM KING	40181821	OPERARIO	CMN	<i>[Signature]</i>	
67	YUFANQUI AQUINO, WILSON	10631489	OFICIAL	CMN	<i>[Signature]</i>	
68	Herminio Noroey Juan	92576272	P		<i>[Signature]</i>	
69	Benito de la Cruz Yerson	72240042	Peon	CMN	<i>[Signature]</i>	
70	SPINOZA CURTIS JUAN / (DJU)	4646198	P	CMN	<i>[Signature]</i>	
71	MANUEL ZEÑA	09020237	Of	CMN	<i>[Signature]</i>	
72	Omar Ramirez Corales	7034954	Ay	CMN	<i>[Signature]</i>	
73	MANUEL VILLA RAMIRO	25542945	AY	CMN	<i>[Signature]</i>	
74	DNIEL RAMIREZ GUEVA	72715165	AY	CMN	<i>[Signature]</i>	
75	ORTEGA HALLER Juan carlos	42635420	AY	CMN	<i>[Signature]</i>	
76	Flores Cardo Juan A.	15665413	AY	CMN	<i>[Signature]</i>	
77						
78						
79						
80						

RESPONSABLE DEL REGISTRO

Nombre:	FRANKLIN A. MEJIA ACOSTA
Cargo:	ING. SSOMA
Fecha:	
Firma:	

Jueves 07 de Febrero 2019

MANTENER LIMPIO EL SITIO DE TRABAJO

Mantener el sitio de trabajo aseado y limpio no significa lo mismo para todas las personas, sino que puede representar diferentes niveles de limpieza. Lo que para una persona es aceptable en cuanto a la limpieza puede no serlo para otra. Las áreas de trabajo limpias se ven influenciadas por dos cosas: lo que hacemos (o nos negamos a hacer) y el clima. Se pueden controlar la mayoría de las condiciones, pero para las condiciones que no pueden ser controladas, se debe estar pendiente para cuidar ó remover. Si bien no se puede evitar que el clima genere malas condiciones, se pueden planear con anticipación las acciones necesarias a tomar. Hacer limpieza general una vez a la semana no garantiza la seguridad en el sitio de trabajo. Seguramente usted ha visto áreas donde no era seguro voltearse o apoyar un pie sin tener que mirar dos veces para asegurarse de que no había algo que pudiera causarle un accidente. Un sitio de trabajo de construcción con estas características está siendo administrado ineficazmente. No es solamente inseguro, sino que además no crea relaciones convenientes entre el dueño y el público.

Prácticas seguras:

Recoja basura, escombros y desperdicios y ubíquelos en lugares designados para ello. Asegúrese de que los materiales no puedan desplazarse hacia otras áreas. Remueva objetos que puedan generar peligros aún cuando no lo aparenten. Almacene los materiales para que haya siempre un camino limpio alrededor y entre las áreas de trabajo, como también en la entrada y salida. No ubique objetos en las salidas del sitio de trabajo. Mantenga los pisos, peldaños de escaleras y escaleras secas y libres de aceites o líquidos grasosos. Coloque las herramientas y los equipos en los lugares pertinentes. No almacene materiales sueltos sobre los andamios. No almacene más de una pieza de material (por ejemplo bloques o ladrillos) sobre los andamios. Asegúrese de que el material que almacena sobre el andamio, va a mantenerse estable al momento de ser removido. Deje espacio para que los trabajadores y equipos puedan cargar y descargar los materiales almacenados. Asegúrese de que la plataforma, andamios o soporte tengan la resistencia adecuada para el peso del material. Mantenga los materiales almacenados a baja altura para mayor estabilidad y para verlos claramente. Almacene los tubos y varillas en estantes. Despeje desechos de madera con clavos sobresalientes de las áreas de trabajo, pasillos y escaleras en ó alrededor de edificios u otras estructuras. Remueva los desechos combustibles y escombros de un modo regular. Provea recipientes para la recolección de desperdicios, basura, aceites, fábricas utilizadas y cualquier otro desecho. Asegúrese de que los recipientes para desperdicios aceitosos, inflamables y peligrosos (como cáusticos y ácidos) estén equipados con tapas. No tire materiales hacia afuera de las paredes del edificio o estructura. Incluya canales con inclinación para materiales. Proteja la apertura y descarga de los canales inclinados. No deje recipientes de líquidos abiertos: gasolina, pintura, aceites, grasa, adhesivos, etc. Asegúrese de que el sitio tenga buena iluminación. Reemplace inmediatamente las bombillas cuando se fundan. Recuerde que si permite que los desperdicios se acumulen por tan sólo unos días, el sitio de construcción se vuelve sucia e insegura.



SISTEMA DE GESTIÓN DE SEGURIDAD Y SALUD EN EL TRABAJO

Código: SSOMA-FT-42

Revisión: 00

Fecha: 20/08/2017

Páginas: 1/1

CONTROL DE ASISTENCIA

OBRA: Mejoramiento y Recuperación de los Servicios del DPA Supa

N° REGISTRO:

DATOS DEL EMPLEADOR

RAZÓN SOCIAL O DENOMINACIÓN SOCIAL	RUC	DOMICILIO (Dirección, distrito, departamento, provincia)	ACTIVIDAD ECONÓMICA	N° DE TRABAJADORES DEL STAFF
Consortio Marítimo del Norte	20602378320	Calle Vizcaya 187. San Luis - Lima	Construcción	15

INDUCCIÓN
ENTRENAMIENTO

TIPO DE EVENTO (MARCAR CON X)

SIMULACRO DE EMERGENCIA
CHARLA DE INICIO DE JORNADA

CAPACITACIÓN
OTROS

TEMAS TRATADOS

INSPECCIONES

FECHA 12/02/2019
HORA DE INICIO 07:15:00 a.m.
TIEMPO DE DURACIÓN 15 MINUTOS

NUMERO DE CONVOCADOS

15

NUMERO DE PARTICIPANTES

10

NOMBRE DEL EXPOSITOR

F. MEJÍA

FIRMA DEL EXPOSITOR

	APELLIDOS Y NOMBRE DE LOS PARTICIPANTES	DNI	AREA	EMPRESA	FIRMA	OBSERVACIONES
1	MORALES VIVANCO, DANIEL JOAQUIN	25595800	RESIDENTE	CMN		
2	VERA CASTAÑEDA, LUIS MIGUEL	42517924	ING ASISTENTE	CMN		
3	MEJIA ACOSTA, FRANKLIN ALFONSO	32762157	ING SSOMA	CMN		
4	MORALES CURI, HAROLD ANDREY	70913009	ASISTENTE TEC	CMN		
5	ESCALANTE PEREZ, CHRISTOPHER JOSE	46075491	ING PRODUCCI	CMN		
6	GUADALUPE SANCHEZ, BUENAVENTURA	09000045	ADMINISTRADO	CMN	—	
7	AQUINO VILCA, JULIO VIDAL	41756501	ALMACENERO	CMN	—	
8	CRUZ BAZAN, GILBERTO	42509324	CONDUCTOR	CMN		
9	GALINDO VEGA, BRAYAN MICHAEL	72422711	ING CALIDAD	CMN		
10	RUIJILLO AVALOS HENRRY AURELIO	47626241	ALMACENERO	CMN		
11	SANTILLAN QUIROZ, JULIO	18845643	SANITARIO	CMN	—	
12	LERMO ZUÑIGA, JOSE LUIS	41690575	COORDINADOR	CMN	—	
13	VELASQUEZ SALAZAR, CARLO MANUEL D.	41190240	COORDINADOR	CMN	—	
14	BARRETO MAURICIO, RONALD	71263697	PRACTICANTE	CMN		
15	TACO GUILLEN, DONATO	43557372	TOPOGRAFO	CMN		
16						
17						
18						
19						

RESPONSABLE DEL REGISTRO

Nombre:

FRANKLIN A. MEJIA ACOSTA

Cargo:

ING. SSOMA

Fecha:

12/02/2019

Firma:



SISTEMA DE GESTIÓN DE SEGURIDAD Y SALUD EN EL TRABAJO

Código: SSOMA-FT-42

Revisión: 00

Fecha: 20/09/2017

Página: 1/1

CONTROL DE ASISTENCIA

OBRA: Mejoramiento y Recuperación de los Servicios del DPA Supe

N° REGISTRO:

DATOS DEL EMPLEADOR

RAZÓN SOCIAL O DENOMINACIÓN SOCIAL	RUC	DOMICILIO (Dirección, distrito, departamento, provincia)	ACTIVIDAD ECONÓMICA	N° DE TRABAJADORES EN EL CENTRO LABORAL
Consorcio Marítimo del Norte	20602379320	Calle Vizcaya 187. San Luis - Lima	Construcción	000056

TIPO DE EVENTO (MARCAR CON X)

INDUCCIÓN SIMULACRO DE EMERGENCIA CAPACITACIÓN ENTRENAMIENTO CHARLA DE INICIO DE JORNADA OTROS

TEMAS TRATADOS

INSPECCIONES

FECHA

12/02/2019

NUMERO DE CONVOCADOS

51

HORA DE INICIO

07:15:00 a.m.

NUMERO DE PARTICIPANTES

51

TIEMPO DE DURACIÓN

15 MINUTOS

NOMBRE DEL EXPOSITOR

F. MEJÍA

FIRMA DEL EXPOSITOR

[Firma]

	APELLIDOS Y NOMBRE DE LOS PARTICIPANTES	DNI	AREA	EMPRESA	FIRMA	OBSERVACIONES
1	ABAD BULLON, NICOLAS GUIDO	20699793	OPERARIO	CMN	<i>[Firma]</i>	
2	ACOSTA DE LA CRUZ, EFRAIN	32904567	OPERARIO	CMN	<i>[Firma]</i>	
3	ALVAREZ GILVONIO, FELIX RAUL	80633355	OPERARIO	CMN	<i>[Firma]</i>	
4	ALVAREZ GILVONIO, JAVIER	42377270	OFICIAL	CMN	<i>[Firma]</i>	
5	BELTRAN NAVARRO, LUIS RONNY	16176087	OPERARIO	CMN	<i>[Firma]</i>	
6	BENITO DE LA CRUZ, YERSION YAK	72240042	PINTOR	CMN	<i>[Firma]</i>	
7	BERECHE GONZALES, NILL	449895058	OPERARIO	CMN	<i>[Firma]</i>	
8	BLAS AGUIRRE, DIONICIO ALEJANDRO	15848984	OPERARIO	CMN	—	
9	BLAS AGUIRRE, JEAN CARLOS	73336646	OPERARIO	CMN	—	
10	BLAS CERNA, MAXIMO TEODORO	15856430	OPERARIO	CMN	<i>[Firma]</i>	
11	BLAS CERNA, PALOMINO ALEJANDRO	15848984	OPERARIO	CMN	<i>[Firma]</i>	
12	BLAS DOLORES, MAXIMO JACOB	48476798	OPERARIO	CMN	<i>[Firma]</i>	
13	CABANILLAS LLANOS, VICTOR	15853293	OPERARIO	CMN	<i>[Firma]</i>	
14	CABELLO BRAVO, SAMUEL CIRO	32730189	OPERARIO	CMN	<i>[Firma]</i>	
15	CALERO RODRIGUEZ, ELISEO URBANO	42238937	PEON	CMN	<i>[Firma]</i>	
16	CELESTINO DURAN, FRANK DAVID	77025343		CMN	—	
17	CELIS ROJAS EDWIN	25809233	MECANICO	CMN	<i>[Firma]</i>	
18	CHURA CUTIPA, SIPRIANO VICTOR	00491322	OFICIAL	CMN	<i>[Firma]</i>	
19	CISNEROS BALLONA, MAXIMO ALNIVAR	25799043	FIERRERO	CMN	<i>[Firma]</i>	
20	DE LA CRUZ SOTO, FRANCKLIN MAX	70083602	PEON	CMN	<i>[Firma]</i>	

RESPONSABLE DEL REGISTRO

Nombre:

FRANKLIN A. MEJIA ACOSTA

Cargo:

ING. SSOMA

Fecha:

12/02/2019

Firma:

[Firma]



SISTEMA DE GESTIÓN DE SEGURIDAD Y SALUD EN EL TRABAJO

Código: SSOMA-FT-42

Revisión: 00

Fecha: 20/09/2017

Página: 1/1

CONTROL DE ASISTENCIA

OBRA: Mejoramiento y Recuperación de los Servicios del DPA Supe

N° REGISTRO:

DATOS DEL EMPLEADOR

RAZÓN SOCIAL O DENOMINACIÓN SOCIAL	RUC	DOMICILIO (Dirección, distrito, departamento, provincia)	ACTIVIDAD ECONÓMICA	N° DE TRABAJADORES EN EL CENTRO LABORAL
Consorcio Marítimo del Norte	20602379320	Calle Vizcaya 187. San Luis - Lima	Construcción	055

INDUCCIÓN ENTRENAMIENTO

TIPO DE EVENTO (MARCAR CON X)

SIMULACRO DE EMERGENCIA CHARLA DE INICIO DE JORNADA CAPACITACIÓN OTROS

TEMAS TRATADOS

FECHA

HORA DE INICIO 07:15:00 a.m.

TIEMPO DE DURACIÓN 15 MINUTOS

NUMERO DE CONVOCADOS

NUMERO DE PARTICIPANTES

NOMBRE DEL EXPOSITOR

FIRMA DEL EXPOSITOR

F. MEJÍA

	APELLIDOS Y NOMBRE DE LOS PARTICIPANTES	DNI	ÁREA	EMPRESA	FIRMA	OBSERVACIONES
21	DE LA CRUZ, ATENCIO, MAXIMO PABLO	21093564	OPERARIO	CMN	<i>[Signature]</i>	
22	DELGADO GUEVA, CRISTIAN	80283814	PEON	CMN	<i>[Signature]</i>	
23	FASABI SHUPINGAHUA, PAUL	75834892	PEON	CMN	<i>[Signature]</i>	
24	FLORES CARO, JUAN	15666419	PINTOR	CMN	<i>[Signature]</i>	
25	FLORES PARIONA, JANS EDU	70291686	PEON	CMN	<i>[Signature]</i>	
26	GARCIA CASIMIRO, GUIDO	06857676	OPERARIO	CMN	<i>[Signature]</i>	
27	GASPAR MEZA, AURELIO	19942564	OPERARIO	CMN	<i>[Signature]</i>	
28	GASPAR MEZA, JUAN PABLO	19940529	OPERARIO	CMN	<i>[Signature]</i>	
29	GASPAR SALOME, JOSE LUIZ	75508816	OPERARIO	CMN	<i>[Signature]</i>	
30	GENEBROZO FLORES, FIDEL ANGEL	40006826	OPERARIO	CMN	<i>[Signature]</i>	
	GENEBROZO PAUCAR, MARLON, DEYVI	71537353	PEON	CMN	<i>[Signature]</i>	
32	GONZALES REYES, YONFER	48084141	OPERARIO	CMN	<i>[Signature]</i>	
33	GREGORIO RICRA, GILBERT ELI	42233257	PEON	CMN	<i>[Signature]</i>	
34	HERQUINIO ALVAREZ, GIANMARCO	48106372	PEON	CMN	<i>[Signature]</i>	
35	HERQUINIO ALVAREZ, JUAN ROLANDO	42376272	PINTOR	CMN	<i>[Signature]</i>	
36	HUAMAN SOTOMAYOR, GREGORIO	40016313	OPERARIO	CMN	<i>[Signature]</i>	
37	JARA FLORES, JORGE LUIS	42893317	PEON	CMN	<i>[Signature]</i>	
38	MOGOLLON ALBURQUEQUE, CARLOS HECTOR	3874802	OPERARIO	CMN	<i>[Signature]</i>	
39	MONTES GUILLEN, ALBERTO	19832553	OPERARIO	CMN	<i>[Signature]</i>	
40	MORALES PISCOYA, PEDRO	17555912	OPERARIO	CMN	<i>[Signature]</i>	

RESPONSABLE DEL REGISTRO

Nombre: FRANKLIN A. MEJIA ACOSTA
 Cargo: ING. SSOMA
 Fecha:
 Firma:



SISTEMA DE GESTIÓN DE SEGURIDAD Y SALUD EN EL TRABAJO

Código: SSOMA-FT-42

Revisión: 00

Fecha: 20/09/2017

Página: # 0054

CONTROL DE ASISTENCIA

OBRA: Mejoramiento y Recuperación de los Servicios del DPA Supe

N° REGISTRO: _____

DATOS DEL EMPLEADOR

RAZÓN SOCIAL O DENOMINACIÓN SOCIAL	RUC	DOMICILIO (Dirección, distrito, departamento, provincia)	ACTIVIDAD ECONÓMICA	N° DE TRABAJADORES EN EL CENTRO LABORAL
Consortio Marítimo del Norte	20602379320	Calle Vizcaya 187. San Luis - Lima	Construcción	

TIPO DE EVENTO (MARCAR CON X)

INDUCCIÓN SIMULACRO DE EMERGENCIA CAPACITACIÓN ENTRENAMIENTO CHARLA DE INICIO DE JORNADA OTROS

TEMAS TRATADOS

FECHA

NUMERO DE CONVOCADOS

HORA DE INICIO 07:15:00 a.m.

NUMERO DE PARTICIPANTES

TIEMPO DE DURACIÓN 15 MINUTOS

NOMBRE DEL EXPOSITOR

F. MEJÍA

FIRMA DEL EXPOSITOR

D.	APELLIDOS Y NOMBRE DE LOS PARTICIPANTES	DNI	AREA	EMPRESA	FIRMA	OBSERVACIONES
41	MOYA LOPEZ, WILDER	45177800	PINTOR	CMN		
42	OBREGON TREJO, CRISTIAN RONALD	72535185	PEON	CMN		
43	OLIVOS MACO, CHARLES	41404659	OPERARIO	CMN		
44	ORTIZ CHAHUA, JUAN CARLOS	42635420	PEON	CMN		
45	PERALES ZEVALLOS, NOE MAXIMO	44505979	OPERARIO	CMN		
46	RAMIREZ CORRALES, OMAR ALDAIR	70349324	PINTOR	CMN		
47	RAMIREZ CUEVA, CARLOS DANIEL	72715465	PINTOR	CMN		
48	RIVERA SOTOMAYOR, LUCIANO	10064683	MAESTRO	CMN		
49	RODRIGUEZ CHUMBES, ARTURO	41942549	OPERARIO	CMN		
50	SAAVEDRA CORTEZ, RHOLY JHONSTON	42139151	OPERARIO	CMN		
51	SALAS AMACIFUEN, REITER	40915271	ALBAÑIL	CMN		
52	SANCHEZ LOPEZ, LUIS MIGUEL	44855504	PEON	CMN		
53	SINCHE LAZO, MICHAEL	71390533	OPERARIO	CMN		
54	SOTO JARA, JORGE LUIS	45528371	PEON	CMN		
55	UGARTE VASQUEZ, MANUEL	47345541	PEON	CMN		
56	VALVERDE OSORIO, OBSTAQUIO AGAPE	32763872	OPERADOR G	CMN		
57	VEGA ZORRILLA, WILLIAM KING	40181821	OPERARIO	CMN		
58	VILLA PANTA, MANUEL MESIAS	25542945	PINTOR	CMN		
59	YUPANQUI AQUINO, WILSON	10631469	OFICIAL	CMN		
60	ZEÑA SANTA MARIA, MANUEL	09020237	PINTOR	CMN		

RESPONSABLE DEL REGISTRO

Nombre:

FRANKLIN A. MEJIA ACOSTA

Cargo:

ING. SSOMA

Fecha:

Firma:

Martes 12 de Febrero 2019

Inspecciones

El propósito de una inspección de seguridad es, encontrar las cosas que causan o ayudan a causar accidentes. Yo preguntaría: Sr. Supervisor, cuántas inspecciones se realizan a los sistemas de incendio, luces de emergencias, escaleras de mano, calderas, orden y limpieza, etc.?

Esto parece que es mucho inspeccionar. Y lo es, a demás que cuesta dinero. Pero es necesario, pues de otra manera no lo harían. Las empresas generalmente no son tontas, no gastan dinero en cosas que no son necesarias, por lo tanto podemos estar seguros que las inspecciones pagan.

Pero yo quiero llegar a convencerlos de que también pagarían para todos si todo el mundo hiciera un poco de inspección, ya que solos los supervisores no tienen el tiempo suficiente de inspeccionar las cosas tan a menudo como lo requieren. Por lo tanto es necesario pedir ayuda a todo el personal.

Tal vez ustedes no se dan cuenta, pero muchas de las cosas equivocadas que hay en una empresa se pueden prevenir por medio de una inspección apropiada. Y esto es cierto para toda la empresa y particularmente para los accidentes. No solamente aquellos causados por una escalera en mal estado, o la cabeza suelta de un martillo. Una avería de cualquier clase aumenta la probabilidad de accidentes porque causa confusión y ordinariamente crea riesgos.

En la mayoría de los casos de accidentes, se pueden prevenir con un buen trabajo de inspección, el cual permite evita lesiones, corrigiéndose los defectos. Cuando se realizan trabajos en diferentes turnos, se deben mirar bien las cosas, a su alrededor. Hay algo que estorbe?. Esto quiere decir que halla bajo sus pies un piso limpio, parejo, no deslizante, sin manchas de aceite, sin objetos que interrumpen la circulación, etc.

Las caídas causan o contribuyen a muchos accidentes. Uno puede torcerse un tobillo o una rodilla, o romperse un dedo o dos, lastimarse la muñeca, etc. Incluso en recintos cerrados uno se puede golpear la cabeza.

Sr. Supervisor: Se puede mejorar esto haciendo que sus hombres sugieran cosas que se deben inspeccionar a menudo. También puede hacer que algunos la digan cuales son las cosas que ellos piensan que deben inspeccionar y que mirarían en sus inspecciones



SISTEMA DE GESTIÓN DE SEGURIDAD Y SALUD EN EL TRABAJO

Código: SSOMA-FT-452
 Revisión: 00
 Fecha: 20/09/2017
 Página: 1/1

CONTROL DE ASISTENCIA

OBRA: Mejoramiento y Recuperación de los Servicios del DPA Supe

N° REGISTRO:

RAZÓN SOCIAL O DENOMINACIÓN SOCIAL	RUC	DOMICILIO (Dirección, distrito, departamento, provincia)	ACTIVIDAD ECONÓMICA	N° DE TRABAJADORES DEL STAFF
Consorcio Marítimo del Norte	20602379320	Calle Vizcaya 187, San Luis - Lima	Construcción	15

INDUCCIÓN
 ENTRENAMIENTO

TIPO DE EVENTO (MARCAR CON X)
 SIMULACRO DE EMERGENCIA
 CHARLA DE INICIO DE JORNADA

CAPACITACIÓN
 OTROS

TEMAS TRATADOS
LAS BIOMAS PESADAS SON PELIGROSAS

FECHA: 15/02/2019
 HORA DE INICIO: 07:15:00 a.m.
 TIEMPO DE DURACIÓN: 15 MINUTOS

NUMERO DE CONVOCADOS: 15
 NUMERO DE PARTICIPANTES: 11
 NOMBRE DEL EXPOSITOR: F. MEJIA
 FIRMA DEL EXPOSITOR: *[Signature]*

	APELLIDOS Y NOMBRE DE LOS PARTICIPANTES	DNI	AREA	EMPRESA	FIRMA	OBSERVACIONES
1	MORALES VIVANCO, DANIEL JOAQUIN	25595900	RESIDENTE	CMN		
2	VERA CASTAÑEDA, LUIS MIGUEL	42517924	ING ASISTENTE	CMN		
3	MEJIA ACOSTA, FRANKLIN ALFONSO	32762157	ING SSOMA	CMN		
4	MORALES CURI, HAROLD ANDREY	70913009	ASISTENTE TEC	CMN		
5	ESCALANTE PEREZ, CHRISTOPHER JOSE	48075491	ING PRODUCCI	CMN		
6	GUADALUPE SANCHEZ, BUENAVENTURA	09000045	ADMINISTRADO	CMN		
7	AQUINO VILCA, JULIO VIDAL	41756501	ALMACENERO	CMN		
8	CRUZ BAZAN, GILBERTO	42509324	CONDUCTOR	CMN		
9	GALINDO VEGA, BRAYAN MICHAEL	72422711	ING CALIDAD	CMN		
	JILLO AVALOS HENRRY AURELIO	47626241	ALMACENERO	CMN		
11	SANTILLAN QUIROZ, JULIO	18845643	SANITARIO	CMN		
12	LERMO ZUÑIGA, JOSE LUIS	41690575	COORDINADOR	CMN		
13	VELASQUEZ SALAZAR, CARLO MANUEL D.	41180240	COORDINADOR	CMN		
14	BARRETO MAURICIO, RONALD	71263697	PRACTICANTE	CMN		
15	TACO GUILLEN, DONATO	43557372	TOPOGRAFO	CMN		
16						
17						
18						
19						

RESPONSABLE DEL REGISTRO

Nombre: FRANKLIN A. MEJIA ACOSTA
 Cargo: ING. SSOMA
 Fecha: 15/02/2019
 Firma: *[Signature]*

**SISTEMA DE GESTIÓN DE SEGURIDAD Y SALUD EN EL TRABAJO**Código: SSOMA-FT-42
Revisión: 00
Fecha: 20/09/2017
Página: 1/1**CONTROL DE ASISTENCIA****OBRA:** Mejoramiento y Recuperación de los Servicios del DPA Supe**N° REGISTRO:****DATOS DEL EMPLEADOR**

RAZÓN SOCIAL O DENOMINACIÓN SOCIAL	RUC	DOMICILIO (Dirección, distrito, departamento, provincia)	ACTIVIDAD ECONÓMICA	N° DE TRABAJADORES EN EL CENTRO LABORAL
Consortio Marítimo del Norte	20602379320	Calle Vizcaya 187. San Luis - Lima	Construcción	

INDUCCIÓN SIMULACRO DE EMERGENCIA CAPACITACIÓN
 ENTRENAMIENTO CHARLA DE INICIO DE JORNADA OTROS

TEMAS TRATADOSLAS BROMAS PESADAS SON PELIGROSAS

FECHA 15/02/2019 NUMERO DE CONVOCADOS 50
 HORA DE INICIO 07:15:00 a.m. NUMERO DE PARTICIPANTES 50
 TIEMPO DE DURACIÓN 15 MINUTOS NOMBRE DEL EXPOSITOR F. MEJIA
 FIRMA DEL EXPOSITOR [Firma]

	APELLIDOS Y NOMBRE DE LOS PARTICIPANTES	DNI	AREA	EMPRESA	FIRMA	OBSERVACIONES
1	ABAD BULLON, NICOLAS GUIDO	20699793	OPERARIO	CMN	[Firma]	
2	ACOSTA DE LA CRUZ, EFRAIN	32904567	OPERARIO	CMN	[Firma]	
3	ALVAREZ GILVONIO, FELIX RAUL	80633355	OPERARIO	CMN	[Firma]	
4	ALVAREZ GILVONIO, JAVIER	42377270	OFICIAL	CMN	[Firma]	
5	BELTRAN NAVARRO, LUIS RONNY	16176087	OPERARIO	CMN	[Firma]	
6	BENITO DE LA CRUZ, YERSION YAK	72240042 72240042	PINTOR	CMN	[Firma]	
7	BERECHE GONZALES, NILL	449895058	OPERARIO	CMN	[Firma]	
8	BLAS AGUIRRE, DIONICIO ALEJANDRO	15848984	OPERARIO	CMN	[Firma]	
9	BLAS AGUIRRE, JEAN CARLOS	73336646	OPERARIO	CMN	[Firma]	
10	BLAS CERNA, MAXIMO TEODORO	15856430	OPERARIO	CMN	[Firma]	
11	BLAS CERNA, PALOMINO ALEJANDRO	15848984	OPERARIO	CMN	[Firma]	
12	BLAS DOLORES, MAXIMO JACOB	48476798	OPERARIO	CMN	[Firma]	
13	CABANILLAS LLANOS, VICTOR	15853293	OPERARIO	CMN	[Firma]	
14	CABELLO BRAVO, SAMUEL CIRO	32730189	OPERARIO	CMN	[Firma]	
15	CALERO RODRIGUEZ, ELISEO URBANO	42238937	PEON	CMN	[Firma]	
16	CELESTINO DURAN, FRANK DAVID	77025343		CMN	[Firma]	
17	CELIS ROJAS EDWIN	25809233	MECANICO	CMN	[Firma]	
18	CHURA CUTIPA, SIPRIANO VICTOR	00491322	OFICIAL	CMN	[Firma]	
19	CISNEROS BALLONA, MAXIMO ALNIVAR	25799043	FIERRERO	CMN	[Firma]	
20	DE LA CRUZ SOTO, FRANKLIN MAX	70083602	PEON	CMN	[Firma]	

RESPONSABLE DEL REGISTRO

Nombre: **FRANKLIN A. MEJIA ACOSTA**
 Cargo: **ING. SSOMA**
 Fecha: 15/02/2019
 Firma: [Firma]



SISTEMA DE GESTIÓN DE SEGURIDAD Y SALUD EN EL TRABAJO

CONTROL DE ASISTENCIA

Código: SSOMA-FT-420

Revisión: 06

Fecha: 20/09/2017

Página: 1/1

OBRA: Mejoramiento y Recuperación de los Servicios del DPA Supe**N° REGISTRO:****DATOS DEL EMPLEADOR**

RAZÓN SOCIAL O DENOMINACIÓN SOCIAL	RUC	DOMICILIO (Dirección, distrito, departamento, provincia)	ACTIVIDAD ECONÓMICA	N° DE TRABAJADORES EN EL CENTRO LABORAL
Consorcio Marítimo del Norte	20602379320	Calle Vizcaya 187, San Luis - Lima	Construcción	

INDUCCIÓN

ENTRENAMIENTO

TIPO DE EVENTO (MARCAR CON X)

SIMULACRO DE EMERGENCIA

CHARLA DE INICIO DE JORNADA

CAPACITACIÓN

OTROS

TEMAS TRATADOS

FECHA

HORA DE INICIO 07:15:00 a.m.

TIEMPO DE DURACIÓN 15 MINUTOS

NUMERO DE CONVOCADOS

NUMERO DE PARTICIPANTES

NOMBRE DEL EXPOSITOR

FIRMA DEL EXPOSITOR

F. MEJIA

APELLIDOS Y NOMBRE DE LOS PARTICIPANTES

	APELLIDOS Y NOMBRE DE LOS PARTICIPANTES	DNI	AREA	EMPRESA	FIRMA	OBSERVACIONES
21	DE LA CRUZ, ATENCIO, MAXIMO PABLO	21093564	OPERARIO	CMN		
22	DELGADO CUEVA, CRISTIAN	80283814	PEON	CMN		
23	FASABI SHUPINGAHUA, PAUL	75834892	PEON	CMN		
24	FLORES CARO, JUAN	15666419	PINTOR	CMN		
25	FLORES PARIONA, JANS EDU	70291686	PEON	CMN		
26	GARCIA CASIMIRO, GUIDO	06857676	OPERARIO	CMN		
27	GASPAR MEZA, AURELIO	19942564	OPERARIO	CMN		
28	GASPAR MEZA, JUAN PABLO	19940529	OPERARIO	CMN		
29	GASPAR SALOME, JOSE LUIZ	75508816	OPERARIO	CMN		
30	GENEBROZO FLORES, FIDEL ANGEL	40006826	OPERARIO	CMN		
31	GENEBROZO PAUCAR, MARLON, DEYVI	71537353	PEON	CMN		
32	GONZALES REYES, YONFER	48084141	OPERARIO	CMN		
33	GREGORIO RICRA, GILBERT ELI	42233257	PEON	CMN		
34	HERQUINIO ALVAREZ, GIANMARCO	48106372	PEON	CMN		
35	HERQUINIO ALVAREZ, JUAN ROLANDO	42376272	PINTOR	CMN		
36	HUAMAN SOTOMAYOR, GREGORIO	40016313	OPERARIO	CMN		
37	JARA FLORES, JORGE LUIS	42893317	PEON	CMN		
38	MOGOLLON ALBURQUEQUE, CARLOS HECTOR	3874802	OPERARIO	CMN		
39	MONTES GUILLEN, ALBERTO	19832553	OPERARIO	CMN		
40	MORALES PISCOYA, PEDRO	17555912	OPERARIO	CMN		

RESPONSABLE DEL REGISTRO

Nombre:

Cargo:

Fecha:

Firma:

FRANKLIN A. MEJIA ACOSTA

ING. SSOMA



SISTEMA DE GESTIÓN DE SEGURIDAD Y SALUD EN EL TRABAJO

Código: SSOMA-FT-42

Revisión: 00

Fecha: 20/09/2017

Página: 1/1

CONTROL DE ASISTENCIA

OBRA: Mejoramiento y Recuperación de los Servicios del DPA Supe

N° REGISTRO: 0049

DATOS DEL EMPLEADOR				
RAZÓN SOCIAL O DENOMINACIÓN SOCIAL	RUC	DOMICILIO (Dirección, distrito, departamento, provincia)	ACTIVIDAD ECONÓMICA	N° DE TRABAJADORES EN EL CENTRO LABORAL
Consortio Marítimo del Norte	20602379320	Calle Vizcaya 187. San Luis - Lima	Construcción	

INDUCCIÓN ENTRENAMIENTO

TIPO DE EVENTO (MARCAR CON X)

SIMULACRO DE EMERGENCIA CHARLA DE INICIO DE JORNADA CAPACITACIÓN OTROS

TEMAS TRATADOS

FECHA

HORA DE INICIO 07:15:00 a.m.

TIEMPO DE DURACIÓN 15 MINUTOS

NUMERO DE CONVOCADOS

NUMERO DE PARTICIPANTES

NOMBRE DEL EXPOSITOR

FIRMA DEL EXPOSITOR

F MEJÍA

	APELLIDOS Y NOMBRE DE LOS PARTICIPANTES	DNI	AREA	EMPRESA	FIRMA	OBSERVACIONES
41	MOYA LOPEZ, WILDER	45177800	PINTOR	CMN		
42	OBREGON TREJO, CRISTIAN RONALD	72535185	PEON	CMN		
43	OLIVOS MACO, CHARLES	41404659	OPERARIO	CMN		
44	ORTIZ CHAHUA, JUAN CARLOS	42635420	PEON	CMN		
45	PERALES ZEVALLOS, NOE MAXIMO	44505979	OPERARIO	CMN		
46	RAMIREZ CORRALES, OMAR ALDAIR	70349324	PINTOR	CMN		
47	RAMIREZ CUEVA, CARLOS DANIEL	72715465	PINTOR	CMN		
48	RIVERA SOTOMAYOR, LUCIANO	10064683	MAESTRO	CMN		
49	RODRIGUEZ CHUMBES, ARTURO	41942549	OPERARIO	CMN		
50	SAAVEDRA CORTEZ, RHOLY JHONSTON	42139151	OPERARIO	CMN		
51	SALAS AMACIFUEN, REITER	40915271	ALBAÑIL	CMN		
52	SANCHEZ LOPEZ, LUIS MIGUEL	44855504	PEON	CMN		
53	SINCHE LAZO, MICHAEL	71390533	OPERARIO	CMN		
54	SOTO JARA, JORGE LUIS	45528371	PEON	CMN		
55	UGARTE VASQUEZ, MANUEL	47345541	PEON	CMN		
56	VALVERDE OSORIO, OBSTAQUIO AGAPE	32763872	OPERADOR G	CMN		
57	VEGA ZORRILLA, WILLIAM KING	40181821	OPERARIO	CMN		
58	VILLA PANTA, MANUEL MESIAS	25542945	PINTOR	CMN		
59	YUPANQUI AQUINO, WILSON	10631469	OFICIAL	CMN		
60	ZEÑA SANTA MARIA, MANUEL	09020237	PINTOR	CMN		

RESPONSABLE DEL REGISTRO

Nombre:

Cargo:

Fecha:

Firma:

FRANKLIN A. MEJIA ACOSTA

ING. SSOMA



SISTEMA DE GESTIÓN DE SEGURIDAD Y SALUD EN EL TRABAJO

Código: SSOMA-FT-42

Revisión: 00

Fecha: 20/09/2017

Página: 1/1

CONTROL DE ASISTENCIA

OBRA: Mejoramiento y Recuperación de los Servicios del DPA Supe

N° REGISTRO: 600

RAZÓN SOCIAL O DENOMINACIÓN SOCIAL		RUC	DATOS DEL EMPLEADOR		ACTIVIDAD ECONÓMICA	N° DE TRABAJADORES EN EL CENTRO LABORAL
			DOMICILIO (Dirección, distrito, departamento, provincia)			
Consortio Marítimo del Norte		20602379320	Calle Vizcaya 187. San Luis - Lima		Construcción	

INDUCCIÓN

ENTRENAMIENTO

TIPO DE EVENTO (MARCAR CON X)

SIMULACRO DE EMERGENCIA

CHARLA DE INICIO DE JORNADA

CAPACITACIÓN

OTROS

TEMAS TRATADOS

FECHA

HORA DE INICIO 07:15:00 a.m.

TIEMPO DE DURACIÓN 15 MINUTOS

NUMERO DE CONVOCADOS

NUMERO DE PARTICIPANTES

NOMBRE DEL EXPOSITOR

FIRMA DEL EXPOSITOR

F. MEJÍA

APELLIDOS Y NOMBRE DE LOS PARTICIPANTES

DNI

AREA

EMPRESA

FIRMA

OBSERVACIONES

61	Matosalva Uriarte Jener	40983427	Abdominal	CMN	[Firma]	
62	Ramirez Campos Nelson	45538473	Acum	CMN	[Firma]	
63	Rodriguez Ciriaco Julio	4250006	OP.	CMN	[Firma]	
64	Alvarado Pineda Suarez	80342097	AY	CMN	[Firma]	
65						
66						
67						
68						
69						
70						
71						
72						
73						
74						
75						
76						
77						
78						
79						
80						

RESPONSABLE DEL REGISTRO

Nombre:

Cargo:

Fecha:

Firma:

FRANKLIN A. MEJIA ACOSTA

ING. SSOMA

Viernes 15 de Febrero 2019

Las bromas pesadas son peligrosas

En épocas antiguas, los caballeros se lanzaban por los caminos a demostrar su valor y fuerza de su brazo. Salían a buscar el peligro, a crear disturbios. Desgraciadamente dentro de las empresas también existen estos caballeros, aunque los antiguos tenían razón para hacer eso, ya que buscaban un mundo mejor. Y los de las empresas a los que me quiero referir, solo lo hacen para lograr unas carcajadas.

Y ustedes saben a que clase de tipos me estoy refiriendo. Para lograr una carcajada de sus compañeros o ganarse una sonrisa de una chica se harán los tontos o tratarán de poner a otro en ridículo.

Se usa mucho molestar a los recién entrados. Se les suele hacer bromas por ser novatos. Casi todo hombre instalado en su trabajo está un poco confuso, todo es nuevo y raro para él, es fácil ridiculizarlo. Es el momento en donde necesita una mano que lo guíe, alguien que lo ayude.

Por ejemplo hay quienes gozan quitándoles el asiento a sus compañeros, y esto es muy peligroso, ya que no solo puede sufrir un golpe en el extremo inferior de la espalda, sino porque puede causar una reacción de parte del afectado que termine en tragedia para el mal aventurado bromista.

Otros tienen el buen sentido de dejar sus bromas para las horas fuera del trabajo, pero las hacen en los vestuarios, baños, etc. Luchan, se hacen cosquillas, con la mejor intención del mundo de divertirse un poco, pero olvidan que esto puede causar un resbalón, un golpe, que puede resultar en un brazo o una pierna partida. El punto es que en la empresa es todo trabajo y nada de juego, tiene que ser así si queremos que sea algo seguro. Así quedemos los chistes, las bromas pesadas, y los juegos de mano



SISTEMA DE GESTIÓN DE SEGURIDAD Y SALUD EN EL TRABAJO

Código SSOMA-FT-42

Revisión 00

Fecha 20/02/2017

Página 1/1

CONTROL DE ASISTENCIA

OBRA: Mejoramiento y Recuperación de los Servicios del DPA Supe

N° REGISTRO: 000046

DATOS DEL EMPLEADOR

RAZÓN SOCIAL O DENOMINACIÓN SOCIAL	RUC	DOMICILIO (Dirección, distrito, departamento, provincia)	ACTIVIDAD ECONÓMICA	N° DE TRABAJADORES DEL STAFF
Consumo Marítimo del Norte	20802370320	Calle Vizcaya 167 San Luis - Lima	Construcción	15

INDUCCIÓN ENTRENAMIENTO

TIPO DE EVENTO (MARCAR CON X)

SIMULACRO DE EMERGENCIA CHARLA DE INICIO DE JORNADA CAPACITACIÓN OTROS

TEMAS TRATADOS

AMBIENTE DE TRABAJO

FECHA

19/02/2019

HORA DE INICIO

07:15:00 a.m.

TIEMPO DE DURACIÓN

15 MINUTOS

NUMERO DE CONVOCADOS

15

NUMERO DE PARTICIPANTES

14

NOMBRE DEL EXPOSITOR

F. MEJIA

FIRMA DEL EXPOSITOR

NRO.	APELLIDOS Y NOMBRE DE LOS PARTICIPANTES	DNI	AREA	EMPRESA	FIRMA	OBSERVACIONES
1	MORALES VIVANGO, DANIEL JOAQUIN	25535900	RESIDENTE	CMN		
2	VERA GASTAÑEDA, LUIS MIGUEL	42517324	ING ASISTENTE	CMN		
3	MEJIA ACOSTA, FRANKLIN ALFONSO	32762157	ING SSOMA	CMN		
4	MORALES QUIRI, HAROLD ANDREY	70813010	ASISTENTE TEC	CMN		
5	ESCALANTE PEREZ, CHRISTOPHER JOSE	46075491	ING PRODUCCION	CMN		
6	GUADALUPE SANCHEZ, BUENAVENTURA	09000045	ADMINISTRADO	CMN		
7	AQUINO VILCA, JULIO VIDAL	41766901	ALMACENERO	CMN		
8	CRUZ BAZAN, GILBERTO	42509324	CONDUCTOR	CMN		
9	GALINDO VEGA, BRAYAN MICHAEL	72422711	ING CALIDAD	CMN		
10	TRUJILLO AVALOS HENRRY AURELIO	47626241	ALMACENERO	CMN		
11	SANTILLAN QUIROZ, JULIO	19945643	SANITARIO	CMN		
12	LERMO ZUÑIGA, JOSE LUIS	41690575	COORDINADOR	CMN		
13	VELASQUEZ SALAZAR, CARLO MANUEL D	41150240	COORDINADOR	CMN		
14	BARRETO MALIRICIO, RONALD	71263697	PRACTICANTE	CMN		
15	TACO GILLEN, DONATO	43557372	TOPOGRAFO	CMN		
16						
17						
18						
19						

RESPONSABLE DEL REGISTRO

Nombre:

FRANKLIN A. MEJIA ACOSTA

Cargo:

ING. SSOMA

Fecha:

19/02/2019

Firma:



SISTEMA DE GESTIÓN DE SEGURIDAD Y SALUD EN EL TRABAJO

Código SSOMA-FI-42
 Revisión 00
 Fecha 2014/03/17
 Página 1/1

CONTROL DE ASISTENCIA

OBRA: Mejoramiento y Recuperación de los Servicios del DPA Supe

N° REGISTRO:

000045

DATOS DEL EMPLEADOR

RAZÓN SOCIAL O DENOMINACIÓN SOCIAL	RUC	DOMICILIO (Dirección, distrito, departamento, provincia)	ACTIVIDAD ECONÓMICA	N° DE TRABAJADORES EN EL CENTRO LABORAL
Consorcio Marítimo del Norte	20602379320	Calle Vezcaya 187 San Luis - Lima	Construcción	

INDUCCIÓN

ENTRENAMIENTO

TIPO DE EVENTO (MARCAR CON X)

SIMULACRO DE EMERGENCIA

CHARLA DE INICIO DE JORNADA

CAPACITACION

OTROS

TEMAS TRATADOS

AMBIENTE DE TRABAJO

FECHA

19/02/2019

HORA DE INICIO

07:15:00 a.m.

TIEMPO DE DURACIÓN

15 MINUTOS

NUMERO DE CONVOCADOS

53

NUMERO DE PARTICIPANTES

53

NOMBRE DEL EXPOSITOR

F. MEJIA

FIRMA DEL EXPOSITOR

[Handwritten Signature]

	APELLIDOS Y NOMBRE DE LOS PARTICIPANTES	DNI	AREA	EMPRESA	FIRMA	OBSERVACIONES
1	ABAD BULLON, NICOLAS GUIDO	20689783	OPERARIO	CMN	<i>[Signature]</i>	
2	ACOSTA DE LA CRUZ, EFRAIN	32304537	OPERARIO	CMN	<i>[Signature]</i>	
3	ALVAREZ GILVONIC, FELIX RAUL	60633955	OPERARIO	CMN	<i>[Signature]</i>	
4	ALVAREZ GILVONICO, JAVIER	42377270	OFICIAL	CMN	<i>[Signature]</i>	
5	BELTRAN NAVARRO, LUIS RONNY <i>Person</i>	18176037	OPERARIO	CMN	<i>[Signature]</i>	
6	BENITO DE LA CRUZ, VERONICA YAN	72240042	PINTOR	CMN	<i>[Signature]</i>	
7	BENICHE GONZALEZ, NILI	449695058	OPERARIO	CMN	<i>[Signature]</i>	
8	BLAS CERNA MAXIMO TEODORO	15858430	OPERARIO	CMN	R	
9	BLAS CERNA, PALOMINO ALEJANDRO	15948384	OPERARIO	CMN	R	
10	BLAS DOLORES, MAXIMO JACOB	48476798	OPERARIO	CMN	<i>[Signature]</i>	
11	CABELLO BRAVO, SAMUEL CIRO	32730189	OPERARIO	CMN	<i>[Signature]</i>	
12	CALERO RODRIGUEZ, ELISEO URBANO	42236837	PEON	CMN	<i>[Signature]</i>	
13	CELIS ROJAS EDWIN	25209233	MECANICO	CMN	<i>[Signature]</i>	
14	CHURA CUTIFA, SIFRIANO VICTOR	00491322	OFICIAL	CMN	<i>[Signature]</i>	
15	CINEROS BALLONA, MAXIMO ALNIVAR	25799043	FERRERO	CMN	<i>[Signature]</i>	
16	DE LA CRUZ SOTO, FRANKLIN MAY	70930602	PEON	CMN	<i>[Signature]</i>	
17	DE LA CRUZ, ATENCIO, MAXIMO PABLO	21093564	OPERARIO	CMN	<i>[Signature]</i>	
18	DELGADO GUEVA, CRISTIAN	60283814	PEON	CMN	<i>[Signature]</i>	
19	FASABI SHUPINGAHUA, PAUL	75634892	PEON	CMN	<i>[Signature]</i>	
20	FLORES CARO, JUAN	16666419	PINTOR	CMN	<i>[Signature]</i>	

RESPONSABLE DEL REGISTRO

Nombre:

FRANKLIN A. MEJIA ACOSTA

Cargo:

ING. SSOMA

Fecha:

19/02/2019

Firma:

[Handwritten Signature]



SISTEMA DE GESTIÓN DE SEGURIDAD Y SALUD EN EL TRABAJO

CONTROL DE ASISTENCIA

Código SSOMA-FI-42
 Revisión 00
 Fecha 09/02/2017
 Página 1/1

OBRA: Mejoramiento y Recuperación de los Servicios del DPA Supe

N° REGISTRO: 000044

DATOS DEL EMPLEADOR

RAZÓN SOCIAL O DENOMINACIÓN SOCIAL	RUC	DOMICILIO (Dirección, distrito, departamento, provincia)	ACTIVIDAD ECONÓMICA	N° DE TRABAJADORES EN EL CENTRO LABORAL
Consumo (Maritime del Norte)	20802378320	Calle Vizcaya 187 San Luis Lima	Construcción	

INDUCCIÓN
 ENTRENAMIENTO

TIPO DE EVENTO (MARCAR CON X)

SIMULACRO DE EMERGENCIA
 CHARLA DE INICIO DE JORNADA

CAPACITACIÓN
 OTROS

TEMAS TRATADOS

FECHA

HORA DE INICIO 07:15:00 a.m.

TIEMPO DE DURACIÓN 15 MINUTOS

NUMERO DE CONVOCADOS

NUMERO DE PARTICIPANTES

NOMBRE DEL EXPOSITOR

FIRMA DEL EXPOSITOR

F. MEJIA

Nº.	APELLIDOS Y NOMBRE DE LOS PARTICIPANTES	DNI	AREA	EMPRESA	FIRMA	OBSERVACIONES
41	PERALES ZEVALLOS, NOE MAXIMO	44505979	OPERARIO	CMN	<i>[Signature]</i>	
42	FAMIREZ CUEVA, CARLOS DANIEL	72715465	PINTOR	CMN	<i>[Signature]</i>	
43	RIVERA SOTOMAYOR, LUCIANO	10064860	MAESTRO	CMN	<i>[Signature]</i>	
44	SAAVEDRA CORTEZ, RHOLY JHONSTON	42139151	OPERARIO	CMN	<i>[Signature]</i>	
45	SALAS AMAGUEN REITER	40915271	ALBAÑIL	CMN	<i>[Signature]</i>	
46	SANCHEZ LOPEZ, LUIS MIGUEL	44657504	PEON	CMN	<i>[Signature]</i>	
47	SILICHE LAZO, MICHAEL	71360533	OPERARIO	CMN	<i>[Signature]</i>	
48	SOTO JARA, JORGE LUIS	45528371	PEON	CMN	<i>[Signature]</i>	
49	UGARTE VASQUEZ, MANUEL	47345541	PEON	CMN	<i>[Signature]</i>	
50	VALVERDE OSORIO, OBSTAQUIO AGAPE	32703972	OPERADOR G	CMN	<i>[Signature]</i>	
51	VEGA ZURRILLA, WILLIAM KING	40181821	OPERARIO	CMN	<i>[Signature]</i>	
52	MAJOSALVA URIARTE, JENER	40993427	OPERARIO	CMN	<i>[Signature]</i>	
53	RAMIREZ CAMPOS, NELSON	45536473	PEON	CMN	<i>[Signature]</i>	
54	RODRIGUEZ CHIQUES, JULIO	42500016	OPERARIO	CMN	<i>[Signature]</i>	
55	PRINCIPE SUAREZ, HERNAN	50343891	PEON	CMN	<i>[Signature]</i>	
56	ZAPATA PEREZ ELIASBAN	43095111	OP	CMN	<i>[Signature]</i>	
57	ZAPATA PEREZ TEODORO	09578037	OP	CMN	<i>[Signature]</i>	
58	RODRIGUEZ CHUMBES	41942549	OP	CMN	<i>[Signature]</i>	
59						
60						

RESPONSABLE DEL REGISTRO

Nombre:

FRANKLIN A. MEJIA ACOSTA

Cargo:

ING. SSOMA

Fecha:

Firma:

Martes 19 de Febrero 2019

AMBIENTE DE TRABAJO

- 1.- Mantenga siempre el área de trabajo limpia y ordenada.
- 2.- Tome todas las precauciones necesarias para no alterar las condiciones del ambiente de trabajo, evitando provocar humos, calor, escapes de vapor, ruidos polvos o emanaciones innecesarias.
- 3.- Contribuya a eliminar todo escape de líquidos o gases que observe, informando al supervisor sobre toda pérdida.
- 4.- Cuando desarme encofrados de madera, se deben retirar los clavos inmediatamente y luego ordenar dichas maderas.
- 5.- Todas las excavaciones deben ser señalizadas y/o valladas los trabajos en altura también deben ser señalizados en los niveles inferiores.
- 6.- Cuando una excavación ha sido tapada o cuando concluyo un trabajo en altura, inmediatamente deber ser retirado el vallado y/o la señalización.
- 7.- Los vallados y/o señalizaciones deben ser respetados, bajo ninguna circunstancia deben ser removidos por personal ajeno al sector que los coloco.
- 8.- El acopio de materiales dentro de la obra debe ser señalizado, dejando accesos a las áreas de trabajo y permitiendo el libre desplazamiento entre los distintos sectores.
- 9.- Los caminos y senderos peatonales, deben mantenerse libres de obstáculos; por este motivo no debemos depositar residuos ni acopiar materiales en los mismos.
- 10.- Los recipientes para residuos han sido colocados para su comodidad respételos y uselos.
- 11.- La limpieza de la obra es responsabilidad de todos, por eso la limpieza y el orden del área de trabajos es responsabilidad exclusiva de quienes trabajen en la misma; esta es una tarea que se debe realizar en forma continua durante toda la jornada laboral, debemos hacerlo en nuestro propio beneficio y por el de todos nuestros compañeros.



SISTEMA DE GESTIÓN DE SEGURIDAD Y SALUD EN EL TRABAJO

CONTROL DE ASISTENCIA

Código SS-SMA-FI-42

Revisión 03

Fecha 2019/02/17

Página 1/1

OBRA: Mejoramiento y Recuperación de los Servicios del DPA Supe

N° REGISTRO:

DATOS DEL EMPLEADOR

RAZÓN SOCIAL O DENOMINACIÓN SOCIAL	RUC	DOMICILIO (Dirección, distrito, departamento, provincia)	ACTIVIDAD ECONÓMICA	N° DE TRABAJADORES DEL STAFF
Consorcio Marilimo del Norte	20602379320	Calle Vizcaya 187 San Luis - Lima	Construcción	15

TIPO DE EVENTO (MARCAR CON X)

INDUCCIÓN	<input type="checkbox"/>	SIMULACRO DE EMERGENCIA	<input type="checkbox"/>	CAPACITACIÓN	<input type="checkbox"/>
ENTRENAMIENTO	<input type="checkbox"/>	CHARLA DE INICIO DE JORNADA	<input checked="" type="checkbox"/>	OTROS	<input type="checkbox"/>

TEMAS TRATADOS

MANOS DE HERRAMIENTAS

FECHA	21/02/2019	NUMERO DE CONVOCADOS	15
HORA DE INICIO	07:15:00 a.m	NUMERO DE PARTICIPANTES	13
TIEMPO DE DURACIÓN	15 MINUTOS	NOMBRE DEL EXPOSITOR	F. MEJIA
		FIRMA DEL EXPOSITOR	<i>[Firma]</i>

NRO.	APELLIDOS Y NOMBRE DE LOS PARTICIPANTES	DNI	AREA	EMPRESA	FIRMA	OBSERVACIONES
1	MORALES VIVANCO, DANIEL JOAQUIN	25566900	RESIDENTE	CMN	<i>[Firma]</i>	
2	VERA CASTAÑEDA, LUIS MIGUEL	42517924	ING ASISTENTE	CMN	<i>[Firma]</i>	
3	MEJIA ACOSTA, FRANKLIN ALFONSO	2762157	ING SSOMA	CMN	<i>[Firma]</i>	
4	MORALES QUIRI, HAROLD ANDREY	70913003	ASISTENTE TEC	CMN	<i>[Firma]</i>	
5	ECCALANTE PEREZ, CHRISTOPHER JOSE	46075491	ING PRODUCCION	CMN	<i>[Firma]</i>	
6	GUADALUPE SANCHEZ, BUENAVENTURA	09000045	ADMINISTRADO	CMN	<i>[Firma]</i>	
7	AQUINO VILCA, JULIO VIDAL	41768501	ALMACENERO	CMN	<i>[Firma]</i>	
8	CRUZ BAZAN, GILBERTO	49509324	CONDUCTOR	CMN	<i>[Firma]</i>	
9	GALINDO VEGA, BRAYAN MICHAEL	72422711	ING CALIDAD	CMN	<i>[Firma]</i>	
10	TRUJILLO AVALOS HENPRY AURELIO	47626241	ALMACENERO	CMN	<i>[Firma]</i>	
11	SANTILLAN QUIROZ, JULIO	18845643	SANITARIO	CMN	<i>[Firma]</i>	
12	LERMO ZUÑIGA, JOSE LUIS	41030575	COORDINADOR	CMN	<i>[Firma]</i>	
13	VELASQUEZ SALAZAR, CARLO MANUEL D	41190240	COORDINADOR	CMN	<i>[Firma]</i>	
14	BARRETO MAURICIO, RONALD	71263697	FRACCIÓNANTE	CMN	<i>[Firma]</i>	
15	TACO GUILLEN, DONATO	43557372	TOPOGRAFO	CMN	<i>[Firma]</i>	
16						
17						
18						
19						

RESPONSABLE DEL REGISTRO

Nombre:	FRANKLIN A. MEJIA ACOSTA
Cargo:	ING. SSOMA
Fecha:	21/02/2019
Firma:	<i>[Firma]</i>



SISTEMA DE GESTIÓN DE SEGURIDAD Y SALUD EN EL TRABAJO

Código SSOMA-FT-42
 Revisión 00
 Fecha 2009/01/17
 Páginas 1/1

CONTROL DE ASISTENCIA

OBRA: Mejoramiento y Recuperación de los Servicios del DPA Supe

Nº REGISTRO:

DATOS DEL EMPLEADOR

RAZÓN SOCIAL O DENOMINACIÓN SOCIAL	RUC	DOMICILIO (Dirección, distrito, departamento, provincia)	ACTIVIDAD ECONÓMICA	000041 DE TRABAJADORES EN EL CENTRO LABORAL
Consorcio Marítimo del Norte	20502379320	Calle Vicosya 187 San Luis - Lima	Construcción	

TIPO DE EVENTO (MARCAR CON X)

INDUCCIÓN SIMULACRO DE EMERGENCIA CAPACITACIÓN
 ENTRENAMIENTO CHARLA DE INICIO DE JORNADA OTROS

TEMAS TRATADOS

MANGOS DE HERRAMIENTAS

FECHA: 21/02/2019 NUMERO DE CONVOCADOS: 58
 HORA DE INICIO: 07:15:00 a.m. NUMERO DE PARTICIPANTES: 58
 TIEMPO DE DURACIÓN: 15 MINUTOS NOMBRE DEL EXPOSITOR: F. MEJIA
 FIRMA DEL EXPOSITOR: *[Signature]*

	APELLIDOS Y NOMBRE DE LOS PARTICIPANTES	DNI	AREA	EMPRESA	FIRMA	OBSERVACIONES
1	ABAD BULLON, NICOLAS GUIDO	20689793	OPERARIO	CMN	<i>[Signature]</i>	
2	ACOSTA DE LA CRUZ, EFRAIN	32904567	OPERARIO	CMN	<i>[Signature]</i>	
3	ALVAREZ GILVONIO FELIX RAUL	80633355	OPERARIO	CMN	<i>[Signature]</i>	
4	ALVAREZ GILVONIO, JAVIER	42377270	OFICIAL	CMN	<i>[Signature]</i>	
5	BELTRAN NAVARRO, LUIS ROHINY	16176037	OPERARIO	CMN	<i>[Signature]</i>	
6	BENITO DE LA CRUZ, YERSON YAK	72240042	PINTOR	CMN	<i>[Signature]</i>	
7	BERECHE GONZALES, NILI	449895059	OPERARIO	CMN	<i>[Signature]</i>	
8	BLAS CERNA, MAXIMO TEODORO	15856430	OPERARIO	CMN	<i>[Signature]</i>	
9	BLAS CERNA, PALOMINO ALEJANDRO	15846984	OPERARIO	CMN	<i>[Signature]</i>	
10	BLAS DOLORES, MAXIMO JACOB	48476796	OPERARIO	CMN	<i>[Signature]</i>	
11	CABELLO BRAVO, SAMUEL CIRO	32730189	OPERARIO	CMN	<i>[Signature]</i>	
12	CALERO RODRIGUEZ, ELISEO URBANO	42338957	PEON	CMN	<i>[Signature]</i>	
13	CELIS ROLAS EDWIN	26609230	MECANICO	CMN	<i>[Signature]</i>	
14	CHURA CUTIPA, SIRIANO VICTOR	00491322	OFICIAL	CMN	<i>[Signature]</i>	
15	CISNEROS BALLONA, MAXIMO ALNIVAR	25769043	FERRERO	CMN	<i>[Signature]</i>	
16	DE LA CRUZ SOTO, FRANKLIN MAX	70369602	PEON	CMN	<i>[Signature]</i>	
17	DE LA CRUZ, ATENCIO, MAXIMO PABLO	21089564	OPERARIO	CMN	<i>[Signature]</i>	
18	DELGADO CUEVA, CRISTIAN	80263814	PEON	CMN	<i>[Signature]</i>	
19	FASABI SHUPINGA HUA, PALL	78534892	PEON	CMN	<i>[Signature]</i>	
20	FLORES CAPO, JUAN	15866419	PINTOR	CMN	<i>[Signature]</i>	

RESPONSABLE DEL REGISTRO

Nombre: FRANKLIN A. MEJIA ACOSTA
 Cargo: ING. SSOMA
 Fecha: 21/02/2019
 Firma: *[Signature]*



SISTEMA DE GESTIÓN DE SEGURIDAD Y SALUD EN EL TRABAJO

Código SSOMA-FI-42
 Revisión 01
 Fecha 2013/2017
 Página 1/1

CONTROL DE ASISTENCIA

OBRA: Mejoramiento y Recuperación de los Servicios del DPA Supe

N° REGISTRO: 240

DATOS DEL EMPLEADOR

RAZÓN SOCIAL O DENOMINACIÓN SOCIAL	RUC	DOMICILIO (Dirección, distrito, departamento, provincia)	ACTIVIDAD ECONÓMICA	N° DE TRABAJADORES EN EL CENTRO LABORAL
Consercio Marítimo del Norte	20602379320	Calle Viraya 187 San Lus - Lima	Construcción	

TIPO DE EVENTO (MARCAR CON X)

INDUCCIÓN <input type="checkbox"/>	SIMULACRO DE EMERGENCIA <input type="checkbox"/>	CAPACITACIÓN <input type="checkbox"/>
ENTRENAMIENTO <input type="checkbox"/>	CHARLA DE INICIO DE JORNADA <input type="checkbox"/>	OTROS <input type="checkbox"/>

TEMAS TRATADOS

FECHA	NÚMERO DE CONVOCADOS	_____
HORA DE INICIO 07:15 CO a m	NÚMERO DE PARTICIPANTES	_____
TIEMPO DE DURACIÓN 15 MINUTOS	NOMBRE DEL EXPOSITOR	F MEJÍA
	FIRMA DEL EXPOSITOR	_____

NRO.	APELLIDOS Y NOMBRE DE LOS PARTICIPANTES	DNI	AREA	EMPRESA	FIRMA	OBSERVACIONES
21	FLORE PARIONA, JANS EDU	70291866	PEON	CMN		
22	GARCIA CASIMIRO, GUIDO	06957676	OPERARIO	CMN		
23	GASPAR MEZA AURELIO	19942684	OPERARIO	CMN		
24	GASPAR MEZA, JUAN PABLO	19940529	OPERARIO	CMN		
25	GASPAR SALOME, JOSE LUIZ	75509916	OPERARIO	CMN		
26	CENEIROZO FLORES, FIDEL ANGEL	40006626	OPERARIO	CMN		
27	CENEIROZO PAUCAR, MARLOU DEIVI	71537353	PEON	CMN		
28	GONZALES REYES, YONFER	48084141	OPERARIO	CMN		
29	GREGORIO RICRA, GILBERT ELI	42233357	PEON	CMN		
30	HERQUINIO ALVAREZ, GIANMARCO	48103372	PEON	CMN		
31	HERQUINIO ALVAREZ, JUAN ROLANDO	42376272	PINTOR	CMN		
32	HUAMAN SOTOMAYOR, GREGORIO	40016313	OPERARIO	CMN		
33	JAPA FLOPES, JORGE LUIS	42993317	PEON	CMN		
34	MOGOLLON ALBURQUEQUE, CARLOS HECTOR	3674802	OPERARIO	CMN		
35	MONTES GUILLEM, ALBERTO	19632553	OPERARIO	CMN		
36	MORALES PICCOYA, PEDRO	17555912	OPERARIO	CMN		
37	MOYA LOPEZ, WILDER	45177800	PINTOR	CMN		
38	CEREGON TREJO, CRISTIAN RONALD	72535185	PEON	CMN		
39	OLIVOS MACO, CHARLES	41404659	OPERARIO	CMN		
40	ORTIZ CHAHUA, JUAN CARLOS	42635420	PEON	CMN		

RESPONSABLE DEL REGISTRO

Nombre:	FRANKLIN A. MEJIA ACOSTA
Cargo:	ING. SSOMA
Fecha:	
Firma:	



SISTEMA DE GESTIÓN DE SEGURIDAD Y SALUD EN EL TRABAJO

Código SSOMA-FT-42

Revisión 00

Fecha 20/04/2017

Página 1/1

CONTROL DE ASISTENCIA

OBRA: Mejoramiento y Recuperación de los Servicios del DPA Supe

N° REGISTRO:

000039

DATOS DEL EMPLEADOR

RAZÓN SOCIAL O DENOMINACIÓN SOCIAL	RUC	DOMICILIO (Dirección, distrito, departamento, provincia)	ACTIVIDAD ECONÓMICA	N° DE TRABAJADORES EN EL CENTRO LABORAL
Consorcio Marítimo del Norte	20802379320	Calle Vezaya 167 San Luis - Lima	Construcción	

TIPO DE EVENTO (MARCAR CON X)

INDUCCIÓN SIMULACRO DE EMERGENCIA CAPACITACIÓN
 ENTRENAMIENTO CHARLA DE INICIO DE JORNADA OTROS

TEMAS TRATADOS

FECHA _____ NUMERO DE CONVOCADOS _____
 HORA DE INICIO 07:15:00 a.m. NUMERO DE PARTICIPANTES _____
 TIEMPO DE DURACIÓN 15 MINUTOS NOMBRE DEL EXPOSITOR F. MEJIA
 FIRMA DEL EXPOSITOR _____

ID.	APELLIDOS Y NOMBRE DE LOS PARTICIPANTES	DNI	AREA	EMPRESA	FIRMA	OBSERVACIONES
41	PERALES ZEVALLOS, NOE MAXIMO	44505379	OPERARIO	CMN	<i>[Signature]</i>	
42	RAMIREZ CUEVA, CARLOS DANIEL	72715465	PINTOR	CMN	<i>[Signature]</i>	
43	RIVEPA SOTOMAYOR, LUCIANO	10084603	MAESTRO	CMN	<i>[Signature]</i>	
44	SAAVEIRA COPEZ, RHOLY JHONSTON	42139151	OPERARIO	CMN	<i>[Signature]</i>	
45	SALAS AWAGFUEN, RETER	40915271	ALBAÑIL	CMN	<i>[Signature]</i>	
46	SANCHEZ LOPEZ, LUIS MIGUEL	44855504	PEON	CMN	<i>[Signature]</i>	
47	SINCHE LAZO, MICHAEL	71390533	OPERARIO	CMN	<i>[Signature]</i>	
48	SOTO JARA, JORGE LUIS	45526371	PEON	CMN	<i>[Signature]</i>	
49	LIGARTE VASQUEZ, MANUEL	47345541	PEON	CMN	<i>[Signature]</i>	
50	VALVERDE OSORIO, OBSTAQUIO AGAPE	32769372	OPERADOR G	CMN	<i>[Signature]</i>	
51	VEGA ZORRILLA, WILLIAM KING	40181821	OPERARIO	CMN	<i>[Signature]</i>	
52	MANOSALVA URIARTE, JENER	40969427	OPERARIO	CMN	<i>[Signature]</i>	
53	RAMIREZ CAMPOS, NELSON	45538473	PEON	CMN	<i>[Signature]</i>	
54	RODRIGUEZ CHIQUES, JULIO	42500016	OPERARIO	CMN	<i>[Signature]</i>	
55	PRINCIPE SUAREZ HERNAN	80943691	PEON	CMN	<i>[Signature]</i>	
56	Rodriguez Chaves	41942549	CMN	OPERA	<i>[Signature]</i>	
57	Zapata Perez Elisbeth	43095114	OPERA	CMN	<i>[Signature]</i>	
58	Zapata Perez Teodoro	09578037	OPERARIO	CMN	<i>[Signature]</i>	
59	maximo piter Camara Alva	40301597	ope.	CMN	<i>[Signature]</i>	
60	Jose Mendez				<i>[Signature]</i>	

68 Soto Jara Elvis RESPONSABLE DEL REGISTRO CMN *[Signature]*
 Nombre: FRANKLIN A. MEJIA ACOSTA
 Cargo: ING. SSOMA
 Fecha:
 Firma:



SISTEMA DE GESTIÓN DE SEGURIDAD Y SALUD EN EL TRABAJO

Codigo SSOMA-FT-42

Revisión 00

Fecha 2009/01/17

Página 1/3

CONTROL DE ASISTENCIA

N° REGISTRO: 0000038

OBRA: Mejoramiento y Recuperación de los Servicios del DPA Supe

DATOS DEL EMPLEADOR

RAZÓN SOCIAL O DENOMINACIÓN SOCIAL	RUC	DOMICILIO (Dirección, distrito, departamento, provincia)	ACTIVIDAD ECONÓMICA	N° DE TRABAJADORES EN EL CENTRO LABORAL
Consorcio Marítimo del Norte	20602379320	Calle Viscaya 187 San Luis - Lima	Construcción	

TIPO DE EVENTO (MARCAR CON X)

INDUCCIÓN SIMULACRO DE EMERGENCIA CAPACITACIÓN
 ENTRENAMIENTO CHARLA DE INICIO DE JORNADA OTROS

TEMAS TRATADOS

FECHA: _____ NUMERO DE CONVOCADOS: _____
 HORA DE INICIO: 07:15:00 a.m. NUMERO DE PARTICIPANTES: _____
 TIEMPO DE DURACIÓN: 15 MINUTOS NOMBRE DEL EXPOSITOR: F. MEJIA
 FIRMA DEL EXPOSITOR: _____

N°	APELLIDOS Y NOMBRE DE LOS PARTICIPANTES	DNI	AREA	EMPRESA	FIRMA	OBSERVACIONES
61	Flores Fernandez Oscar	43591245	Ficero	C.U.I.P	<i>[Signature]</i>	
62	Chorpa Sotelo Juan	76713419	Acow	CMN	<i>[Signature]</i>	
63						
64						
65						
66						
67						
68						
69						
70						
71						
72						
73						
74						
75						
76						
77						
78						
79						
80						

RESPONSABLE DEL REGISTRO

Nombre: FRANKLIN A. MEJIA ACOSTA
 Cargo: ING. SSOMA
 Fecha: _____
 Firma: _____

Jueves 21 de Febrero 2019

MANGOS DE HERRAMIENTAS

Hoy vamos a hablar de la importancia de mantener los mangos de las herramientas en buenas condiciones. Es posible que algunos de ustedes piensen que no vale la pena hablar de esto, pero voy a demostrarles que es muy importante.

Tomemos por ejemplo un martillo de carpintero. El largo y el peso del mango deberán estar en proporción directa con el peso de la cabeza. La forma y el tamaño deberá ser adecuada para la mano del trabajador, a la vez tendrá que ser suave y sin astillas y posiblemente, lo que es más importante, la cabeza deberá estar bien colocada y ajustada. Cuando todas las cosas están en la forma en que deben estar será fácil utilizar el martillo en la forma correcta. Pero si el mango no es correcto doblará los clavos, golpeará los dedos y se hará menos trabajo.

Generalmente estas herramientas se fabrican, los mangos son los adecuados, el problema se presenta cuando hay que reemplazarlos o cuando se aflojan. Algunos individuos los arreglan rápidamente y luego se quejan que se han aflojado de nuevo o ponen un mango que es demasiado pequeño o muy corto o que no tiene la forma adecuada. En algunos casos hasta hay quien llega a usar un pedazo de caño.

Todo lo que acabamos de decir se aplica también a todos los otros martillos, pero hay una cosa que es muy importante observar en el martillo de los mecánicos. El mango se engrasa mucho, y el mecánico descuidado no presta atención, en cambio el que tiene conciencia de la prevención de accidentes lo mantiene limpio. Muchos de los golpes, dedos machucados o partículas despedidas son las consecuencias de un mango que se resbaló de la mano de un trabajador descuidado.

Muchos de los peligros existentes con el mango de las hachas que están en malas condiciones. Un hacha mantenida en condición excelente es una herramienta de precisión en las manos de un trabajador calificado. Puede cortar el borde exactamente donde lo quiere, pero no podría hacerlo si la herramienta que está utilizando no es la correcta. Nunca deberá pensar en trabajar con un hacha que tenga el mango flojo o partido. En las manos de una persona sin experiencia el hacha es lo mismo que un arma de fuego en las manos de un niño. El trabajador que no tiene experiencia correrá el riesgo de cortarse los pies, los tobillos y algunas veces hasta la rodilla.

El mango de los picos también tiene que ser correcto, uno que esté roto o flojo puede dejar escapar el pico, el cual puede enterrarse en un pie o en un tobillo. El mango de las limas también puede causar algunas lesiones, pero la falta de aquel causará otras más graves. Si el mango no está bien ajustado y se lodeja en la herramienta, puede lesionar al próximo que la use, si no examina la herramienta antes de usarla.

Un análisis minucioso de todas las herramientas que tienen mango llevaría mucho tiempo, pero hay algunos puntos que siempre tienen que tener en cuenta cuando usen este tipo de herramientas. En resumen, lo que quiero decirles es que todas las herramientas merecen que se las trate en la mejor forma posible y se las utilice para el trabajo para el cual han sido diseñadas. Si el mango no es el correcto y no está en buenas condiciones, la herramienta no es apta para el trabajo y no se podrá trabajar con eficiencia. Las herramientas y los mangos en buenas condiciones y su uso correcto pueden significar la diferencia entre hacer el trabajo adecuadamente o tener un accidente.

000036



CONSORCIO MARITIMO DEL NORTE

05. CAPACITACION



SISTEMA DE GESTIÓN DE SEGURIDAD Y SALUD EN EL TRABAJO

Código SSOMA-FI-42

Revisión 00

Fecha 20/03/2017

Página 1/1

CONTROL DE ASISTENCIA

OBRA: Mejoramiento y Recuperación de los Servicios del DPA Supe

N° REGISTRO: 0000

DATOS DEL EMPLEADOR

RAZÓN SOCIAL O DENOMINACIÓN SOCIAL	RUC	DOMICILIO (Dirección, distrito, departamento, provincia)	ACTIVIDAD ECONÓMICA	N° DE TRABAJADORES EN EL CENTRO LABORAL
Consortio Marítimo del Norte	20602378320	Calle Vezcaya 187 San Luis - Lima	Construcción	

TIPO DE EVENTO (MARCAR CON X)

INFORMACIÓN	<input checked="" type="checkbox"/>	SIMULACRO DE EMERGENCIA	<input type="checkbox"/>	CAPACITACIÓN	<input type="checkbox"/>
ENTRENAMIENTO	<input type="checkbox"/>	CHARLA DE INICIO DE JORNADA	<input checked="" type="checkbox"/>	OTROS	<input type="checkbox"/>

TEMAS TRATADOS

PREPARACION Y RESPUESTA ANTE EMERGENCIAS

FECHA	21/02/2019	NUMERO DE CONVOCADOS	53
HORA DE INICIO	7:00 AM	NUMERO DE PARTICIPANTES	53
TIEMPO DE DURACIÓN	2 Horas	NOMBRE DEL EXPOSITOR	F. MEJIA
		FIRMA DEL EXPOSITOR	<i>[Firma]</i>

	APELLIDOS Y NOMBRE DE LOS PARTICIPANTES	DNI	AREA	EMPRESA	FIRMA	OBSERVACIONES
1	ABAD BULLON, NICOLAS GUIDO	20698790	OPERARIO	CMN	<i>[Firma]</i>	
2	ACOSTA DE LA CRUZ, EFRAIN	32004567	OPERARIO	CMN	<i>[Firma]</i>	
3	ALVAREZ GILVONIO, FELIX RAUL	60633955	OPERARIO	CMN	<i>[Firma]</i>	
4	ALVAREZ GILVONIO, JAVIER	42377270	OFICIAL	CMN	<i>[Firma]</i>	
5	BELTRAN NAVARRO, LUIS RONNY	16176097	OPERARIO	CMN	<i>[Firma]</i>	
6	BENITO DE LA CRUZ, YERSON YAK	72240042	PINTOR	CMN	<i>[Firma]</i>	
7	BERECHE GONZALES, NIL	44986059	OPERARIO	CMN	<i>[Firma]</i>	
8	BLAS DOLORES, MAXIMO JACOB	48476798	OPERARIO	CMN	<i>[Firma]</i>	
9	CABELLO BRAVO, SAMUEL CIRO	32730189	OPERARIO	CMN	<i>[Firma]</i>	
10	CALERO RODRIGUEZ, ELISEO URBANO	42236937	PEON	CMN	<i>[Firma]</i>	
11	CELIS FOJAS EDWIN	25809263	MECANICO	CMN	<i>[Firma]</i>	
12	CHURA CUTIPA, SIPRIANO VICTOR	00491322	OFICIAL	CMN	<i>[Firma]</i>	
13	CISNEROS BALLONA, MAXIMO ALNIVAR	25793043	FIERRERO	CMN	<i>[Firma]</i>	
14	DE LA CRUZ SOTO, FRANKLIN MAX	70080602	PEON	CMN	<i>[Firma]</i>	
15	DE LA CRUZ ATENCIO, MAXIMO PAULO	21090584	OPERARIO	CMN	<i>[Firma]</i>	
16	DELGADO CUEVA, CRISTIAN	90369814	PEON	CMN	<i>[Firma]</i>	
17	FASABI SHUPINGAHUA, PAUL	75834692	PEON	CMN	<i>[Firma]</i>	
18	FLORES CARO, JUAN	15666419	PINTOR	CMN	<i>[Firma]</i>	
19	FLORES FARIONA, JANS EDU	70291696	PEON	CMN	<i>[Firma]</i>	
20	GARCIA CASIMIRO, GUIDO	06857676	OPERARIO	CMN	<i>[Firma]</i>	

RESPONSABLE DEL REGISTRO

Nombre:	FRANKLIN A. MEJIA ACOSTA
Cargo:	ING. SSOMA
Fecha:	21/02/2019
Firma:	<i>[Firma]</i>



SISTEMA DE GESTIÓN DE SEGURIDAD Y SALUD EN EL TRABAJO

Edigo SSOMA-FI-42

Revisión 02

Fecha 20/02/2017

Página 01

CONTROL DE ASISTENCIA

0

OBRA: Mejoramiento y Recuperación de los Servicios del DPA Supe

N° REGISTRO:

DATOS DEL EMPLEADOR

RAZÓN SOCIAL O DENOMINACIÓN SOCIAL	RUC	DOMICILIO (Dirección, distrito, departamento, provincia)	ACTIVIDAD ECONÓMICA	N° DE TRABAJADORES EN EL CENTRO LABORAL
Consortio Marítimo del Norte	20802979320	Calle Vizcaya 187 San Luis - Lima	Construcción	

TIPO DE EVENTO (MARCAR CON X)

REDUCCIÓN <input type="checkbox"/>	SIMULADRO DE EMERGENCIA <input type="checkbox"/>	CAPACITACIÓN <input type="checkbox"/>
ENTRENAMIENTO <input type="checkbox"/>	CHARLA DE INICIO DE JORNADA <input type="checkbox"/>	OTROS <input type="checkbox"/>

TEMAS TRATADOS

FECHA

HORA DE INICIO 07:15:00 a.m

TIEMPO DE DURACIÓN 15 MINUTOS

NUMERO DE CONVOCADOS

NUMERO DE PARTICIPANTES

NOMBRE DEL EXPOSITOR

FIRMA DEL EXPOSITOR

F. MEJIA

	APELLIDOS Y NOMBRE DE LOS PARTICIPANTES	DNI	AREA	EMPRESA	FIRMA	OBSERVACIONES
21	GASPAR MEZA, AURELIO	19942664	OPERARIO	CMN		
22	GASPAR MEZA, JUAN PABLO	19940529	OPERARIO	CMN		
23	GASPAR SALOME, JOSE LUIZ	75503916	OPERARIO	CMN		
24	GENEBROZO FLORES, FIDEL ANGEL	40006626	OPERARIO	CMN		
25	GONZALES REYES, YONFER	48084141	OPERARIO	CMN		
26	GREGORIO RICRA, GILBERT ELI	42233257	PEON	CMN		
27	HERQUINIO ALVAREZ, GIANMARCÓ	49103372	PEON	CMN		
28	HERQUINIO ALVAREZ, JUAN ROLANDO	42376272	PINTOR	CMN		
29	HUAMAN SOTOMAYOR, GREGORIO	40016313	OPERARIO	CMN		
	JARA FLORES, JORGE LUIS	42693317	PEON	CMN		
31	MANOSALVA URIARTE, JENER	40953427	OPERARIO	CMN		
32	MOGGILLON ALBURQUEQUE, CARLOS HECTOR	3874802	OPERARIO	CMN		
33	MONTES GUILLEN, ALBERTO	19832553	OPERARIO	CMN		
34	MORALES PISCOYA, PEDRO	17555912	OPERARIO	CMN		
35	MOYA LOPEZ, WILDER	45177800	PINTOR	CMN		
36	OBREGON TREJO, CRISTIAN RONALD	72535185	PEON	CMN		
37	OLIVOS MACO, CHARLES	41404659	OPERARIO	CMN		
38	ORTIZ CHAHUA, JUAN CARLOS	42025420	PEON	CMN		
39	PERALES ZEVALLOS, NOE MAXIMO	44505379	OPERARIO	CMN		
40	PRINCIPE SUAREZ, HERNAN	60343391	PEON	CMN		

RESPONSABLE DEL REGISTRO

Nombre:	FRANKLIN A. MEJIA ACOSTA
Cargo:	ING. SSOMA
Fecha:	
Firma:	



SISTEMA DE GESTIÓN DE SEGURIDAD Y SALUD EN EL TRABAJO

Código SSOMA-FT 42

Revisión 00

Fecha 20/03/2017

Página 3/3

CONTROL DE ASISTENCIA

0000313

OBRA: Mejoramiento y Recuperación de los Servicios del DPA Supe

N° REGISTRO:

DATOS DEL EMPLEADOR

RAZÓN SOCIAL O DENOMINACIÓN SOCIAL	RUC	DOMICILIO (Dirección, distrito, departamento, provincia)	ACTIVIDAD ECONÓMICA	N° DE TRABAJADORES EN EL CENTRO LABORAL
Consorcio Marítimo del Norte	20602379320	Calle Vecaya 187 San Luis - Lima	Construcción	

TIPO DE EVENTO (MARCAR CON X)

INDUCCIÓN
ENTRENAMIENTO

SIMULACRO DE EMERGENCIA
CHARLA DE INICIO DE JORNADA

CAPACITACIÓN
OTROS

TEMAS TRATADOS

FECHA

NUMERO DE CONVOCADOS

HORA DE INICIO 07:15:00 a.m

NUMERO DE PARTICIPANTES

TIEMPO DE DURACIÓN 15 MINUTOS

NOMBRE DEL EXPOSITOR

F. MEJIA

FIRMA DEL EXPOSITOR

	APELLIDOS Y NOMBRE DE LOS PARTICIPANTES	DNI	AREA	EMPRESA	FIRMA	OBSERVACIONES
41	RAMIREZ CAMPOS, NELSON	45538473	PEON	CMN		
42	RAMIREZ CUEVA, CARLOS DANIEL	72715465	PINTOR	CMN		
43	RIVERA SOTOMAYOR, LUCIANO	10084863	MAESTRO	CMN		
44	RODRIGUEZ CHIQUES, JULIO	42500016	OPERARIO	CMN		
45	RODRIGUEZ CHUMBES, ARTURO	41842548	OPERARIO	CMN		
46	SAAVEDRA CORTEZ, RHOLY JHONSTON	42139151	OPERARIO	CMN		
47	SALAS AMAGFUEN, REYER	40915271	ALBAÑIL	CMN		
48	SANCHEZ LOPEZ, LUIS MIGUEL	44865504	PEON	CMN		
49	SINCHE LAZO, MICHAEL	71390533	OPERARIO	CMN		
50	SOTO JARA, JORGE LUIS	45528371	PEON	CMN		
51	VIGARTE VASQUEZ, MANUEL	47342541	PEON	CMN		
52	VALVERDE OSORIO, OBSTAQUIO AGAPE	32760872	OPERADOR G	CMN		
53	VEGA ZORRILLA, WILLIAM KING	40181821	OPERARIO	CMN		
54	ZAPATA PEREZ, ELESBAN	43095117	OPERARIO	CMN		
55	ZAPATA PEREZ, TEODORO	09578037	OPERARIO	CMN		
56						
57						
58						
59						
60						

RESPONSABLE DEL REGISTRO

Nombre:

FRANKLIN A. MEJIA ACOSTA

Cargo:

ING. SSOMA

Fecha:

Firma:

000032

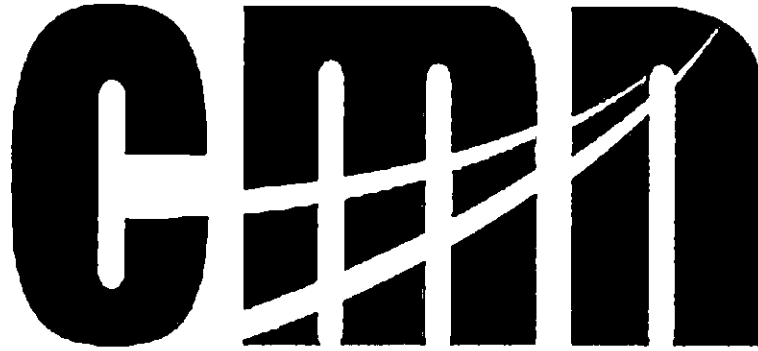

CONSORCIO MARITIMO DEL NORTE

06. AST

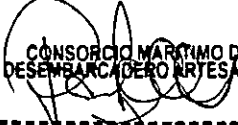
CONSORCIO MARITIMO DEL NORTE
DESEMBARCADERO ARTESANAL DE SUPE

DANIEL JOAQUIN MORALES VIVANCO
RESIDENTE DE OBRA
REG. CIP N° 98098



Tipo de Documento

Código

Fecha

Revisión

HORA:

Proyecto: D. P. A PUERTO SUPA

Nombre de la tarea:

Lampioa tubeno pasar diambre

Personal ejecutante:

Equipos y Herramientas:

Equipos de Protección Individual:

03

Wincha de cablear

Casco fuertes polo guantes

Fecha:

01-02-2019

hoga de sierra comba

havlbiqio corta viento

Ubicación exacta:

zona pto 2do piso

cinel quha calpate

zapato seguridad

Pasos de la tarea:

caballo

resbalones caidas

22 realiza are de

de trabajo

desmonte

trabajo

Verificar las

wincha de cablear

cortes y rasguños

22 usar los epr

herramientas

hoga de sierra

correctos

Señalizar el

area de trabajo

comba cinel

golpes

22 concentracion en

el trabajo

Orden y limpieza

resbalones y caidas

resbalones y caidas

22 orden y limpieza

Pruebas Iniciales:

Trabajo en

Escalera

Trabajos en Altura

Excavaciones

Lotes

Ollas

Ninguna

Nombre del supervisor directo de la tarea:

Armando Arroyo

MATRIZ DE EVALUACION DE RIESGO

SEVERIDAD		1	2	3	4	5	6	7	8	9	10	11	12
Consecuencia	Frecuencia	1	2	3	4	5	6	7	8	9	10	11	12
Menor	Temporal	1	2	3	4	5	6	7	8	9	10	11	12
Medio	Permanente	1	2	3	4	5	6	7	8	9	10	11	12
Mayor	Catastrófica	1	2	3	4	5	6	7	8	9	10	11	12

NIVEL DE RIESGO	DESCRIPCION	BAJO	Medio	Alto
BAJO	Este riesgo puede ser tolerable			
Medio	Este riesgo puede ser tolerable en algunas circunstancias. El riesgo puede ser aceptado si se toman medidas de control.			
Alto	Este riesgo puede ser tolerable en algunas circunstancias. El riesgo puede ser aceptado si se toman medidas de control. El riesgo puede ser aceptado si se toman medidas de control.			
RIESGO	DESCRIPCION			
PLAZO DE CORRECCION				

00000

Firma

Handwritten signatures and initials.



ANÁLISIS DE RIESGO DE LA TAREA

Tipo de Documento
FORMULARIO

Código
APR/PT/23

Fecha
13/09/2017

Revisión
00

HORA: 7:30 - 12:30

Proyecto: DPA SUPE		Nombre de la tarea: ARMADO DE COLUMNAS		Nombre, Apellidos y Firma:		
Personal ejecutante: 11	Equipos y Herramientas: Trozadora, TORTOL, Huincha		Equipos de Protección Individual: Casco, lentes, Tapones Auditivos, Uniforme Completo, Guantes Zapatos punta de Acero		Pedro Morán Puroyn Nili Bereche González M. A. Cisneros Ballón Miguel Ángel Buargueño Obcego Trigo Cristóbal ERIBIN ACOSTA Reiter Santos Arceles Gerardo García	
Fecha: 06-02-2019	Ubicación exacta: CERRO					
Posos de la Tarea		Peligros Identificados		Medidas Preventivas y de Control		
* Verificación del Área de Trabajo		* Caídas a desnivel		* Zonificación del Área de Trabajo		
* Verificación de equipos y Herramientas		* Shock eléctrico		* No utilizar equipos, Herramientas mal estado		
* Habilitación de Material		* Proyección de partículas, Ruidos		* Utilizar todos los EPPS adecuados		
* Acarreo de Material		* Mala Fuerza		* NO cargar Mas peso de lo adecuado		
* colocación de Material		* Cortes, Golpes		* concentración en el Trabajo		
* Fin de la Jornada		* Tropezones, caídas		* ORDEN y LIMPIEZA		
Permisos Requeridos:		<input type="checkbox"/> Trabajo en Caliente <input type="checkbox"/> Espacio Confinado <input type="checkbox"/> Trabajo en Altura <input type="checkbox"/> Excavaciones <input type="checkbox"/> Izaje <input type="checkbox"/> Orca <input type="checkbox"/> Ninguno		Nombre del supervisor directo de la tarea: MORANO RIVERA		
Observaciones:				H. For Filma 000030		

MATRIZ DE EVALUACION DE RIESGO

SEVERIDAD		FRECUENCIA				
		A	B	C	D	E
Catastrófico	1					11
Fatalidad	2					12
Permanente	3		9	13		
Temporal	4	10	14			
Menor	5	15				
		A Común	B Ha sucedido	C Podría suceder	D Rara que sucede	E Prácticamente imposible que suceda

NIVEL DE RIESGO	DESCRIPCIÓN	PLAZO DE CORRECCION
ALTO	Riesgo intolerable, requiere controles inmediatos. Si no se puede controlar PELIGRO se paraliza los trabajos	0 - 24 horas
MEDIO	Iniciar medidas para eliminar o reducir el riesgo. Evaluar si la acción se puede ejecutar de manera inmediata	0 - 72 horas
BAJO	Este riesgo puede ser tolerable	1 mes



Proyecto: **Mantenimiento - Puerto Supe** Nombre de la tarea:

Personal ejecutante: **9** Equipos y Herramientas: **Amoladora, fretador, planas, engrasador, brochas, trillos** Equipos de Protección Individual: **Levas, casco, zapatos, guantes de seguridad**

Fecha: **08/02/19**

Ubicación exacta: **Areas previas**

Pasos de la Tarea	Peligros Identificados	Riesgos Potenciales	Exposición de Riesgo	Medidas Preventivas y/o de Control
1) Inspección del Area de Trabajo	Pisos a desmoronarse, Listrillos, desperdicios en el suelo	golpeado por ladrillos caídos al caminar sobre desperdicios	20	orden y limpieza en el lugar de trabajo
2) Traslado de herramientas y materiales	Tropiezo con arcos de obra, cables, engrasador, brochas	golpeado por herramientas, cables, sus bobinas, planchas de plomo	16	Traslado de equipos entre dos personas
3) Trazado de placas en areas previas	Cemento, arena, agua, trillos, etc.	contacto con el cemento, quemaduras de piel, irritación ojos.	11	Uso de ropa adecuada personal, guantes de látex y
4) orden y limpieza				

Permisos Requeridos: Trabajo en Caliente Espacio Confinado Trabajo en Altura Excavaciones Izaje Otros Noque

Observaciones:

Nombre del supervisor directo de la tarea: **Juliano Rivera**

HORA:
 Nombre, Apellidos y Firma:
 Franklin May De la Cruz S.A.
 Maximo Pabo De la Cruz
 Juan Flores Pariona
 Maximo De la Cruz A
 Abel Ballester Gila
 Rogelio Ballester Ballester
 Marlon Genaboso Pariona
 MICHAEL SANCHE LOPEZ

MATRIZ DE EVALUACION DE RIESGO

SEVERIDAD	I	II	III	IV	V
Catastrófica	1	2	3	4	5
Fatalidad	6	7	8	9	10
Permanente	11	12	13	14	15
Temporal	16	17	18	19	20
Menor	21	22	23	24	25

A B C D E
 Cumán Ha sucedido Podría suceder Raro que suceda Prácticamente imposible que suceda

NIVEL DE RIESGO	DESCRIPCION	PLAZO DE CORRECCION
ALTO	Riesgo intolerable, requiere controles inmediatos. Si no se puede controlar, el RIESGO se paraliza el trabajo.	0 - 24 Horas
MEDIO	Indicaciones para disminuir el riesgo. Cuál sea la acción se puede evaluar de manera inmediata.	0 - 72 Horas
BAJO	Este riesgo puede ser tolerable.	1 mes

Juliano Rivera
Maximo Pabo De la Cruz
Juan Flores Pariona

000029

Tipo de Documento		Fecha		Firma	
Código		Fecha		Firma	
ALM-115		12/02/2019		Sanchez Lopez Luis	

Nombre de la tarea:		Equipos y Herramientas:	
Mejoramiento Retorno ABP - 5upc		Equipos de Protección Individual:	
Nombre, Apellidos y Firma:		Ubicación exacta:	
Sanchez Lopez Luis		Escavación de arena	
Fecha:		Personal ejecutante:	
12-02-2019		2	
Retiro Escavadora		Retiro de equipos y Maquinarias:	
Casco, lentes, guantes, zapato,		Inspección de arena	
Barrabuzo, EPP completo		Trabajo	
Retorno Jaque Jose Luis		Requisición de equipos	
Luis		y Maquinarias:	

Pasos de la Tarea	Peligros Identificados	Riesgos Potenciales	Evaluación de riesgo	Medidas Preventivas y de Control	
				Orden y limpieza	Tamaño en equipo
1. Inspección de arena	Caída de arena	Caída de nivel		Orden y limpieza	
2. Retiro de equipos y Maquinarias:	Retiro escavadora	Atarapamiento, fuerte		Tamaño en equipo	
3. Acarreo de Material	SOBRE PESO	Dolores musculares		GARBAR 25 kg.	
4. Equipos	Eliminación de zanja	Salpicadura de líquidos		Ojo de Bloguadores	
5. Escavaciones:	Partículas	Visión		Solares	
6. Fijación de zanja	Material diverso	Tropesones, cortes		Pinchetas, liberas	
7. Eliminación de arena	Exposición	Acceso		Acceso	

Nombre del supervisor directo de la tarea: José María

Fecha: 12/02/2019

MATRIZ DE EVALUACION DE RIESGO

SEVERIDAD	Frecuencia	A	B	C	D	E	Frecuencia	
							Ha ocurrido	Podría ocurrir
1	1	1	1	1	1	1	1	1
2	2	2	2	2	2	2	2	2
3	3	3	3	3	3	3	3	3
4	4	4	4	4	4	4	4	4
5	5	5	5	5	5	5	5	5

NIVEL DE RIESGO	DESCRIPCION	PLAZO DE CORRECCION
ALTO	Riesgo crítico. Iniciar medidas para eliminar el riesgo dentro de 24 horas para los trabajos.	0 - 24 Horas
MEDIO	Riesgo moderado. Debe ejecutarse dentro de 72 horas para evitar la ocurrencia de un accidente.	0 - 72 Horas
BAJO	Riesgo aceptable. Este riesgo puede ser tolerable.	1 Mes

820000

Forma

José María

Luis

12/02/2019



Tipo de Documento
FORMATO

Código
ADM-F1-25

Fecha
12/09/2017

Revisión
00

Proyecto: *mejoramiento - Puerto supe.*

Nombre de la tarea: *Trazado en altura - Exterior*

HORA:

Personal ejecutante:

20

Equipos y Herramientas:

- Arnes. andamios

Equipos de Protección Individual:

EPP. Completo

Fecha:

15-02-19

Ubicación exacta:

Puerto central.

Nombre, Apellidos y Firma:

F. Rael Abrego Gilsonio

Gregorio Rivera Gilbes

Genobioso Pavez Marcelo

Juan Carlos Ortíz Clavero

Carlos Rodriguez eliso

Alfredo Aguilar Hiza

Georgi Solorche Toto

Abad Ballester Gerardo

Juan Carlos JARA

Olivero Mancho

BLAS CAROL MAXIMO

BLAS CAROL Alejandro

BLAS DOLORES Maximo

SANCHEZ LAZO Michael

Hernandez Alvaro Guzman

De la Cruz Soto Franklin

MAXIMO DELACRUZ A

Montes Guillen Alberto

Nombre del supervisor directo de la tarea:

Jesús Rivera

Peso de la Tarea	Peligros Identificados	Riesgos Potenciales	Evaluación del riesgo	Medidas Preventivas y/o de Control
<i>Inspección en el área de trabajo</i>	<i>Desordenado</i>	<i>tripiezas caídas</i>	<i>20</i>	<i>Ordenar todo el área</i>
<i>Inspección de equipos y herramientas</i>	<i>andamios - EPP. herramientas</i>	<i>cortes caídas ades. nivel - contusiones</i>	<i>14</i>	<i>uso de andamios y herramientas en buen estado</i>
<i>trazado Exterior</i>	<i>andamios - altura mortero cemento</i>	<i>caídas a dos niveles y nivel lumbar inhalación de polvo - irritación al piel.</i>	<i>13</i>	<i>uso correcto de arnes, personal especializado en la actividad</i>
<i>Orden y limpieza</i>	<i>polvo. áreas desordenadas</i>	<i>inhalación de polvo caídas.</i>	<i>10</i>	<i>Ordenar el área antes durante y después</i>

Permisos Requeridos:

- Trabajo en Caliente
- Espacio Confinado
- Trabajos en Altura
- Excavaciones
- Izaje
- Otros
- Ninguno

Observaciones:

MATRIZ DE EVALUACIÓN DE RIESGO

SEVERIDAD	FRECÜENCIA				
	1	2	4	7	11
Catastrófico	1	2	4	7	11
Fatalidad	3	5	8	12	16
Permanente	6	9	13	17	20
Temporal	10	14	15	21	25
Menor	15	19	22	23	24

NIVEL DE RIESGO	DESCRIPCIÓN	PLAZO DE CORRECCIÓN
ALTO	Riesgo intolerable, requiere controles inmediatos. Si no se puede controlar PELIGRO se paraliza lo s trabajo s	0 - 24 Horas
MEDIO	Iniciar medidas para eliminar/reducir el riesgo. Evolucionar si la acción se puede ejecutar de manera inmediata	0- 72 Horas
BAJO	Este riesgo puede ser tolerable	1 mes

[Handwritten signatures and notes]

Firma

130000

000020

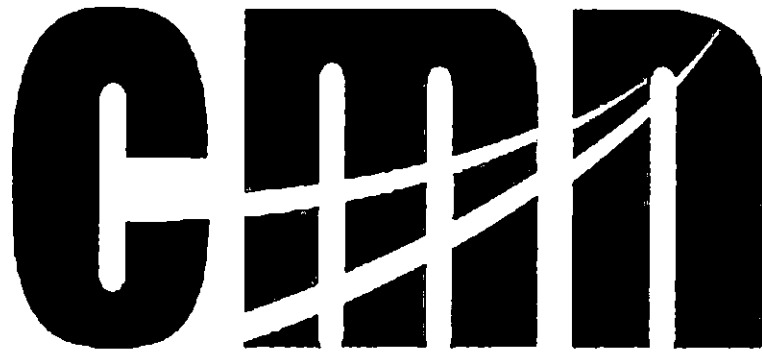

CONSORCIO MARITIMO DEL NORTE

07. PETAR

CONSORCIO MARITIMO DEL NORTE
DESEMBARCADERO ARTESANAL DE SUPE
DANIEL JOAQUIN MORALES VIVANCO
RESIDENTE DE OBRA
REG. CIP N° 98098



PERMISO DE TRABAJO DE ALTO RIESGO (PEJAR) SISTEMA INTEGRADO DE GESTIÓN

Tipo de Documento FORMATO	Código ADM-FT-25	Fecha 01-02-19	Revisión 00
------------------------------	---------------------	-------------------	----------------

ESTÉ PERMISO SE PUEDE UTILIZAR PARA TRABAJOS EN ALTURA, TRABAJOS EN CALIENTE E IZAJE DE CARGAS

1.- DATOS GENERALES

1.2 - LUGAR DE TRABAJO
Area de Administración

1.3 - SUPERVISOR DE PROYECTO

EN LA TAREA
3

1.5 - HORA INICIO
7:30 AM

1.6 - HORA TERMINO

1.7 - FECHA
01-02-19

2 - TIPO DE TRABAJO
ELIGRO CON RELACION AL TRABAJO

3 - RIESGO DE SEGURIDAD

RIESGO CON RELACION AL TRABAJO

- Caídas al mismo nivel
- Caídas a distinto nivel
- Asfixia, respiración dificultosa
- Quemaduras, incendio o amago de incendio
- Electrocuación
- Aprensionamiento/aplastamiento/atrapamiento
- Cortes
- Golpes
- Inhalación de gases de combustión, humos metálicos, etc.
- Otros

DECLARACIÓN DE CONOCIMIENTO PAGINA Nº

Los aquí firmantes declaramos conocer sobre la actividad a realizar y haber sido instruidos sobre el desarrollo seguro de la tarea antes de iniciar el trabajo.

7.- TRABAJADORES AUTORIZADOS

Nº	Nombre	Cargo	Firma
1	Jovenel Benayas Machaca	MY	[Firma]
2	Jose Parales Z	OP	[Firma]
3	JOSE LUIS ROBERTO	OP	[Firma]
4			
5			
6			
7			
8			
9			
10			
11			
12			
13			
14			
15			

4.- EQUIPO DE PROTECCIÓN PERSONAL

Visión	<input checked="" type="checkbox"/> Lentes ploxicorte	<input type="checkbox"/> Careta luna clara	<input checked="" type="checkbox"/> Otros: <input type="checkbox"/>
Industria	<input checked="" type="checkbox"/> Respirador p/polvo	<input checked="" type="checkbox"/> Lunas oscuras	
Impacto	<input checked="" type="checkbox"/> Respirador p/gases	<input type="checkbox"/> Sistema/equipos de izaje	
Protección	<input checked="" type="checkbox"/> Respirador p/pintura	<input type="checkbox"/> Escarpinos	
Protección	<input checked="" type="checkbox"/> Careta para/soldar	<input type="checkbox"/> Mandil de Cuero Cronio	
Protección	<input checked="" type="checkbox"/> Bota Dielec/ Caña alta	<input type="checkbox"/> Guantes de Manobra Caña/Alta	
Protección	<input checked="" type="checkbox"/> Barbiquejo	<input checked="" type="checkbox"/> Extintor	

5.- COMPROBACIONES AL PERSONAL, MATERIALES Y/O EQUIPOS

Etiquetado	<input checked="" type="checkbox"/> Si <input type="checkbox"/> No	Áreas cercanas seguras	<input checked="" type="checkbox"/> Si <input type="checkbox"/> No	Requiere medir %CO2	<input type="checkbox"/> Si <input type="checkbox"/> No
Protección	<input checked="" type="checkbox"/> Si <input type="checkbox"/> No	Vehículo para/maniobras	<input checked="" type="checkbox"/> Si <input type="checkbox"/> No	Deposito de residuos	<input type="checkbox"/> Si <input type="checkbox"/> No
Protección	<input type="checkbox"/> Si <input type="checkbox"/> No	Cuenta de Protección	<input checked="" type="checkbox"/> Si <input type="checkbox"/> No	Otros	<input type="checkbox"/> Si <input type="checkbox"/> No
Protección	<input type="checkbox"/> Si <input type="checkbox"/> No	Colectiva	<input checked="" type="checkbox"/> Si <input type="checkbox"/> No		
Protección	<input checked="" type="checkbox"/> Si <input type="checkbox"/> No	Buen estado de los EPP's	<input checked="" type="checkbox"/> Si <input type="checkbox"/> No		
Protección	<input checked="" type="checkbox"/> Si <input type="checkbox"/> No	Se requiere MSDS	<input type="checkbox"/> Si <input type="checkbox"/> No		

6.- FIRMAS DE AUTORIZACIÓN ANTES DEL INICIO Y AL CIERRE DEL TRABAJO

6.1.- EJECUTANTE DEL TRABAJO	6.2.- MAESTRO DE OBRA	6.3.- SUPERVISOR DE SEGURIDAD
Autorizo a realizar el trabajo bajo condiciones seguras establecidas. Hora: 7:30 AM Firma: [Firma]	He comprobado las condiciones del área y acepto la ejecución del trabajo. Nombre: Luis Rivas Firma: [Firma] Hora: 7:30 AM	Autorizo a realizar el trabajo en las condiciones seguras establecidas. Nombre: [Firma] Firma: [Firma] Hora: 7:30 AM

8.- OBSERVACIONES Y/O SUGERENCIAS

1

2

3

4

5

6

ESTE PERMISO TIENE QUE MANTENERSE EN UN LUGAR VISIBLE, EN EL AREA DE TRABAJO ES UN DOCUMENTO LEGAL AUDITABLE



PERMISO DE TRABAJO DE ALTO RIESGO (PELAR) SISTEMA INTEGRADO DE GESTIÓN

Tipo de Documento FORMATO	Código ADM-FI-25	Fecha	Revisión 00
-------------------------------------	----------------------------	-------	-----------------------

ESTÉ PERMISO SE PUEDE UTILIZAR PARA TRABAJOS EN ALTURA, TRABAJOS EN CALIENTE E IZAJE DE CARGAS

1.- DATOS GENERALES

TRABAJO A REALIZAR: **SE DEBUNDAR**

1.2 - LUGAR DE TRABAJO: **ZONA DE PRIO**

1.3 - SUPERVISOR DE PROYECTO:

1.5 - HORA INICIO: **13:00**

1.6 - HORA TERMINO: **17:00**

1.7 - FECHA: **04.02.2019**

2.- TIPO DE TRABAJO: **PELIGRO CON RELACION AL TRABAJO**

3.- RIESGO DE SEGURIDAD: **RIESGO CON RELACION AL TRABAJO**

Altura	<input checked="" type="checkbox"/>	Caídas al mismo nivel
finado	<input checked="" type="checkbox"/>	Caídas a distinto nivel
Elevada	<input type="checkbox"/>	Asfixia, respiración dificultosa
trincos	<input type="checkbox"/>	Quemaduras, incendio o amago de incendio
cargas	<input type="checkbox"/>	Electrocución
soldadura eléctrica, oxiacorte y/o	<input checked="" type="checkbox"/>	Aplastramiento/aplastamiento/atrapamiento
presencia de gases	<input checked="" type="checkbox"/>	Cortes
nivel (ZANJAS)	<input checked="" type="checkbox"/>	Golpes
	<input type="checkbox"/>	Inhalación de gases de combustión, humos metálicos, etc.
	<input checked="" type="checkbox"/>	Otros

4.- EQUIPO DE PROTECCIÓN PERSONAL

Protección	<input checked="" type="checkbox"/>	Lentes ploxicorte	<input type="checkbox"/>	Careta luna clara	<input type="checkbox"/>	Otros: <input checked="" type="checkbox"/>
Protección	<input checked="" type="checkbox"/>	Respirador p/polvo	<input type="checkbox"/>	Lunas oscuras	<input type="checkbox"/>	
Protección	<input checked="" type="checkbox"/>	Respirador p/gases	<input type="checkbox"/>	Sistema/equipos de izaje	<input type="checkbox"/>	
Protección	<input checked="" type="checkbox"/>	Respirador p/ pintura	<input type="checkbox"/>	Escarpines	<input type="checkbox"/>	
Protección	<input checked="" type="checkbox"/>	Careta para/soldar	<input type="checkbox"/>	Mandil de Cuero Cromo	<input type="checkbox"/>	
Protección	<input checked="" type="checkbox"/>	Bota Dielec/ Caña alta	<input type="checkbox"/>	Guantes de Maniobra Caña Alta	<input type="checkbox"/>	
Protección	<input checked="" type="checkbox"/>	Barbiquejo	<input checked="" type="checkbox"/>	Extintor	<input type="checkbox"/>	

5.- COMPROBACIONES AL PERSONAL, MATERIALES Y/O EQUIPOS

Protección y etiquetado	<input type="checkbox"/>	Áreas cercanas seguras	<input checked="" type="checkbox"/>	Requiere medir %CO2	<input checked="" type="checkbox"/>
Incendio adecuado	<input type="checkbox"/>	Vehículo para/maniobras	<input checked="" type="checkbox"/>	Depósito de residuos	<input checked="" type="checkbox"/>
Quemaduras	<input checked="" type="checkbox"/>	Cuenta c. Protección Colectiva	<input checked="" type="checkbox"/>	Otros	<input type="checkbox"/>
Protección herramientas	<input checked="" type="checkbox"/>	Buen estado de los EPP s	<input checked="" type="checkbox"/>		
		Se requiere MSDS	<input checked="" type="checkbox"/>		

6.- FIRMAS DE AUTORIZACIÓN ANTES DEL INICIO Y AL CIERRE DEL TRABAJO

6.1.- EJECUTANTE DEL TRABAJO	6.2.- MAESTRO DE OBRA	6.3.- SUPERVISOR DE SEGURIDAD
Permiso a realizar el trabajo bajo condiciones seguras establecidas	He comprobado las condiciones del área y acepto la ejecución del trabajo	Autorizo a realizar el trabajo en las condiciones seguras establecidas
Nombre: Alfonso Vega	Nombre: Alfonso Vega	Nombre: F. Campa
Firma: <i>[Signature]</i>	Firma: <i>[Signature]</i>	Firma: <i>[Signature]</i>
Hora: 13:00 pm	Hora: 13:00	Hora: 17:30
Hora:	Hora:	Hora:

DECLARACIÓN DE CONOCIMIENTO PAGINA Nº

Los aquí firmantes declaramos conocer sobre la actividad a realizar y haber sido instruidos sobre el desarrollo seguro de la tarea antes de iniciar el trabajo.

7.- TRABAJADORES AUTORIZADOS

Nº	Nombre	Cargo	Firma
1	SILVANO CRUZ COTIPO.	OR	<i>[Signature]</i>
2	Alfonso Vega	OR	<i>[Signature]</i>
3			
4			
5			
6			
7			
8			
9			
10			
11			
12			
13			
14			
15			

8.- OBSERVACIONES Y/O SUGERENCIAS

1

2

3

4

5

6

ESTE PERMISO TIENE QUE MANTENERSE EN UN LUGAR VISIBLE, EN EL AREA DE TRABAJO ES UN DOCUMENTO LEGAL AUDITABLE

000001



**PERMISO DE TRABAJO DE ALTO RIESGO (PETAR)
SISTEMA INTEGRADO DE GESTIÓN**

Tipo de Documento FORMATO	Código ADM-FT-25	Fecha ..	Revisión 00
-------------------------------------	----------------------------	--------------------	-----------------------

ESTE PERMISO SE PUEDE UTILIZAR PARA TRABAJOS EN ALTURA, TRABAJOS EN CALIENTE E IZAJE DE CARGAS

1.- DATOS GENERALES

1.1 - TRABAJO A REALIZAR: **2000. 20 CISTERNA**

1.2 - LUGAR DE TRABAJO: **ZONA SECTICA**

1.3 - SUPERVISOR DE PROYECTO: _____

15 - HORA INICIO: **7:30**

16 - HORA TERMINO: **12:00**

17 - FECHA: **09/02 2019**

2 - TIPO DE TRABAJO: _____

3 - RIESGO DE SEGURIDAD: _____

3.- RIESGO CON RELACIÓN AL TRABAJO

Los en Altura
no Confinado
Temperatura Elevada
Cables eléctricos
Peso de cargas
Trabajos con soldadura eléctrica, oxicorte y/o
Cilindro
Trabajos con presencia de gases
Trabajos bajo nivel (ZANJAS)

Caidas al mismo nivel
 Caidas a distinto nivel
 Asfixia, respiración dificultosa
 Quemaduras, incendio o riesgo de incendio
 Electrocuación
 Aprisionamiento/aplastamiento/atrapamiento
 Cortes
 Golpes
 Inhalación de gases de combustión, hornos metálicos, etc
 Otros _____

4.- EQUIPO DE PROTECCIÓN PERSONAL

Protección de seguridad contra impacto	<input checked="" type="checkbox"/>	Lentes p/oxicorte	<input type="checkbox"/>	Careta luna clara	<input type="checkbox"/>	Otros: <input type="checkbox"/>
Gafas auditivas u orejeras	<input checked="" type="checkbox"/>	Respirador p/polvo	<input type="checkbox"/>	Lunas oscuras	<input type="checkbox"/>	_____
Calzado apropiado	<input checked="" type="checkbox"/>	Respirador p/gases	<input type="checkbox"/>	Sistema/equipos de izaja	<input type="checkbox"/>	_____
Arneses de vida	<input type="checkbox"/>	Respirador p/ pintura	<input type="checkbox"/>	Escarpinos	<input type="checkbox"/>	_____
Arneses adaptables al casco	<input checked="" type="checkbox"/>	Careta para/soldar	<input type="checkbox"/>	Mandil de Cuero Cromo	<input type="checkbox"/>	_____
		Bota Dielec/ Caña alta	<input type="checkbox"/>	Guantes de Manobra Caña Alta	<input type="checkbox"/>	_____
		Barbiquejo	<input checked="" type="checkbox"/>	Extintor	<input type="checkbox"/>	_____

5.- COMPROBACIONES AL PERSONAL, MATERIALES Y/O EQUIPOS

Etiquetado y bloqueo	<input type="checkbox"/>	Áreas cercanas seguras	<input type="checkbox"/>	Requiere medir %CO2	<input type="checkbox"/>
Extintor adecuado	<input type="checkbox"/>	Vehículo para maniobras	<input type="checkbox"/>	Depósito de residuos	<input type="checkbox"/>
Botiquín	<input type="checkbox"/>	Cuenta c. Protección Colectiva	<input checked="" type="checkbox"/>	Otros	<input type="checkbox"/>
Equipos/herramientas	<input type="checkbox"/>	Buen estado de los EPP's	<input checked="" type="checkbox"/>		
		Se requiere MSDS	<input type="checkbox"/>		

6.- FIRMAS DE AUTORIZACIÓN ANTES DEL INICIO Y AL CIERRE DEL TRABAJO

INGENIERO EJECUTANTE DEL TRABAJO	6.2.- MAESTRO DE OBRA	6.3.- SUPERVISOR DE SEGURIDAD
Autoniza a realizar el trabajo bajo condiciones seguras establecidas	Ha comprobado las condiciones del área y acepta la ejecución del trabajo	Autoniza a realizar el trabajo en las condiciones seguras establecidas
Nombre: [Firma]	Nombre: Diego Rivera	Nombre: F. Mejías
Hora: 7:30 AM	Hora: 7:25	Hora: 7:30
Hora: _____	Hora: _____	Hora: 12:00

DECLARACIÓN DE CONOCIMIENTO PAGINA Nº _____

Los aquí firmantes declaramos conocer sobre la actividad a realizar y haber sido instruidos sobre el desarrollo seguro de la tarea antes de iniciar el trabajo.

7.- TRABAJADORES AUTORIZADOS

Nº	Nombre	Cargo	Firma
1	Artesanos Américo	OP	[Firma]
2	Guido García Casimiro	OP	[Firma]
3	Vega Zornillo Wilmar	OP	[Firma]
4	Ortega José Cristian	OP	[Firma]
5	Errol N. Acosta de la Cruz	OP	[Firma]
6	Miguel Ángel Burgos	OP	[Firma]
7			
8			
9			
10			
11			
12			
13			
14			
15			

8.- OBSERVACIONES Y/O SUGERENCIAS

1 _____

2 _____

3 _____

4 _____

5 _____

6 _____



PERMISO DE TRABAJO DE ALTO RIESGO (PETAR)

SISTEMA INTEGRADO DE GESTIÓN

Tipo de Documento FORMATO	Código ADM-FT-25	Fecha	Revisión 00
------------------------------	---------------------	-------	----------------

ESTE PERMISO SE PUEDE UTILIZAR PARA TRABAJOS EN ALTURA, TRABAJOS EN CALIENTE E IZAJE DE CARGAS

1.- DATOS GENERALES

1.1.- TRABAJO A REALIZAR: *movimiento de tierras*

1.2.- LUGAR DE TRABAJO: *PTA A*

1.3.- SUPERVISOR DE PROYECTO

1.4.- Nº PERSONAS EN LA TAREA: *2*

1.5.- HORA INICIO: *08:00 AM*

1.6.- HORA TERMINO: *05:00 PM*

1.7.- FECHA: *08-02-2019*

2.- TIPO DE TRABAJO

PELIGRO CON RELACIÓN AL TRABAJO

Trabajos en Altura
Espacio Confinado
Temperatura Elevada
Trabajos eléctricos
Izamiento de cargas
Trabajos con soldadura eléctrica, oxiacorte y/o esmerinado
Trabajos con presencia de gases
Trabajos bajo nivel (ZANJAS)
Otros

3.- RIESGO DE SEGURIDAD

RIESGO CON RELACIÓN AL TRABAJO

- Caídas al mismo nivel
- Caídas a distinto nivel
- Asfixia, respiración dificultosa
- Quemaduras, incendio o amago de incendio
- Electrocuación
- Aprisionamiento/aplastamiento/atrapamiento
- Cortes
- Golpes
- Inhalación de gases de combustión, humos metálicos, etc.
- Otros

DECLARACIÓN DE CONOCIMIENTO PAGINA Nº

Los aquí firmantes declaramos conocer sobre la actividad a realizar y haber sido instruidos sobre e seguro de la tarea antes de iniciar el trabajo.

7.- TRABAJADORES AUTORIZADOS

Nº	Nombre	Cargo	
1	<i>Sanchez Lopez Luis</i>	<i>A. y</i>	<i>20</i>
2	<i>Arceano Parano Jose Luis</i>	<i>O.P.</i>	<i>6</i>
3			
4			
5			
6			
7			
8			
9			
10			
11			
12			
13			
14			
15			

4.- EQUIPO DE PROTECCIÓN PERSONAL

casco de protección <input checked="" type="checkbox"/>	Lentes ploxicorte <input checked="" type="checkbox"/>	Careta luna clara <input type="checkbox"/>	Otros: <input type="checkbox"/>
zapato de seguridad <input checked="" type="checkbox"/>	Respirador p/polvo <input checked="" type="checkbox"/>	Lunas oscuras <input type="checkbox"/>	
guantes contra impacto <input checked="" type="checkbox"/>	Respirador p/gases <input checked="" type="checkbox"/>	Sistema/equipos de izaje <input type="checkbox"/>	
tapones auditivos u orejeras <input checked="" type="checkbox"/>	Respirador p/ pintura <input checked="" type="checkbox"/>	Escarpines <input type="checkbox"/>	
guantes apropiados <input checked="" type="checkbox"/>	Careta para/soldar <input checked="" type="checkbox"/>	Mandil de Cuero Cromo <input type="checkbox"/>	
casco línea de vida <input checked="" type="checkbox"/>	Bota Dielec/ Caña alta <input checked="" type="checkbox"/>	Guantes de Manobra Caña Alta <input type="checkbox"/>	
protección Viento adaptable al casco <input checked="" type="checkbox"/>	Barbiquejo <input checked="" type="checkbox"/>	Extintor <input checked="" type="checkbox"/>	

5.- COMPROBACIONES AL PERSONAL, MATERIALES Y/O EQUIPOS

requiere bloqueo y etiquetado <input checked="" type="checkbox"/>	Si No <input type="checkbox"/>	Áreas cercanas seguras <input type="checkbox"/>	Si No <input type="checkbox"/>	Requiere medir %CO2 <input type="checkbox"/>	Si No <input type="checkbox"/>
extintor contra incendio adecuado <input checked="" type="checkbox"/>	<input type="checkbox"/>	Vehículo para/maniobras <input type="checkbox"/>	<input type="checkbox"/>	Depósito de residuos <input type="checkbox"/>	<input type="checkbox"/>
extintor con botiquín <input checked="" type="checkbox"/>	<input type="checkbox"/>	Cuenta c. Protección Colectiva <input type="checkbox"/>	<input type="checkbox"/>	Otros <input type="checkbox"/>	<input type="checkbox"/>
revisión equipos/herramientas <input checked="" type="checkbox"/>	<input type="checkbox"/>	Buen estado de los EPP's <input checked="" type="checkbox"/>	<input type="checkbox"/>		
		Se requiere MSDS <input type="checkbox"/>	<input type="checkbox"/>		

6.- FIRMAS DE AUTORIZACIÓN ANTES DEL INICIO Y AL CIERRE DEL TRABAJO

6.1.- INGENIERO EJECUTANTE DEL TRABAJO	6.2.- MAESTRO DE OBRA	6.3.- SUPERVISOR DE SEGURIDAD
responsabilizo a realizar el trabajo bajo condiciones seguras establecidas	He comprobado las condiciones del área y acepto la ejecución del trabajo	Autorizo a realizar el trabajo en las condiciones seguras establecidas
Nombre: <i>Luis Vero</i>	Nombre: <i>Juan...</i>	Nombre: <i>F. Mejía A.</i>
Firma: <i>[Firma]</i>	Firma: <i>[Firma]</i>	Firma: <i>[Firma]</i>
Hora: <i>8:00</i>	Hora: <i>8:00</i>	Hora: <i>8:00</i>
Hora: <i>5:00</i>	Hora: <i>5:00</i>	Hora: <i>5:00</i>

8.- OBSERVACIONES Y/O SUGERENCIAS

1

2

3

4

5

6

08/02/2019

ESTE PERMISO TIENE QUE MANTENERSE EN UN LUGAR VISIBLE, EN EL AREA DE TRABAJO ES UN DOCUMENTO LEGAL AUDITABLE

ESTE PERMISO SE PUEDE UTILIZAR PARA TRABAJOS EN ALTURA, TRABAJOS EN CALIENTE E IZAJE DE CARGAS

1.- DATOS GENERALES

1.1.- TRABAJO A REALIZAR <i>Picudo y armata de andena</i>		1.2.- LUGAR DE TRABAJO <i>Lugares previos</i>		
1.3.- SUPERVISOR DE PROYECTO				
1.4.- N° PERSONAS EN LA TAREA <i>02</i>	1.5.- HORA INICIO <i>07:00</i>	1.6.- HORA TERMINO <i>5:00</i>	1.7.- FECHA <i>25-02-19</i>	
2.- TIPO DE TRABAJO PELIGRO CON RELACION AL TRABAJO		3.- RIESGO DE SEGURIDAD RIESGO CON RELACION AL TRABAJO		

- | | |
|--|---|
| <input checked="" type="checkbox"/> Trabajos en Altura
<input type="checkbox"/> Espacio Confinado
<input type="checkbox"/> Temperatura Elevada
<input type="checkbox"/> Trabajos eléctricos
<input type="checkbox"/> Izamiento de cargas
<input type="checkbox"/> Trabajos con soldadura eléctrica, oxiacorte y/o esmerilado
<input type="checkbox"/> Trabajos con presencia de gases
<input type="checkbox"/> Trabajos bajo nivel (ZANJAS)
<input type="checkbox"/> Otros | <input checked="" type="checkbox"/> Caídas al mismo nivel
<input checked="" type="checkbox"/> Caídas a distinto nivel
<input type="checkbox"/> Asfalta, respiración dificultosa
<input type="checkbox"/> Quemaduras, incendio o amago de incendio
<input type="checkbox"/> Electrocutación
<input type="checkbox"/> Aprisionamiento/aplastamiento/atrapamiento
<input type="checkbox"/> Cortes
<input checked="" type="checkbox"/> Golpes
<input checked="" type="checkbox"/> Inhalación de gases de combustión, humos metálicos, etc.
<input type="checkbox"/> Otros: |
|--|---|

4.- EQUIPO DE PROTECCIÓN PERSONAL

Casco de protección <input checked="" type="checkbox"/>	Lentes p/oxicorte <input type="checkbox"/>	Carota (luna clara) <input type="checkbox"/>	Otros: <input checked="" type="checkbox"/>
Zapato de seguridad <input checked="" type="checkbox"/>	Respirador p/poivo <input type="checkbox"/>	Lunas oscuras <input type="checkbox"/>	
Lentes contra impacto <input checked="" type="checkbox"/>	Respirador p/gases <input type="checkbox"/>	Sistema/equipos de izaje <input type="checkbox"/>	
Tapones auditivos u orejeras <input checked="" type="checkbox"/>	Respirador p/pintura <input type="checkbox"/>	Escarpinas <input type="checkbox"/>	
Gautes apropiados <input checked="" type="checkbox"/>	Carota para soldar <input checked="" type="checkbox"/>	Mandil de Cuero Cromo <input type="checkbox"/>	
Arnes c/Anco de vida <input checked="" type="checkbox"/>	Bota Dioloci Caña alta <input type="checkbox"/>	Gautes de Manobra Caña Alta <input type="checkbox"/>	
Corta Viento adaptable al casco <input checked="" type="checkbox"/>	Barbiquejo <input checked="" type="checkbox"/>	Extintor <input type="checkbox"/>	

5.- COMPROBACIONES AL PERSONAL, MATERIALES Y/O EQUIPOS

Requiere bloqueo y etiquetado <input type="checkbox"/>	SI No <input type="checkbox"/>	Áreas cercanas seguras <input type="checkbox"/>	SI No <input type="checkbox"/>	Requiere medir %CO2 <input type="checkbox"/>	SI No <input type="checkbox"/>
Equipo contra incendio adecuado <input type="checkbox"/>	<input type="checkbox"/>	Vehículo para maniobras <input type="checkbox"/>	<input type="checkbox"/>	Depósito de residuos <input type="checkbox"/>	<input type="checkbox"/>
Cuenta con botiquín <input checked="" type="checkbox"/>	<input checked="" type="checkbox"/>	Cuenta c/ Protección Colectiva <input checked="" type="checkbox"/>	<input checked="" type="checkbox"/>	Otros <input type="checkbox"/>	<input type="checkbox"/>
Se revisó equipos/herramientas <input checked="" type="checkbox"/>	<input checked="" type="checkbox"/>	Buen estado de los EPP's <input checked="" type="checkbox"/>	<input checked="" type="checkbox"/>		
		Se requiere MSDS <input type="checkbox"/>	<input type="checkbox"/>		

6.- FIRMAS DE AUTORIZACIÓN ANTES DEL INICIO Y AL CIERRE DEL TRABAJO

6.1.- INGENIERO EJECUTANTE DEL TRABAJO		6.2.- MAESTRO DE OBRA		6.3.- SUPERVISOR DE SEGURIDAD	
Me responsabilizo a realizar el trabajo bajo condiciones seguras establecidas		He comprobado las condiciones del área y acepto la ejecución del trabajo		Autorizo a realizar el trabajo en las condiciones seguras establecidas	
Nombre: <i>Carlos J...</i>	Nombre: <i>Juanito Rivero</i>	Nombre: <i>F. Mejía</i>	Nombre: <i>F. Mejía</i>	Nombre: <i>F. Mejía</i>	Nombre: <i>F. Mejía</i>
Firma: <i>[Firma]</i>	Firma: <i>[Firma]</i>	Firma: <i>[Firma]</i>	Firma: <i>[Firma]</i>	Firma: <i>[Firma]</i>	Firma: <i>[Firma]</i>
Hora: <i>7:00</i>	Hora: <i>8:20</i>	Hora: <i>7:30</i>	Hora: <i>7:30</i>	Hora: <i>7:30</i>	Hora: <i>7:30</i>
Firma: <i>[Firma]</i>	Firma: <i>[Firma]</i>	Firma: <i>[Firma]</i>	Firma: <i>[Firma]</i>	Firma: <i>[Firma]</i>	Firma: <i>[Firma]</i>
Hora: <i>[Firma]</i>	Hora: <i>[Firma]</i>	Hora: <i>[Firma]</i>	Hora: <i>[Firma]</i>	Hora: <i>[Firma]</i>	Hora: <i>[Firma]</i>

ESTE PERMISO TIENE QUE MANTENERSE EN UN LUGAR VISIBLE; EN EL AREA DE TRABAJO ES UN DOCUMENTO LEGAL AUDITABLE

DECLARACIÓN DE CONOCIMIENTO PAGINA N°
Los aquí firmantes declaramos conocer sobre la actividad a realizar y haber sido instruidos sobre el desarrollo seguro de la tarea antes de iniciar el trabajo.

7.- TRABAJADORES AUTORIZADOS

N°	Nombre	Cargo	Firma
1	<i>Stony Edwin Jara</i>	<i>[Firma]</i>	<i>[Firma]</i>
2	<i>Plaris Patricia Jara</i>	<i>[Firma]</i>	<i>[Firma]</i>
3	<i>Juan Francisco Alvarez</i>	<i>[Firma]</i>	<i>[Firma]</i>
4	<i>Elseo Cabo Rodriguez</i>	<i>[Firma]</i>	<i>[Firma]</i>
5	<i>Argemiro Alvarez Zamora</i>	<i>[Firma]</i>	<i>[Firma]</i>
6			
7			
8			
9			
10			
11			
12			
13			
14			
15			

8.- OBSERVACIONES Y/O SUGERENCIAS

DEPARTAMENTO DE PREVENCIÓN

000021

000020

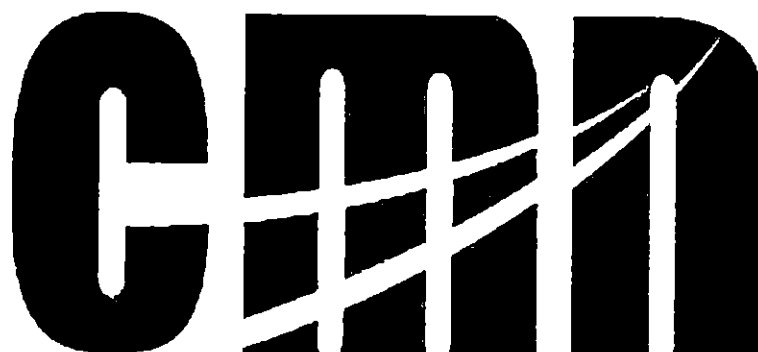

CONSORCIO MARITIMO DEL NORTE

08. CHECK LIST



FORMATO

Código: SSOMA-FT-32
Versión: 00
Fecha: 22/09/2017
Página: 060019

LISTA DE VERIFICACIÓN DE TRONZADORA

Fecha: 03-02-19

DEPARTAMENTO: Supe - Puerta
ÁREA: estructura
CONTRATISTA: CMN
OBRA: Muelle p. Texmal

LUGAR: Supe - Puerta
ACTIVIDAD: Corte
FECHA DE INSPECCIÓN: 03-02-19
OPERADOR: Frank David Celestino

EQUIPO MOVIL

PRE USO (INSPECCION)

EQUIPO FIJO

USO (DURANTE LA ACTIVIDAD)

OPERADOR

IMAGEN CORPORATIVA	BUENO	MALO	NO TIENE	OBSERVACIONES
POLO	RR			
PANTALON	RR			
IMPLEMENTOS DE PROTECCIÓN	BUENO	MALO	NO TIENE	OBSERVACIONES
CASCO	RR			
CARRILLERA CON BARBIQUEJO	RR			
CARETA DE PROTECCION FACIAL	RR			
MASCARILLA PARA POLVO	RR			
GUANTES DE CUERO CAÑA LARGA	RR			
MANDIL DE CUERO	RR			
ESCARPINES DE CUERO	RR			
PROTECTOR AUDITIVO (> 80DB)	RR			
CALZADO DE SEGURIDAD (PUNTERA REFORZADA)	RR			

EQUIPO

PROTECCIONES MECANICAS	BUENO	MALO	NO TIENE	OBSERVACIONES
DISCO DE TRONZAR	RR			
INTERRUPTOR DE CONEXIÓN / DESCONEXION	RR			
EMPUÑADURA	RR			
GUIA DE CORTE	RR			
PLACA BASE	RR			
PERNO DE AJUSTE DE DISCO	RR			
GUARDA FIJA DE DISCO	RR			
GUARDA MOVIL DE DISCO	RR			
CONECTOR JEBE EQUIPO Y CABLE	RR			
CABLE DE ALIMENTACIÓN	RR			
ENCHUFE	RR			
EMPUÑADURA DE TRANSPORTE	RR			
PROTECCION CONTRA CHISPAS	RR			
BLOQUEO DE CONEXIÓN	RR			
LLAVE HEXAGONAL	RR			
TORNILLOS MARIPOSA	RR			
EXPULSOR DE VIRUTAS	RR			
TOPES	RR			

OPERADOR DE TRONZADORA

Capataz

PDR

Queda absolutamente prohibida cualquier modificación del presente documento sin la autorización previa y expresa del Coordinador del SGI

	CHECK LIST DEL VEHICULO		Código: OP-FT-03
	DPTO. DE SEGURIDAD, SALUD Y MEDIO AMBIENTE		Version: 00
			Pág: 01 de 01
LQUIPO	: <u>RETRO ESCAVADORA</u>	PLACA	:
OPERADOR	: <u>Alejandro Pajuelo Jose Luis</u>	RIGGER	: <u>Sanchez Lopez Luis</u>
SUPERVISOR	:	FECHA	: <u>08-02-2019</u>
KM. INICIO	:	KM FINAL	:
KM. TOTAL	:	COMBUSTIBLE	:

MARCAR	CORRECTO	REPARAR	N/A	O
PARA TODO VEHICULO				
<input checked="" type="checkbox"/> ESTADO DE CARROCERIA	<input type="checkbox"/>	<input type="checkbox"/>	<input checked="" type="checkbox"/>	<input type="checkbox"/>
<input checked="" type="checkbox"/> L. ALTA	<input type="checkbox"/>	<input type="checkbox"/>	<input checked="" type="checkbox"/>	<input type="checkbox"/>
<input checked="" type="checkbox"/> L. BAJA	<input type="checkbox"/>	<input type="checkbox"/>	<input checked="" type="checkbox"/>	<input type="checkbox"/>
<input checked="" type="checkbox"/> L. ESTACIONAMIENTO	<input type="checkbox"/>	<input type="checkbox"/>	<input checked="" type="checkbox"/>	<input type="checkbox"/>
<input checked="" type="checkbox"/> L. DIRECCIONALES	<input type="checkbox"/>	<input type="checkbox"/>	<input checked="" type="checkbox"/>	<input type="checkbox"/>
<input checked="" type="checkbox"/> L. NEBLINEROS	<input type="checkbox"/>	<input type="checkbox"/>	<input checked="" type="checkbox"/>	<input type="checkbox"/>
<input checked="" type="checkbox"/> L. EMERGENCIA	<input type="checkbox"/>	<input type="checkbox"/>	<input checked="" type="checkbox"/>	<input type="checkbox"/>
<input checked="" type="checkbox"/> L. RETROCESO	<input type="checkbox"/>	<input type="checkbox"/>	<input checked="" type="checkbox"/>	<input type="checkbox"/>
<input checked="" type="checkbox"/> PERTIGA	<input type="checkbox"/>	<input type="checkbox"/>	<input checked="" type="checkbox"/>	<input type="checkbox"/>
<input checked="" type="checkbox"/> CIRCULINA	<input type="checkbox"/>	<input type="checkbox"/>	<input checked="" type="checkbox"/>	<input type="checkbox"/>
<input checked="" type="checkbox"/> VELOCIMETRO	<input type="checkbox"/>	<input type="checkbox"/>	<input checked="" type="checkbox"/>	<input type="checkbox"/>
<input checked="" type="checkbox"/> TACOMETRO	<input type="checkbox"/>	<input type="checkbox"/>	<input checked="" type="checkbox"/>	<input type="checkbox"/>
<input checked="" type="checkbox"/> TEMPERATURA	<input type="checkbox"/>	<input type="checkbox"/>	<input checked="" type="checkbox"/>	<input type="checkbox"/>
<input checked="" type="checkbox"/> HOROMETRO	<input type="checkbox"/>	<input type="checkbox"/>	<input checked="" type="checkbox"/>	<input type="checkbox"/>
<input checked="" type="checkbox"/> COMBUSTIBLE	<input type="checkbox"/>	<input type="checkbox"/>	<input checked="" type="checkbox"/>	<input type="checkbox"/>
<input checked="" type="checkbox"/> CLAXON	<input type="checkbox"/>	<input type="checkbox"/>	<input checked="" type="checkbox"/>	<input type="checkbox"/>
<input checked="" type="checkbox"/> ALARMA DE RETROCESO	<input type="checkbox"/>	<input type="checkbox"/>	<input checked="" type="checkbox"/>	<input type="checkbox"/>
<input checked="" type="checkbox"/> BATERIA	<input type="checkbox"/>	<input type="checkbox"/>	<input checked="" type="checkbox"/>	<input type="checkbox"/>
<input type="checkbox"/> NIVEL DE ACEITE DE MOTOR	<input type="checkbox"/>	<input type="checkbox"/>	<input checked="" type="checkbox"/>	<input type="checkbox"/>
<input type="checkbox"/> FRENOS	<input type="checkbox"/>	<input type="checkbox"/>	<input checked="" type="checkbox"/>	<input type="checkbox"/>
<input type="checkbox"/> EMBRAGUE	<input type="checkbox"/>	<input type="checkbox"/>	<input checked="" type="checkbox"/>	<input type="checkbox"/>
<input type="checkbox"/> FAJAS	<input type="checkbox"/>	<input type="checkbox"/>	<input checked="" type="checkbox"/>	<input type="checkbox"/>
<input type="checkbox"/> DIRECCIÓN	<input type="checkbox"/>	<input type="checkbox"/>	<input checked="" type="checkbox"/>	<input type="checkbox"/>
<input type="checkbox"/> CUBOS DOBLE TRACCIÓN	<input type="checkbox"/>	<input type="checkbox"/>	<input checked="" type="checkbox"/>	<input type="checkbox"/>
<input type="checkbox"/> FUGAS DE ACEITE	<input type="checkbox"/>	<input type="checkbox"/>	<input checked="" type="checkbox"/>	<input type="checkbox"/>
<input type="checkbox"/> FUGAS DE COMBUSTIBLE	<input type="checkbox"/>	<input type="checkbox"/>	<input checked="" type="checkbox"/>	<input type="checkbox"/>
<input type="checkbox"/> FUGA DE AIRE	<input type="checkbox"/>	<input type="checkbox"/>	<input checked="" type="checkbox"/>	<input type="checkbox"/>
<input type="checkbox"/> LIMPIA PARABRISAS	<input type="checkbox"/>	<input type="checkbox"/>	<input checked="" type="checkbox"/>	<input type="checkbox"/>
<input type="checkbox"/> SUSPENSIÓN	<input type="checkbox"/>	<input type="checkbox"/>	<input checked="" type="checkbox"/>	<input type="checkbox"/>
<input type="checkbox"/> LLANTAS	<input type="checkbox"/>	<input type="checkbox"/>	<input checked="" type="checkbox"/>	<input type="checkbox"/>
<input type="checkbox"/> TOMA FUERZA	<input type="checkbox"/>	<input type="checkbox"/>	<input checked="" type="checkbox"/>	<input type="checkbox"/>
<input type="checkbox"/> ACEITE HIDRAULICO DE TIMON	<input type="checkbox"/>	<input type="checkbox"/>	<input checked="" type="checkbox"/>	<input type="checkbox"/>
<input type="checkbox"/> REFRIGERANTE	<input type="checkbox"/>	<input type="checkbox"/>	<input checked="" type="checkbox"/>	<input type="checkbox"/>
<input type="checkbox"/> ALGUN SONIDO EXTRAÑO	<input type="checkbox"/>	<input type="checkbox"/>	<input checked="" type="checkbox"/>	<input type="checkbox"/>
<input type="checkbox"/> ESPEJOS	<input type="checkbox"/>	<input type="checkbox"/>	<input checked="" type="checkbox"/>	<input type="checkbox"/>
<input type="checkbox"/> LUNAS	<input type="checkbox"/>	<input type="checkbox"/>	<input checked="" type="checkbox"/>	<input type="checkbox"/>
<input type="checkbox"/> CINTURONES DE SEGURIDAD	<input type="checkbox"/>	<input type="checkbox"/>	<input checked="" type="checkbox"/>	<input type="checkbox"/>
<input type="checkbox"/> ASIENTOS	<input type="checkbox"/>	<input type="checkbox"/>	<input checked="" type="checkbox"/>	<input type="checkbox"/>
<input type="checkbox"/> TAPA COMBUSTIBLE	<input type="checkbox"/>	<input type="checkbox"/>	<input checked="" type="checkbox"/>	<input type="checkbox"/>
<input type="checkbox"/> PUERTAS	<input type="checkbox"/>	<input type="checkbox"/>	<input checked="" type="checkbox"/>	<input type="checkbox"/>
<input type="checkbox"/> LINTERNA	<input type="checkbox"/>	<input type="checkbox"/>	<input checked="" type="checkbox"/>	<input type="checkbox"/>
<input type="checkbox"/> CONOS	<input type="checkbox"/>	<input type="checkbox"/>	<input checked="" type="checkbox"/>	<input type="checkbox"/>
<input type="checkbox"/> EXTINTORES	<input type="checkbox"/>	<input type="checkbox"/>	<input checked="" type="checkbox"/>	<input type="checkbox"/>
<input type="checkbox"/> GATA	<input type="checkbox"/>	<input type="checkbox"/>	<input checked="" type="checkbox"/>	<input type="checkbox"/>
<input type="checkbox"/> BOTIQUIN	<input type="checkbox"/>	<input type="checkbox"/>	<input checked="" type="checkbox"/>	<input type="checkbox"/>
<input type="checkbox"/> CABLE DE REMOLQUE	<input type="checkbox"/>	<input type="checkbox"/>	<input checked="" type="checkbox"/>	<input type="checkbox"/>
<input type="checkbox"/> TRIANGULO DE SEGURIDAD	<input type="checkbox"/>	<input type="checkbox"/>	<input checked="" type="checkbox"/>	<input type="checkbox"/>
<input type="checkbox"/> PLACA DE RODAJE	<input type="checkbox"/>	<input type="checkbox"/>	<input checked="" type="checkbox"/>	<input type="checkbox"/>
<input type="checkbox"/> TARJETA DE PROPIEDAD	<input type="checkbox"/>	<input type="checkbox"/>	<input checked="" type="checkbox"/>	<input type="checkbox"/>
<input type="checkbox"/> SOAT	<input type="checkbox"/>	<input type="checkbox"/>	<input checked="" type="checkbox"/>	<input type="checkbox"/>
<input type="checkbox"/> LLAVE DE RUEDAS	<input type="checkbox"/>	<input type="checkbox"/>	<input checked="" type="checkbox"/>	<input type="checkbox"/>
<input type="checkbox"/> ORDEN Y LIMPIEZA	<input type="checkbox"/>	<input type="checkbox"/>	<input checked="" type="checkbox"/>	<input type="checkbox"/>
<input type="checkbox"/> UÑAS DE LAMPON	<input type="checkbox"/>	<input type="checkbox"/>	<input checked="" type="checkbox"/>	<input type="checkbox"/>
<input type="checkbox"/> BOTELLAS HIDRAULICAS	<input type="checkbox"/>	<input type="checkbox"/>	<input checked="" type="checkbox"/>	<input type="checkbox"/>
<input type="checkbox"/> PINES Y BOCINAS	<input type="checkbox"/>	<input type="checkbox"/>	<input checked="" type="checkbox"/>	<input type="checkbox"/>
<input type="checkbox"/> ESTADO DE MANGUERAS	<input type="checkbox"/>	<input type="checkbox"/>	<input checked="" type="checkbox"/>	<input type="checkbox"/>
<input type="checkbox"/> ESLINGAS DE ACERO	<input type="checkbox"/>	<input type="checkbox"/>	<input checked="" type="checkbox"/>	<input type="checkbox"/>
<input type="checkbox"/> ESLINGAS SINTÉTICAS	<input type="checkbox"/>	<input type="checkbox"/>	<input checked="" type="checkbox"/>	<input type="checkbox"/>
<input type="checkbox"/> GRILLETES	<input type="checkbox"/>	<input type="checkbox"/>	<input checked="" type="checkbox"/>	<input type="checkbox"/>
<input type="checkbox"/> SOGAS	<input type="checkbox"/>	<input type="checkbox"/>	<input checked="" type="checkbox"/>	<input type="checkbox"/>

OBSERVACIONES :

FIRMA DE APROBACIÓN PARA EL INICIO DE ACTIVIDADES		V° B°
Operador:	Ing. Residente / Ing. De Campo:	Prevencionista de Riesgos:
Nombre: <u>Alejandro Pajuelo Jose Luis</u>	Nombre: <u>[Firma]</u>	Nombre: <u>F. Mejía D.</u>
Firma: <u>[Firma]</u>	Firma: <u>[Firma]</u>	Firma: <u>[Firma]</u>



FORMATO

Código: SSOMA-FT-32

Versión: 00

Fecha: 22/09/2017

Página: 1 de 1

LISTA DE VERIFICACIÓN DE TRONZADORA

Fecha: 11-02-2019

DEPARTAMENTO: -----

LUGAR: Zona fierro 10

ÁREA: Electricidad

ACTIVIDAD: -----

CONTRATISTA: CMN

FECHA DE INSPECCIÓN: -----

OBRA: D.P.A. super puerta

OPERADOR: -----

 EQUIPO MOVIL EQUIPO FIJO PRE USO (INSPECCION) USO (DURANTE LA ACTIVIDAD)

OPERADOR

IMAGEN CORPORATIVA	BUENO	MALO	NO TIENE	OBSERVACIONES
POLO	X			
PANTALON	X			
IMPLEMENTOS DE PROTECCIÓN	BUENO	MALO	NO TIENE	OBSERVACIONES
CASCO	X			
CARRILLERA CON BARBIQUEJO	X			
CARETA DE PROTECCION FACIAL	X			
MASCARILLA PARA POLVO	X			
GUANTES DE CUERO CAÑA LARGA	X			
MANDIL DE CUERO	X			
ESCARPINES DE CUERO	X			
PROTECTOR AUDITIVO (> 80DB)	X			
CALZADO DE SEGURIDAD (PUNTERA REFORZADA)	X			

EQUIPO

PROTECCIONES MECANICAS	BUENO	MALO	NO TIENE	OBSERVACIONES
DISCO DE TRONZAR	X			
INTERRUPTOR DE CONEXIÓN / DESCONEXION	X			
EMPUÑADURA	X			
GUIA DE CORTE	X			
PLACA BASE	X			
PERNO DE AJUSTE DE DISCO	X			
GUARDA FIJA DE DISCO	X			
GUARDA MOVIL DE DISCO	X			
CONECTOR JEBE EQUIPO Y CABLE	X			
CABLE DE ALIMENTACIÓN	X			
ENCHUFE	X			
EMPUÑADURA DE TRANSPORTE	X			
PROTECCION CONTRA CHISPAS	X			
BLOQUEO DE CONEXIÓN	X			
LLAVE HEXAGONAL	X			
TORNILLOS MARIPOSA	X			
EXPULSOR DE VIRUTAS	X			
TOPES	X			

OPERADOR DE TRONZADORA

Capataz

PDR

000026



CHECK LIST DEL VEHICULO

Código: OP-FT-03

Version: 00

DPTO. DE SEGURIDAD, SALUD Y MEDIO AMBIENTE

Pág: 01 de 01

EQUIPO : Retiro excavadora Cat. PLACA : _____
 OPERADOR : Arellano PAVULO JOSE LUIS RIGGER : SANCHEZ LOPEZ Luis
 SUPERVISOR : _____ FECHA : 14-02-2019
 KM. INICIO : _____ KM FINAL : _____
 KM. TOTAL : _____ COMBUSTIBLE : _____

MARCAR : CORRECTO REPARAR N/A O

PARA TODO VEHICULO

- | | | |
|--|--|---|
| <input checked="" type="checkbox"/> ESTADO DE CARROCERIA | <input checked="" type="checkbox"/> NIVEL DE ACEITE DE MOTOR | <input checked="" type="checkbox"/> CINTURONES DE SEGURIDAD |
| <input checked="" type="checkbox"/> L. ALTA | <input checked="" type="checkbox"/> FRENO | <input checked="" type="checkbox"/> ASIENTOS |
| <input checked="" type="checkbox"/> L. BAJA | <input checked="" type="checkbox"/> EMBRAGUE | <input checked="" type="checkbox"/> TAPA COMBUSTIBLE |
| <input checked="" type="checkbox"/> L. ESTACIONAMIENTO | <input checked="" type="checkbox"/> FAJAS | <input checked="" type="checkbox"/> PUERTAS |
| <input checked="" type="checkbox"/> L. DIRECCIONALES | <input checked="" type="checkbox"/> DIRECCION | <input checked="" type="checkbox"/> LINTERNA |
| <input checked="" type="checkbox"/> L. NEBLINEROS | <input checked="" type="checkbox"/> CUBOS DOBLE TRACCION | <input checked="" type="checkbox"/> CONOS |
| <input checked="" type="checkbox"/> L. EMERGENCIA | <input checked="" type="checkbox"/> FUGAS DE ACEITE | <input checked="" type="checkbox"/> EXTINTORES |
| <input checked="" type="checkbox"/> L. RETROCESO | <input checked="" type="checkbox"/> FUGAS DE COMBUSTIBLE | <input checked="" type="checkbox"/> GATA |
| <input checked="" type="checkbox"/> FERTIGA | <input checked="" type="checkbox"/> FUGA DE AIRE | <input checked="" type="checkbox"/> BOTIQUIN |
| <input checked="" type="checkbox"/> CIRCULINA | <input checked="" type="checkbox"/> LIMPIA PARABRISAS | <input checked="" type="checkbox"/> CABLE DE REMOLQUE |
| <input checked="" type="checkbox"/> VELOCIMETRO | <input checked="" type="checkbox"/> SUSPENSION | <input checked="" type="checkbox"/> TRIANGULO DE SEGURIDAD |
| <input checked="" type="checkbox"/> TACOMETRO | <input checked="" type="checkbox"/> LLANTAS | <input checked="" type="checkbox"/> PLACA DE RODAJE |
| <input checked="" type="checkbox"/> TEMPERATURA | <input checked="" type="checkbox"/> TOMA FUERZA | <input checked="" type="checkbox"/> TARJETA DE PROPIEDAD |
| <input checked="" type="checkbox"/> HOROMETRO | <input checked="" type="checkbox"/> ACEITE HIDRAULICO DE TIMON | <input checked="" type="checkbox"/> SOAT |
| <input checked="" type="checkbox"/> COMBUSTIBLE | <input checked="" type="checkbox"/> REFRIGERANTE | <input checked="" type="checkbox"/> LLAVE DE RUEDAS |
| <input checked="" type="checkbox"/> CLAXON | <input checked="" type="checkbox"/> ALGUN SONIDO EXTRAÑO | <input checked="" type="checkbox"/> ORDEN Y LIMPIEZA |
| <input checked="" type="checkbox"/> ALARMA DE RETROCESO | <input checked="" type="checkbox"/> ESPEJOS | <input type="checkbox"/> |
| <input checked="" type="checkbox"/> BATERIA | <input checked="" type="checkbox"/> LUNAS | <input type="checkbox"/> |

MAQUINARIA HIDRAULICA (GRUAS, RETROEXCAVADORAS, etc.)

- | | |
|--|--|
| <input type="checkbox"/> NIVEL DE ACEITE HIDRAULICO | <input checked="" type="checkbox"/> UÑAS DE LAMPON |
| <input type="checkbox"/> CHEQUEO DE MANDOS | <input checked="" type="checkbox"/> BOTELLAS HIDRAULICAS |
| <input type="checkbox"/> PLUMA | <input checked="" type="checkbox"/> PINES Y BOBINAS |
| <input checked="" type="checkbox"/> GANCHOS DE GRUA PARA IZAJE | <input checked="" type="checkbox"/> ESTADO DE MANGUERAS |
| <input checked="" type="checkbox"/> GATA DE ESTABILIZADORES | <input type="checkbox"/> ESLINGAS DE ACERO |
| <input checked="" type="checkbox"/> TACOS PARA ESTABILIZADORES | <input type="checkbox"/> ESLINGAS SINTETICAS |
| <input checked="" type="checkbox"/> CUÑAS PARA LLANTAS | <input type="checkbox"/> GRILLETES |
| <input type="checkbox"/> TORNAMESA | <input type="checkbox"/> SOGAS |
| <input checked="" type="checkbox"/> CUCHARA | |

OBSERVACIONES :

FIRMA DE APROBACION PARA EL INICIO DE ACTIVIDADES

V° B°

Operador: ARELLANO PAVULO
 Nombre: JOSE LUIS
 Firma:

Ing. Residente / Ing. De Campo:
 Nombre: [Signature]
 Firma:

Prevencionista de Riesgos:
 Nombre: F. Mejia
 Firma:

	FORMATO	Código: SSOMA-FT-40 Versión: 00 Fecha: 22/09/2017 Página: 1 de 1
LISTA DE VERIFICACION DE AMOLADORA		

Operador: _____

Fecha: 19/02/19

DEPARTAMENTO: <i>Repuestos</i>	LUGAR: _____
AREA: <i>Deposito</i>	ACTIVIDAD: _____
CONTRATISTA: <i>Caro</i>	FECHA DE INSPECCION: 19/02/19
OBRA: <i>Reparación de eje</i>	ORDEN DE TRABAJO: _____

EQUIPO MOVIL
 PRE USO (INSPECCION)

EQUIPO FIJO
 USO (DURANTE LA ACTIVIDAD)

OPERADOR				
P	BUENO	MALO	NO TIENE	OBSERVACIONES
POLO	///			
PANTALON				
IMPLEMENTOS DE PROTECCION				
	BUENO	MALO	NO TIENE	OBSERVACIONES
CASCO	///			/
BARBIQUEJO Y CARRILERA	///			
CARETA	///			
MASCARILLA PARA POLVO 8210	///			
GUANTES LMANOS DE BADANA DE CUERO	///			
PROTECTOR AUDITIVO (> 80DB)	///			

EQUIPO				
PROTECCIONES MECANICAS	BUENO	MALO	NO TIENE	OBSERVACIONES
DISCO DE CORTE	///			/
DISCO DE DESBASTE	///			
PERNO DE AJUSTE DE DISCO	///			
INTERRUPTOR ON-OFF	///			
EMPUÑADURAS O MANGO SOPORTE	///			
LLAVE DE AJUSTE DEL DISCO	///			
PERNO DE AJUSTE DE DISCO	///			
GUARDA DE DISCO	///			
CONECTOR JEBE EQUIPO Y CABLE	///			
PROTECTOR DEL DISCO	///			
CABLE DE ALIMENTACIÓN	///			
ENCHUFE	///			

Capataz / Lider de Campo

Ing. Residente / Campo

Previsionista de Riesgos



CONSORCIO MARITIMO DEL NORTE

09. INSPECCIONES

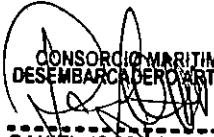
CONSORCIO MARITIMO DEL NORTE
DESEMBARCADERO ARTESANAL DE SUPE

DANIEL JOAQUIN MORALES VIVANCO
RESIDENTE DE OBRA
REG. CIP N° 98098



PROGRAMA DE INSPECCIÓN / CHEQUEO INSTALACIONES

SISTEMA INTEGRADO DE GESTIÓN

Tipo de Documento FORMATO	Código SSOMA-FT-12	Fecha 20/09/2017	Revisión 00
------------------------------	-----------------------	---------------------	----------------

RESPONSABLE:

Franklin Mejía Costa

FECHA:

22/02/2019

PERIODICIDAD DE VERIFICACIÓN:

MENSUAL

Requisitos definidos por la organización	Supervisión		Consortio		SSOMA		Ingeniería		Almacén		Servicios de Bienestar		Comedor		Observaciones	Acciones
	Verificación		Verificación		Verificación		Verificación		Verificación		Verificación		Verificación			
	Cumple	No Cumple	Cumple	No Cumple	Cumple	No Cumple	Cumple	No Cumple	Cumple	No Cumple	Cumple	No Cumple	Cumple	No Cumple		
Los muebles y enseres se encuentran limpios y en buen estado de mantenimiento	✓		✓		✓		✓		✓		✓		✓			
Las instalaciones eléctricas, sanitarias y de comunicaciones se encuentran aisladas y protegidas	✓		✓		✓		✓		✓		✓		✓			
Los Equipos y/o Máquinas (Computo, Impresoras, fax, teléfono, etc) se encuentran operativos.	✓		✓		✓		✓		✓		✓		✓			
Los SSHH se encuentran operativos y en buen estado de mantenimiento	✓		✓		✓		✓		✓		✓		✓			
Existe cantidad suficiente de SSHH acorde al personal que labora en dicha área	✓		✓		✓		✓		✓		✓		✓			
No se observa almacenamiento de materiales en deshuso	✓		✓		✓		✓		✓		✓		✓			
Las zonas de tránsito se encuentran libres de obstáculos	✓		✓		✓		✓		✓		✓		✓			
Las conexiones eléctricas mantienen su aislamiento en todo el recorrido. No se observa cables sueltos	✓		✓		✓		✓		✓		✓		✓			
Los trabajos de mantenimiento se realiza por personal capacitado.	✓		✓		✓		✓		✓		✓		✓			

000018



PROGRAMA DE INSPECCIÓN / CHEQUEO DE INSTALACIONES
SISTEMA INTEGRADO DE GESTIÓN

Tipo de Documento	Código	Fecha	Revisión
FORMATO	SSOMA-FT-12	20/09/2017	00

RESPONSABLE:	<i>Franklin Mejía Costa</i>
PERIODICIDAD DE VERIFICACIÓN:	MENSUAL

FECHA: 22/02/2019

Requisitos definidos por la organización	Supervisión		Consercio		SSOMA		Ingeniería		Almacén		Servicios de Bienestar		Comedor		Observaciones	Acciones
	Verificación		Verificación		Verificación		Verificación		Verificación		Verificación		Verificación			
	Cumple	No Cumple	Cumple	No Cumple	Cumple	No Cumple	Cumple	No Cumple	Cumple	No Cumple	Cumple	No Cumple	Cumple	No Cumple		
Los equipos y/o máquinas, dispositivos eléctricos y tomacorrientes se encuentran en buen estado de mantenimiento, disponen de una adecuada protección para las condiciones de utilización.	✓		✓		✓		✓		✓		✓		✓			
Existen extintores en número suficiente, distribución correcta y de la eficacia requerida	✓		✓		✓		✓		✓		✓		✓			
Los trabajadores están capacitados en el uso de los extintores	✓		✓		✓		✓		✓		✓		✓			
Existe adecuada señalización para facilitar la salida al exterior en caso de emergencia	✓		✓		✓		✓		✓		✓		✓			
Cuentan con un cronograma de mantenimiento y recarga de extintores	✓		✓		✓		✓		✓		✓		✓			
Son correctas las características de los pisos, paredes y techos (lisos y de fácil limpieza). Se mantienen limpios y en buen estado de conservación	✓		✓		✓		✓		✓		✓		✓			000012



PROGRAMA DE INSPECCIÓN / CHEQUEO DE INSTALACIONES
SISTEMA INTEGRADO DE GESTIÓN

Tipo de Documento FORMATO	Código SSOMA-FT-12	Fecha 20/09/2017	Revisión 00
------------------------------	-----------------------	---------------------	----------------

RESPONSABLE: Franklin Mepic Acosta
 PERIODICIDAD DE VERIFICACIÓN: MENSUAL

FECHA: 22/02/2019

Requisitos definidos por la organización	Supervisión		Consortio		SSOMA		Ingeniería		Almacén		Servicios de Bienestar		Comedor		Observaciones	Acciones
	Verificación		Verificación		Verificación		Verificación		Verificación		Verificación		Verificación			
	Cumple	No Cumple	Cumple	No Cumple	Cumple	No Cumple	Cumple	No Cumple	Cumple	No Cumple	Cumple	No Cumple	Cumple	No Cumple		
En el área de almacén cuenta con un lugar para productos no conformes, se encuentra señalizado	✓		✓		✓		✓		✓		✓		✓			
En el área de almacén se respetan los criterios de almacenaje (cant. máx. de apilamiento)	✓		✓		✓		✓		✓		✓		✓			
Existe una adecuada iluminación y ventilación de tal forma que permite realizar las labores de trabajo de forma adecuada	✓		✓		✓		✓		✓		✓		✓			
¿Los muebles y equipos de trabajo son óptimos para el desenvolvimiento del personal?	✓		✓		✓		✓		✓		✓		✓			
¿los sillas de las áreas de oficina brindan una buena posición ergonómica para las personas sentadas en ellas?	✓		✓		✓		✓		✓		✓		✓			000011

000010



CHECKLIST DE CONTROL DEL BOTIQUIN

SISTEMA INTEGRADO DE GESTIÓN

Tipo de Documento

FORMATO

Código

SSOMA-FT-10

Fecha

20/09/2017

Revisión

00

FECHA (DD/MM/AA)

22 1 02 12019

OFICINA

CANT.	MATERIAL DE CURACIÓN Y APOYO	EXISTENCIA	REPOSICIÓN	FECHA DE VENC.	OBSERVACIONES
2	Paquetes de guantes quirúrgicos	✓		2020	
1	Frasco de yodopovidoma 120 ml solución antiséptico	✓		2020	
1	Frasco de agua oxigenada mediano 120 ml	✓		2020	
1	Frasco de alcohol mediano 250 ml	✓		2020	
5	Paquetes de gasas esterilizadas de 10 cm X 10 cm	✓		2020	
8	Paquetes de apósitos	✓		2020	
1	Rollo de esparadrado 5 cm X 4,50 m	✓		2020	
2	Rollos de venda elástica de 3 pulg. X 5 yardas	✓		2020	
2	Rollos de venda elástica de 4 pulg. X 5 yardas	✓		2020	
1	Paquete de algodón x 100 g	✓		2020	
1	Venda triangular	✓		2020	
10	Paletas baja lengua (para entablillado de dedos)	✓		2020	
1	Frasco de solución de cloruro de sodio al 9/1000 x 1 l (para lavado de heridas)	✓		2020	
2	Paquetes de gasa tipo jelonet (para quemaduras)	✓		2020	
2	Frascos de colirio de 10 ml	✓		2020	
1	Tijera punta roma	✓		—	
1	Pinza	✓		—	

ELEMENTOS DE APOYO

1	Camilla rígida	✓		—	
1	Frazada	✓		—	

EL BOTIQUÍN ESTÁ EN UN LUGAR VISIBLE: sí: NO: EL BOTIQUÍN ESTÁ EN BUEN ESTADO: sí: NO:

RECOMENDACIONES:

RESPONSABLE DE LA INSPECCION

F. Mejía S.

ENTREGADO A

Buenaventura Guadalupe S.

Nota: Cada botiquín de primeros auxilios deberá contener la dotación establecida por la Coordinación de SSOMA. El contenido de los botiquines no debe modificarse sin la autorización del Coordinador de SSOMA.

Pautas para realizar una Inspección

- Orientarse por medio de la lista de verificación
- Buscar cada uno de los aspectos que se encuentran allí relacionados

- Escribir e identificar claramente el estado de cada aspecto
- Relacionar los elementos que parecen innecesarios

000009

		CHECKLIST DE CONTROL DEL BOTIQUIN			
		SISTEMA INTEGRADO DE GESTIÓN			
Tipo de Documento		Código	Fecha	Revisión	
FORMATO		SSOMA-FT-10	20/09/2017	00	
FECHA (DD/MM/AA)		22 1 02 1 2019		OBRS	
CANT.	MATERIAL DE CURACIÓN Y APOYO	EXISTENCIA	REPOSICIÓN	FECHA DE VENC.	OBSERVACIONES
2	Paquetes de guantes quirúrgicos	✓		2020	
1	Frasco de yodopovidoma 120 ml solución antiséptico	✓		2020	
1	Frasco de agua oxigenada mediano 120 ml	✓		2020	
1	Frasco de alcohol mediano 250 ml	✓		2020	
5	Paquetes de gasas esterilizadas de 10 cm X 10 cm	✓		2020	
8	Paquetes de apósitos	✓		2020	
1	Rollo de esparadrapo 5 cm X 4,50 m	✓		2020	
2	Rollos de venda elástica de 3 pulg. X 5 yardas	✓		2020	
2	Rollos de venda elástica de 4 pulg. X 5 yardas	✓		2020	
1	Paquete de algodón x 100 g	✓		2020	
1	Venda triangular	✓		2020	
10	Paletas baja lengua (para entablillado de dedos)	✓		2020	
1	Frasco de solución de cloruro de sodio al 9/1000 x 1 l (para lavado de heridas)	✓		2020	
2	Paquetes de gasa tipo jelonet (para quemaduras)	✓		2020	
2	Frascos de colirio de 10 ml	✓		2020	
1	Tijera punta roma	✓		—	
1	Pinza	✓		—	
ELEMENTOS DE APOYO					
1	Camilla rígida	✓		—	
1	Frazada	✓		—	
EL BOTIQUÍN ESTÁ EN UN LUGAR VISIBLE: sí: <input checked="" type="checkbox"/> NO: <input type="checkbox"/> EL BOTIQUÍN ESTÁ EN BUEN ESTADO: sí: <input checked="" type="checkbox"/> NO: <input type="checkbox"/>					
RECOMENDACIONES:					
RESPONSABLE DE LA INSPECCION <u>F. Ureña A.</u> ENTREGADO A <u>Juan Carlos Rivera</u>					
Nota: Cada botiquín de primeros auxilios deberá contener la dotación establecida por la Coordinación de SSOMA. El contenido de los botiquines no debe modificarse sin la autorización del Coordinador de SSOMA.					
Pautas para realizar una Inspección -Orientarse por medio de la lista de verificación -Buscar cada uno de los aspectos que se encuentran allí relacionados -Escribir e identificar claramente el estado de cada aspecto -Relacionar los elementos que parecen innecesarios					

	INSPECCIÓN DE EXTINTORES	Código: SSOMA-FT-09
	DPTO. DE SEGURIDAD, SALUD Y MEDIO AMBIENTE	Versión: 00
		Pág. 01 de 01

OBRA <i>Mejoramiento de la obra</i>	EMPRESA <i>Consorcio Marítimo del Norte</i>	FECHA <i>23/2/19</i>	HORA <i>10:00 AM</i>
ÁREA (UBICACIÓN) <i>Oficina</i>		CÓDIGO DEL EXTINTOR	
		APRUEBA <input checked="" type="checkbox"/>	RECHAZA

TIPO DE FUEGO		TIPO DE EXTINTOR			
1	CLASE A: Fuego de materiales sólidos (madera tejidos, papel, goma, etc.)	ABC	<input checked="" type="checkbox"/>	PQS	<input checked="" type="checkbox"/>
2	CLASE B: Fuego de Líquidos combustibles (pinturas, grasas, solventes, naftas, etc.)	PQS		O2 E.Q.	
3	CLASE C: Fuego de equipos eléctricos bajo tensión, el agente extintor no puede ser conductor de la electricidad.	PQS		CO2	
4	CLASE D: Fuego de ciertos metales combustibles (magnesio, titanio, zirconio, sodio, potasio, etc.)	PQS ESPECIAL			
5	CLASE K: Fuego de aceites vegetales (ej: aceite de cocina)	EXT. De Acetato de potasio			

	DESCRIPCIÓN	CUMPLE				DESCRIPCIÓN	CUMPLE		
		SI	NO	NA			SI	NO	NA
1	Esta el extintor en su lugar?	<input checked="" type="checkbox"/>			4	Tiene el sello de Seguridad?	<input checked="" type="checkbox"/>		
2	Esta completamente cargado y operable?	<input checked="" type="checkbox"/>			5	Tiene Pasador?	<input checked="" type="checkbox"/>		
3	El acceso al extintor esta libre de Obstrucciones?	<input checked="" type="checkbox"/>			6	Manija de descarga en buen estado?	<input checked="" type="checkbox"/>		



Si las respuestas 4 y/o 5 son negativas (el extintor tendra que ser retirado y deribado a su mantenimiento)

7	Verificar el peso en los de bioxido de carbono (si hay perdida de + de 10% de su carga nominal se debera recargar).							<input checked="" type="checkbox"/>
8	La pintura está en buen estado?						<input checked="" type="checkbox"/>	
9	El cilindro presenta oxidación, roturas, abolladuras o golpes?						<input checked="" type="checkbox"/>	
10	La manguera tiene roturas, poros, agrietamientos?						<input checked="" type="checkbox"/>	
11	Están bien los empalmes de la manguera a la válvula y a la corneta o boquilla?						<input checked="" type="checkbox"/>	
12	La corneta (en los extintores de CO2) presenta fisuras, cristalización, y defectos en acoples?						<input checked="" type="checkbox"/>	
13	La válvula presenta oxidación, daños en la manija, deformaciones que impidan su funcionamiento?						<input checked="" type="checkbox"/>	
14	La lectura de presión esta dentro del rango operable?						<input checked="" type="checkbox"/>	
15	Las calcomanías y las placas de instrucción están legibles y en el frente del extintor?						<input checked="" type="checkbox"/>	
16	El gabinete o gancho está ubicado a la altura correspondiente (no mayor a 1.50m). La base del extintor esta al menos a 10 cm de la altura del piso?						<input checked="" type="checkbox"/>	
	En los rodantes se verificará que las carretillas estén bien de pintura, que no presenten oxidación, que los ejes de las ruedas no estén torcidos, que estén bien lubricados y que la carretilla deslice con facilidad.						<input checked="" type="checkbox"/>	<input checked="" type="checkbox"/>
Si la respuesta a las preguntas 7 y 12 es negativa se programa para mantenimiento.						Fecha de mantenimiento		

NOTA: Cada dos (2) meses los extintores de Polvo Químico Seco deberán agitarse balanceándolos e invirtiéndolos en su posición durante un minuto, para garantizar que el agente permanezca con fluidez, sin compactarse.

Sección para SSOMA

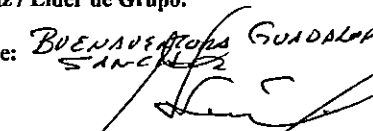
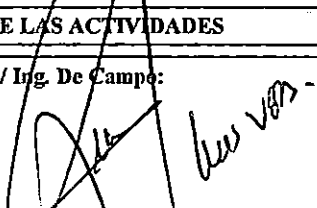
Instrucciones / Recomendaciones:

FIRMA DE APROBACIÓN PARA EL INICIO DE LAS ACTIVIDADES		Vº Bº
Capataz / Lider de Grupo: Nombre: <i>BUENAVENTURA GUADALUPE SANCHEZ</i> Firma: 	Ing. Residente / Ing. De Campo: Nombre: <i>[Signature]</i> Firma: 	Prevencionista de Riesgos: Nombre: <i>F. Mejía A.</i> Firma: 

	INSPECCIÓN DE EXTINTORES	Código: SSOMA-FT-09.º
	DPTO. DE SEGURIDAD, SALUD Y MEDIO AMBIENTE	Versión: 00
		Pág. 01 de 01

OBRA	EMPRESA	FECHA	HORA
Mejoramiento OPA supe	Consorcio Marítimo Del Norte	23/2/2019	10:30 AM
ÁREA (UBICACIÓN)		CÓDIGO DEL EXTINTOR	
Plaza Obra		APRUEBA	RECHAZA
		✓	-

TIPO DE FUEGO		TIPO DE EXTINTOR			
1	CLASE A: Fuego de materiales sólidos (madera tejidos, papel, goma, etc.)	ABC	<input checked="" type="checkbox"/>	PQS	<input checked="" type="checkbox"/>
2	CLASE B: Fuego de Líquidos combustibles (pinturas, grasas, solventes, naftas, etc.)	PQS		O2 E.Q.	
3	CLASE C: Fuego de equipos eléctricos bajo tensión, el agente extintor no puede ser conductor de la electricidad.	PQS		CO2	
4	CLASE D: Fuego de ciertos metales combustibles (magnesio, titanio, zirconio, sodio, potasio, etc.)	PQS ESPECIAL			
5	CLASE K: Fuego de aceites vegetales (ej: aceite de cocina)	EXT. De Acetato de potasio			

	DESCRIPCIÓN	CUMPLE			DESCRIPCIÓN	CUMPLE			
		SI	NO	NA		SI	NO	NA	
1	Esta el extintor en su lugar?	<input checked="" type="checkbox"/>			4	Tiene el sello de Seguridad?	<input checked="" type="checkbox"/>		
2	Esta completamente cargado y operable?	<input checked="" type="checkbox"/>			5	Tiene Pasador?	<input checked="" type="checkbox"/>		
3	El acceso al extintor esta libre de Obstrucciones?	<input checked="" type="checkbox"/>			6	Manija de descarga en buen estado?	<input checked="" type="checkbox"/>		

Si las respuestas 4 y/o 5 son negativos (el extintor tendra que ser retirado y deribado a su mantenimiento)

7	Verificar el peso en los de bioxido de carbono (si hay perdida de + de 10% de su carga nominal se debera recargar).							<input checked="" type="checkbox"/>	
8	La pintura está en buen estado?						<input checked="" type="checkbox"/>		
9	El cilindro presenta oxidación, roturas, abolladuras o golpes?							<input checked="" type="checkbox"/>	
10	La manguera tiene roturas, poros, agrietamientos?							<input checked="" type="checkbox"/>	
11	Están bien los empalmes de la manguera a la válvula y a la corneta o boquilla?						<input checked="" type="checkbox"/>		
12	La corneta (en los extintores de CO2) presenta fisuras, cristalización, y defectos en acoples?						<input checked="" type="checkbox"/>		
13	La válvula presenta oxidación, daños en la manija, deformaciones que impidan su funcionamiento?						<input checked="" type="checkbox"/>		
14	La lectura de presión esta dentro del rango operable?						<input checked="" type="checkbox"/>		
15	Las calcomanías y las placas de instrucción están legibles y en el frente del extintor?						<input checked="" type="checkbox"/>		
16	El gabinete o gancho está ubicado a la altura correspondiente (no mayor a 1.50m). La base del extintor esta al menos a 10 cm de la altura del piso?						<input checked="" type="checkbox"/>		
...	En los rodantes se verificará que las carretillas estén bien de pintura, que no presenten oxidación, que los ejes de las ruedas no estén torcidos, que estén bien lubricados y que la carretilla deslice con facilidad.							<input checked="" type="checkbox"/>	
Si la respuesta a las preguntas 7 y 12 es negativa se programa para mantenimiento.						Fecha de mantenimiento			

NOTA: Cada dos (2) meses los extintores de Polvo Químico Seco deberán agitarse balanceándolos e invirtiéndolos en su posición durante un minuto, para garantizar que el agente permanezca con fluidez, sin compactarse.

Seccion para SSOMA

Instrucciones / Recomendaciones:

FIRMA DE APROBACIÓN PARA EL INICIO DE LAS ACTIVIDADES		Vº Bº
Capataz / Líder de Grupo:	Ing. Residente / Ing. De Campo:	Prevencionista de Riesgos:
Nombre: <i>Ignacio Rucio</i>	Nombre: <i>[Firma]</i>	Nombre: <i>F. Mejía S.</i>
Firma: <i>[Firma]</i>	Firma: <i>[Firma]</i>	Firma: <i>[Firma]</i>

	INSPECCIÓN DE EXTINTORES	Código: SSOMA-FT-09
	DPTO. DE SEGURIDAD, SALUD Y MEDIO AMBIENTE	Versión: 00
		Pág. 01 de 01

OBRA	EMPRESA	FECHA	HORA
Mejoramiento OPA Supe	Concepción Marítima del Norte	23/2/2019	11:00 AM
ÁREA (UBICACIÓN)		CÓDIGO DEL EXTINTOR	
Fierrovia		APRUEBA	RECHAZA
		✓	

TIPO DE FUEGO		TIPO DE EXTINTOR	
1	CLASE A: Fuego de materiales sólidos (madera tejidos, papel, goma, etc.)	ABC	X
2	CLASE B: Fuego de Líquidos combustibles (pinturas, grasas, solventes, naftas, etc.)	PQS	
3	CLASE C: Fuego de equipos eléctricos bajo tensión, el agente extintor no puede ser conductor de la electricidad.	PQS	
4	CLASE D: Fuego de ciertos metales combustibles (magnesio, titanio, zirconio, sodio, potasio, etc.)	PQS ESPECIAL	
5	CLASE K: Fuego de aceites vegetales (ej: aceite de cocina)	EXT. De Acetato de potasio	
		PQS	X
		O2 E.Q.	
		CO2	

	DESCRIPCIÓN	CUMPLE			DESCRIPCIÓN	CUMPLE		
		SI	NO	NA		SI	NO	NA
1	Esta el extintor en su lugar?	X			4	Tiene el sello de Seguridad?	X	
2	Esta completamente cargado y operable?	X			5	Tiene Pasador?	X	
3	El acceso al extintor esta libre de Obstrucciones?	X			6	Manija de descarga en buen estado?	X	

Si las respuestas 4 y/o 5 son negativos (el extintor tendra que ser retirado y deribado a su mantenimiento)

7	Verificar el peso en los de bioxido de carbono (si hay perdida de + de 10% de su carga nominal se debera recargar).				X
8	La pintura está en buen estado?	X			
9	El cilindro presenta oxidación, roturas, abolladuras o golpes?		X		
10	La manguera tiene roturas, poros, agrietamientos?		X		
11	Están bien los empalmes de la manguera a la válvula y a la corneta o boquilla?	X			
12	La corneta (en los extintores de CO2) presenta fisuras, cristalización, y defectos en acoples?	X			
13	La válvula presenta oxidación, daños en la manija, deformaciones que impidan su funcionamiento?	X			
14	La lectura de presión esta dentro del rango operable?	X			
15	Las calcomanías y las placas de instrucción están legibles y en el frente del extintor?	X			
16	El gabinete o gancho está ubicado a la altura correspondiente (no mayor a 1.50m). La base del extintor esta al menos a 10 cm de la altura del piso?	X			
	En los rodantes se verificará que las carretillas estén bien de pintura, que no presenten oxidación, que los ejes de las ruedas no estén torcidos, que estén bien lubricados y que la carretilla deslice con facilidad.				X
Si la respuesta a las preguntas 7 y 12 es negativa se programa para mantenimiento.					Fecha de mantenimiento

NOTA: Cada dos (2) meses los extintores de Polvo Químico Seco deberán agitarse balanceándolos e invirtiéndolos en su posición durante un minuto, para garantizar que el agente permanezca con fluidez, sin compactarse.

Seccion para SSOMA

Instrucciones / Recomendaciones:

FIRMA DE APROBACIÓN PARA EL INICIO DE LAS ACTIVIDADES		Vº Bº
Capataz / Líder de Grupo:	Ing. Residente / Ing. De Campo:	Prevencionista de Riesgos:
Nombre: Domingo Rivera S	Nombre: [Firma]	Nombre: F. Mejía A.
Firma: [Firma]	Firma: [Firma]	Firma: [Firma]

000005

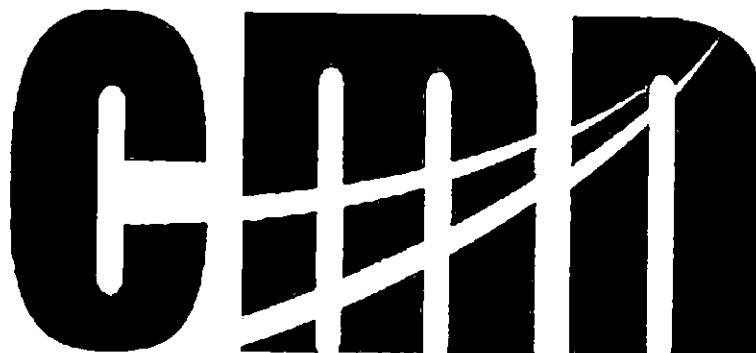

CONSORCIO MARITIMO DEL NORTE

10. ENTREGA DE EPP

CONSORCIO MARITIMO DEL NORTE
DESEMBARCADERO ARTESANAL DE SUPE

DANIEL JOAQUIN MORALES VIVA 4CC
RESIDENTE DE OBRA /
REG. CIP N° 98098



CONGRESO HAITIANO DEL NORTE

Código

LOG-FT-06

Fecha

1/09/2017

CONTROL DE ENTREGA DE EQUIPOS DE PROTECCIÓN PERSONAL

SISTEMA INTEGRADO DE GESTIÓN

NOMBRE DEL TRABAJADOR:

Chabellio BRAVO SANOEL CIRIO

DNI:

3273 01 89

CARGO:

Oficinero - Alskali

EQUIPOS DE PROTECCIÓN PERSONAL

	Pantalón drill con cintas reflectivas	Polo manga larga	Casco	Guantes de cuero	Guantes Badana	Guantes de jebe	Guantes de Hilo	zapatos punta de acero	Respirador	Filtros para polvo	Tapones auditivos	Chaleco	Capotines	Botas de jebe	Orejera	Lentes de seguridad	Barbiquejo	Cortaviento	Pantalon	FECHA DE ENTREGA	FIRMA
✓																				<i>22/11/18</i>	<i>[Signature]</i>
																				<i>29/11/18</i>	<i>[Signature]</i>
																				<i>13/12/18</i>	<i>[Signature]</i>
✓																				<i>02/01/19</i>	<i>[Signature]</i>
																				<i>11/01/19</i>	<i>[Signature]</i>
																				<i>05/01/19</i>	<i>[Signature]</i>
																				<i>13/01/19</i>	<i>[Signature]</i>
																				<i>22/01/19</i>	<i>[Signature]</i>



CONTROL DE ENTREGA DE EQUIPOS DE PROTECCIÓN PERSONAL

SISTEMA INTEGRADO DE GESTIÓN

Tipo de documento
Formato

Código
LOG-FT-06

Fecha
1/09/2017

NOMBRE DEL TRABAJADOR: HUAMAN SOTOMAYOR GREGORIO DNI: 41942549 CARGO: ENCHAPADOR-OPERARIO

EQUIPOS DE PROTECCION PERSONAL

Pantalón drill con cintas reflectivas	Polo manga larga	Casco	Gautes de cuero	Gautes Badana	Gautes de jebe	Gautes de Hilo nitrilo	zapatos punta de acero	Respirador	Filtros para polvo	Tapones auditivos	Chaleco	Capotines	Botas de jebe	Orejera	Lentes de seguridad	Barbiquejo	Cortaviento	Traje tyben	FECHA DE ENTREGA	FIRMA
✓	✓	✓				✓									✓	✓	✓		19/12/18	
✓	✓					✓									4 años 21				02/08/19	
						✓													12/07/19	
				✓		✓									25.10 37				04/02/19	
						✓													17/02/19	
																			18/02/19	

000000

